

# Quantum<sup>®</sup>

## User's Guide

# Quantum DXi6900

with DXi 3.2.2 (DXi6900) and DXi 3.2.4.1  
(DXi6900-S) Software



Quantum DXi6900 User's Guide, 6-68446-03 Rev A, October 2016, Product of USA.

Quantum Corporation provides this publication "as is" without warranty of any kind, either express or implied, including but not limited to the implied warranties of merchantability or fitness for a particular purpose. Quantum Corporation may revise this publication from time to time without notice.

## **COPYRIGHT STATEMENT**

© 2016 Quantum Corporation. All rights reserved.

Your right to copy this manual is limited by copyright law. Making copies or adaptations without prior written authorization of Quantum Corporation is prohibited by law and constitutes a punishable violation of the law.

## **TRADEMARK STATEMENT**

Artico, Be Certain (and the Q brackets design), DLT, DXi, DXi Accent, DXi V1000, DXi V2000, DXi V4000, GoVault, Lattus, NDX, the Q logo, the Q Quantum logo, Q-Cloud, Quantum (and the Q brackets design), the Quantum logo, Quantum Be Certain (and the Q brackets design), Quantum Vision, Scalar, StorageCare, StorNext, SuperLoader, Symform, the Symform logo (and design), vmPRO, and Xcellis are either registered trademarks or trademarks of Quantum Corporation and its affiliates in the United States and/or other countries. All other trademarks are the property of their respective owners.

Products mentioned herein are for identification purposes only and may be registered trademarks or trademarks of their respective companies. All other brand names or trademarks are the property of their respective owners.

Quantum specifications are subject to change.



# Contents

---

Preface .....	10
<b>Chapter 1: System Description .....</b>	<b>15</b>
Overview .....	16
Advanced Data Deduplication Increasing Disk Retention for Backup Data .....	16
Remote Replication of Backup Data Providing Automated Disaster Recovery Protection .....	16
Enterprise Features Provide Secure Repository .....	16
Features and Benefits .....	17
Determining the DXi6900 Model .....	18
Data Reduction .....	20
Data Deduplication .....	20
Compression .....	20
Space Reclamation .....	21
Remote Replication .....	21
DXi6900 System .....	21
Drive Storage .....	24
DXi Usage Scenarios .....	24

HDDs .....	25
SDDs .....	27
Virtual Tape Storage .....	28
Network Attached Storage (NAS) .....	29
OpenStorage (OST) .....	31
Supported RAID Configurations .....	32
RAID 1 Configuration .....	32
RAID 6 Configuration .....	33
Dynamic Disk Pool (DDP) Technology .....	34
DXi Advanced Reporting .....	35
Network Configuration .....	35
Best Practices .....	36
Licensing .....	36
Virtual Media—How Many and What Size? .....	39
<b>Chapter 2: Basic Operations .....</b>	<b>41</b>
DXi6900 Node .....	41
DXi6900 Node Front Panel Features and Indicators .....	42
DXi6900 Node Rear Panel Features .....	45
Node Drive Carrier Indicators .....	50
DXi6900 Node 1 GbE Ethernet .....	51
DXi6900 Node 10 GbE Ethernet Port Indicators .....	52
DXi6900 Node 10 GBase-T Ethernet Port Indicators .....	52
DXi6900 Node Power Supply Indicators .....	53
DXi6900 Array and Expansion Modules .....	54
DXi6900 Array and Expansion Module Front Panel Features and Indicators .....	55
Array and Expansion Module Hard Drive Carrier Indicators .....	56
Array Module Rear Panel Indicators .....	57
Expansion Module Rear Panel Indicators .....	59

Turning On and Shutting Down the DXi6900 .....	60
Turning On the DXi6900 .....	61
Turning Off the DXi6900 .....	62
Locating DXi6900 Serial Numbers .....	62
<b>Chapter 3: Remote Management .....</b>	<b>64</b>
DXi6900 Remote Management Overview .....	64
Accessing Remote Management .....	65
The Remote Management Console .....	70
<b>Chapter 4: Configuration Wizards .....</b>	<b>79</b>
Configuration Wizards .....	79
NAS Wizard (DXi6900) .....	81
NAS Wizard (DXi6900-S) .....	87
VTL Wizard .....	94
OST Wizard .....	102
Replication Wizard .....	108
Email Alerts Wizard .....	115
Support Wizard .....	120
<b>Chapter 5: Home Page .....</b>	<b>125</b>
Home Page .....	125
System Overview .....	127
Disk Usage .....	128
Data Reduction Statistics .....	130
Replication .....	131
Current Activity .....	134
<b>Chapter 6: Replication .....</b>	<b>138</b>
Replication .....	138

Replication Send .....	145
Receive NAS .....	153
Receive VTL .....	163
Actions .....	173
Reports .....	176
<b>Chapter 7: Status .....</b>	<b>177</b>
Status .....	177
Hardware .....	178
Performance .....	185
Disk Usage .....	190
VTL Status .....	193
Accent Status (DXi6900-S) .....	197
OST Status .....	199
DXi6900 .....	200
DXi6900-S .....	201
Activity Log .....	201
<b>Chapter 8: Alerts .....</b>	<b>205</b>
Alerts .....	205
Admin Alerts .....	206
Service Tickets .....	207
<b>Chapter 9: Configuration .....</b>	<b>214</b>
DXi6900 Configuration Overview .....	214
NAS Configuration .....	215
NAS Summary .....	216
Windows Domain .....	223
Share Access .....	225
Advanced Setting .....	230

VTL Configuration .....	231
Partitions .....	231
Media .....	240
Remote Host Access .....	248
OST Configuration .....	257
Replicating OST Data .....	258
Storage Servers .....	260
LSU .....	266
Manage Users (DXi6900) .....	272
Manage Remote Users .....	275
Target IP Mapping .....	278
DXi Accent .....	281
OST Client Plug-In (DXi6900) .....	282
Replication Configuration .....	282
PTT Configuration .....	291
Physical Device Discovery .....	292
Backup Application Specific (DXi6900) .....	293
Scheduler .....	297
Notifications .....	304
Email .....	304
SNMP .....	312
System .....	321
Network .....	322
Date & Time .....	333
Security .....	335
Manage Users (DXi6900-S) .....	357
Client Plug-Ins (DXi6900-S) .....	360
FC Initiators and Targets .....	362
Contacts .....	363

Company .....	363
Primary and Secondary .....	364
<b>Chapter 10: Utilities .....</b>	<b>366</b>
DXi6900 Utilities Overview .....	366
Diagnostics .....	367
Analyzer .....	372
Space Reclamation .....	374
License Keys .....	377
Secure Shred .....	382
Software Upgrades .....	384
Reboot & Shutdown .....	391
<b>Chapter 11: System Specifications .....</b>	<b>393</b>
DXi6900 Physical Characteristics .....	393
DXi6900 G1 Physical Characteristics .....	394
DXi6900 G2 Physical Characteristics .....	394
DXi6900-S Physical Characteristics .....	394
DXi6900 Storage Capacity .....	395
DXi6900 Cable Drops .....	396
Virtual Device Limits and Hardware Interfaces .....	398
DXi6900 G1 Power Requirements .....	399
DXi6900 G2 Power Requirements .....	400
DXi6900-S Power Requirements .....	401
DXi6900 Environmental Specifications .....	403
DXi6900 Environmental Specifications .....	403
<b>Chapter 12: Troubleshooting .....</b>	<b>405</b>
DXi6900 Status and Problem Reporting .....	405
General Troubleshooting .....	406



Viewing Service Tickets .....	406
Checking Hardware Status .....	406
Downloading a System Diagnostics File .....	407
Common Problems and Solutions .....	407
Start-up Problems .....	407
Hardware Problems .....	407
Ethernet Network Problems .....	409
Replication Problems .....	410
Temperature Problems .....	410



# Preface

This manual introduces the Quantum DXi6900 disk backup solution and discusses:

- System operations
- Configuration
- Web interface
- Basic troubleshooting
- Service menus and FRU replacement

## Audience

This manual is written for Quantum DXi6900 operators, system administrators, and field service engineers

---

**i Note:** It is useful for the audience to have a basic understanding of UNIX® and backup/recovery systems.

# Notational Conventions

This manual uses the following conventions:

Convention	Example
User input is shown in bold monospace font.	<b>./DARTinstall</b>
Computer output and command line examples are shown in monospace font.	./DARTinstall
User input variables are enclosed in angle brackets.	<b>http://&lt;ip_address&gt;/cgi-bin/stats</b>
For UNIX and Linux commands, the command prompt is implied.	./DARTinstall is the same as # ./DARTinstall
File and directory names, menu commands, button names, and window names are shown in bold font.	<b>/data/upload</b>
Menu names separated by arrows indicate a sequence of menus to be navigated.	<b>Utilities &gt; Firmware</b>

The following formats indicate important information:

 **Note:** Note emphasizes important information related to the main topic.

 **Caution:** Caution indicates potential hazards to equipment or data.

 **WARNING:** Warning indicates potential hazards to personal safety.

- Right side of the system - Refers to the right side as you face the component being described.
- Left side of the system - Refers to the left side as you face the component being described.
- Data sizes are reported in base 1000 rather than base 1024. For example:
  - 1 MB = 1,000,000 bytes
  - 1 GB = 1,000,000,000 bytes
  - 1 TB = 1,000,000,000,000 bytes

## Product Safety Statements

Quantum will not be held liable for damage arising from unauthorized use of the product. The user assumes all risk in this aspect.

This unit is engineered and manufactured to meet all safety and regulatory requirements. Be aware that improper use may result in bodily injury, damage to the equipment, or interference with other equipment.

- 
- ⚡ WARNING:** Before operating this product, read all instructions and warnings in this document and in the *Quantum Products System, Safety, and Regulatory Information Guide*.
- 
- ⚡ ADVARSEL:** Læs alle instruktioner og advarsler i dette dokument og i *Informationsvejledning vedrørende system-, sikkerheds- og lovbestemmelser for Quantum produkter, før produktet betjenes*.
- 
- ⚡ AVERTISSEMENT :** Avant d'utiliser ce produit, lisez toutes les instructions et les avertissements de ce document et du *Guide d'informations sur le système, la sécurité et la réglementation de Quantum*.
- 
- ⚡ WARNUNG:** Lesen Sie vor der Inbetriebnahme dieses Produkts alle Anleitungen und Warnungen in diesem Dokument und im *System-, Sicherheits- und Betriebsbestimmungen-Handbuch für Quantum-Produkte*.
- 
- ⚡ ADVERTENCIA:** Antes de hacer funcionar este producto, lea todas las instrucciones y advertencias de este documento y de la *Guía de información normativa, del sistema y de seguridad de los productos de Quantum*.
- 
- ⚡ WARNING:** Läs igenom alla instruktioner och varningar i detta dokument och i *Quantums produktsystem, säkerhet och reglerande informationsguide* innan denna produkt används.
- 
- ⚡ ВНИМАНИЕ!** Перед началом эксплуатации данного изделия прочтите все инструкции и предупреждения, приведенные в настоящем документе и в *Руководстве по системе, технике безопасности и действующим нормативам компании Quantum*.
- 
- ⚡ 警告：**本製品を使用される前に、本書と『Quantum製品システム、安全、規制情報ガイド』に記載されているすべての説明と警告をお読みください。
- 
- ⚡ 경고:** 본 제품을 작동하기 전에 본 문서와 *Quantum 제품 시스템, 안전 및 규제 정보 설명서*에 있는 모든 지침과 경고를 참조합니다.
- 
- ⚡ 警告：**在操作本产品之前，请阅读本文档和 *Quantum 产品系统、安全和法规信息指南*中的所有说明和警告。
- 
- ⚡ 警告：**操作此產品前，請閱讀本檔案及 *Quantum 產品系統、安全與法規資訊指南*中的指示與和警告說明。

---

**⚡ אזהרה:** לפני ההפעלה של מוצר זה, קרא את כל ההוראות והאזהרות הכלולות במסמך זה וכן במדריך המידע בנושא מערכת, בטיחות ותקינה עבור מוצרי Quantum.

## Contacts

For information about contacting Quantum, including Quantum office locations, go to:

<http://www.quantum.com/aboutus/contactus/index.aspx>

## Comments

To provide comments or feedback about this document, or about other Quantum technical publications, send e-mail to:

[doc-comments@quantum.com](mailto:doc-comments@quantum.com)

## Getting More Information or Help

StorageCare™, Quantum’s comprehensive service approach, leverages advanced data access and diagnostics technologies with cross-environment, multi-vendor expertise to resolve backup issues faster and at lower cost.

Accelerate service issue resolution with these exclusive Quantum StorageCare services:

- **Service and Support Website** - Register products, license software, browse Quantum Learning courses, check backup software and operating system support, and locate manuals, FAQs, firmware downloads, product updates and more in one convenient location. Get started at:  
<http://www.quantum.com/serviceandsupport/index.aspx>
- **eSupport** - Submit online service requests, update contact information, add attachments, and receive status updates via email. Online Service accounts are free from Quantum. That account can also be used to access Quantum’s Knowledge Base, a comprehensive repository of product support information. Get started at:  
<https://onlineservice.quantum.com>
- **StorageCare Guardian** - Securely links Quantum hardware and the diagnostic data from the surrounding storage ecosystem to Quantum’s Global Services Team for faster, more precise root cause diagnosis. StorageCare Guardian is simple to set up through the internet and provides secure, two-way communications with Quantum’s Secure Service Center. Learn more at:  
<http://www.quantum.com/ServiceandSupport/Services/GuardianInformation/Index.aspx>

For further assistance, or if training is desired, contact the Quantum Customer Support Center:

Region	Support Contact
North America	1-800-284-5101 (toll free) +1-720-249-5700
EMEA	+800-7826-8888 (toll free) +49 6131 324 185
Asia Pacific	+800-7826-8887 (toll free) +603-7953-3010

For worldwide support:

<http://www.quantum.com/serviceandsupport/index.aspx>

# Worldwide End-User Product Warranty

For more information on the Quantum Worldwide End-User Standard Limited Product Warranty:

<http://www.quantum.com/serviceandsupport/warrantyinformation/index.aspx>



# Chapter 1: System Description

---

This chapter describes the DXi6900 system and its components and includes the following sections:

Overview .....	16
Features and Benefits .....	17
Determining the DXi6900 Model .....	18
Data Reduction .....	20
Space Reclamation .....	21
Remote Replication .....	21
DXi6900 System .....	21
Drive Storage .....	24
Supported RAID Configurations .....	32
DXi Advanced Reporting .....	35
Network Configuration .....	35
Best Practices .....	36

## Overview

The DXi6900 is Quantum's Enterprise disk backup solution that integrates data deduplication, replication, and direct tape creation technology to connect backup and disaster recovery protection across distributed corporate environments. The DXi6900 disk-based backup appliance uses Quantum's patented data deduplication technology to increase disk capacities by 10 to 50 times, and make WAN replication a practical, cost-effective part of disaster recovery planning. Scalable to 510 TB (DXi6900) or 544 TB (DXi6900-S) usable capacity, the DXi6900 is designed for larger sites and corporate data centers.

## Advanced Data Deduplication Increasing Disk Retention for Backup Data

The DXi6900 leverages Quantum's patented data deduplication technology to dramatically increase the role that disk can play in the protection of critical data. With the DXi6900 solution, users can retain 10 to 50 times more backup data on fast recovery disk than with conventional arrays.

## Remote Replication of Backup Data Providing Automated Disaster Recovery Protection

With the DXi6900, users can transmit backup data from a remote site to a central, secure location to reduce or eliminate media handling. DXi™-Series replication is asynchronous, automated, and operates as a background process.

## Enterprise Features Provide Secure Repository

With up to 510 TB (DXi6900) or 544 TB (DXi6900-S) usable capacity, the DXi6900 supports large-scale Enterprise environments. Presentations include both VTL (Fibre Channel) and NAS (CIFS and NFS) as well as Symantec OpenStorage (OST) and Oracle® Recovery Manager (RMAN)<sup>1</sup> APIs. Integrated tape creation writes physical media directly over dedicated Fibre Channel connections, and supports ISV direct tape creation in NetBackup, Backup Exec, NetWorker, Oracle Secure Backup, and ASG-Time Navigator.

DXi Accent distributes deduplication between the DXi6900 and the backup server to accelerate backups over bandwidth-constrained networks. Compatibility with Quantum's vmPRO software provides consolidated support for backup of physical and virtual servers.

In addition, DXi6900 systems optionally support Data-at-Rest Encryption to secure all data stored on the DXi6900. Data-at-Rest Encryption ensures that a hard drive that is physically removed from the DXi6900 cannot be read using another system or device.

---

**i Note:** DXi6900-S systems support Data-at-Rest encryption to secure all data stored on the Array module (RBOD) and Expansion module (EBOD) bulk data storage disks.



1. Available on DXi6900-S systems

---

# Features and Benefits

The DXi6900 system provides the following features and benefits:

- Inline data flow provides leading deduplication with an optimal combination of total system performance, manageability, and value.
  - Flexibility of VTL, NAS, and OST (OpenStorage) presentation layers.
  - High throughput connectivity options (10 GbE Twinax, Optical, and 10 GBase-T, and 16 Gb Fibre Channel).
  - 10 source to one target LAN/WAN replication compatible with DXi2500-D, DXi4000 family, DXi6000 family, DXi7500, and DXi8500 models.
  - Common monitoring and management interface for multiple DXi™ units and Quantum tape libraries through Quantum Vision™.
  - OST Optimized Duplication support with Symantec NetBackup™ 7.1.x or later or Symantec Backup Exec™ 2010 R3 or later.
  - Oracle RMAN™ support for Oracle 11 (DXi6900-S only)
  - Path to tape (PTT) capability that writes data from virtual cartridges directly to a tape library to create removable media for long term retention. It is supported by:
    - Symantec™ NetBackup™ (under VTL and OST implementations)
    - Symantec Backup Exec
    - Oracle® Secure Backup
    - ASG-Time Navigator™
    - EMC® Networker® (versions prior to 8.1)
- 
- i Note:** When the path to tape feature is enabled and configured, backup data can be moved directly from the DXi6900 system to a tape library. For a list of supported tape libraries and tape drives, see Table 1 on page 21 and Table 2 on page 21.
- OST direct path to tape support with Symantec NetBackup™ 7.1.x or later.
  - Tape Drives Emulated:
    - Quantum DLT-S4, SDLT600, SDLT320, or DLT7000
    - Certance LTO-2 and LTO-3
    - IBM LTO-1, LTO-2, LTO-3, LTO-4, LTO-5, LTO-6
    - HP LTO-1, LTO-2, LTO-3, LTO-4, LTO-5, LTO-6

- Libraries Emulated:
  - Quantum DXi7500
  - ADIC Scalar 100, ADIC Scalar i2000, or ADIC Scalar i500
  - ADIC Pathlight VX
  - Quantum Scalar i40/i80 or Quantum Scalar i6000
  - Quantum DXi6700, Quantum DXi6902, Quantum DXi6800, Quantum DXi4700, Quantum DXi4601, QuantumDXi4500, or Quantum DXi8500
  - Quantum DX3000 or Quantum DX5000
  - Quantum PX500 or Quantum PX720
  - ATL M2500, ATL P1000, or ATL P7000
- Supported by every major backup software vendor.
- Rack space requirements: 2U for Node and 2U for each Array module (RBOD) and Expansion module (EBOD).
- Installs in a standard rack with a minimum depth of 29.79 in (75.68 cm).

---

**i Note:** Quantum recommends installing the DXi6900 system in a controlled or restricted area and using strong, private passwords to prevent access by untrained personnel. In addition, Quantum recommends that system installation be performed only by qualified IT personnel with strong networking experience.

---

## Determining the DXi6900 Model

You will need to determine if the DXi system is a DXi6900 G1, DXi6900 G2, or DXi6900-S. Model information is located on the pull-out information tag on the front of the Node (see [Figure 1 on the next page](#)).

- The DXi6900-S information tag includes "S" in the part number (see [Figure 2 on the next page](#)).
- The DXi6900 G2 information tag includes "G2" in the part number (see [Figure 3 on the next page](#)).
- The DXi6900 G1 information tag does not include "G1" in the part number (see [Figure 4 on page 20](#)).

Figure 1: DXi6900 Information Tag

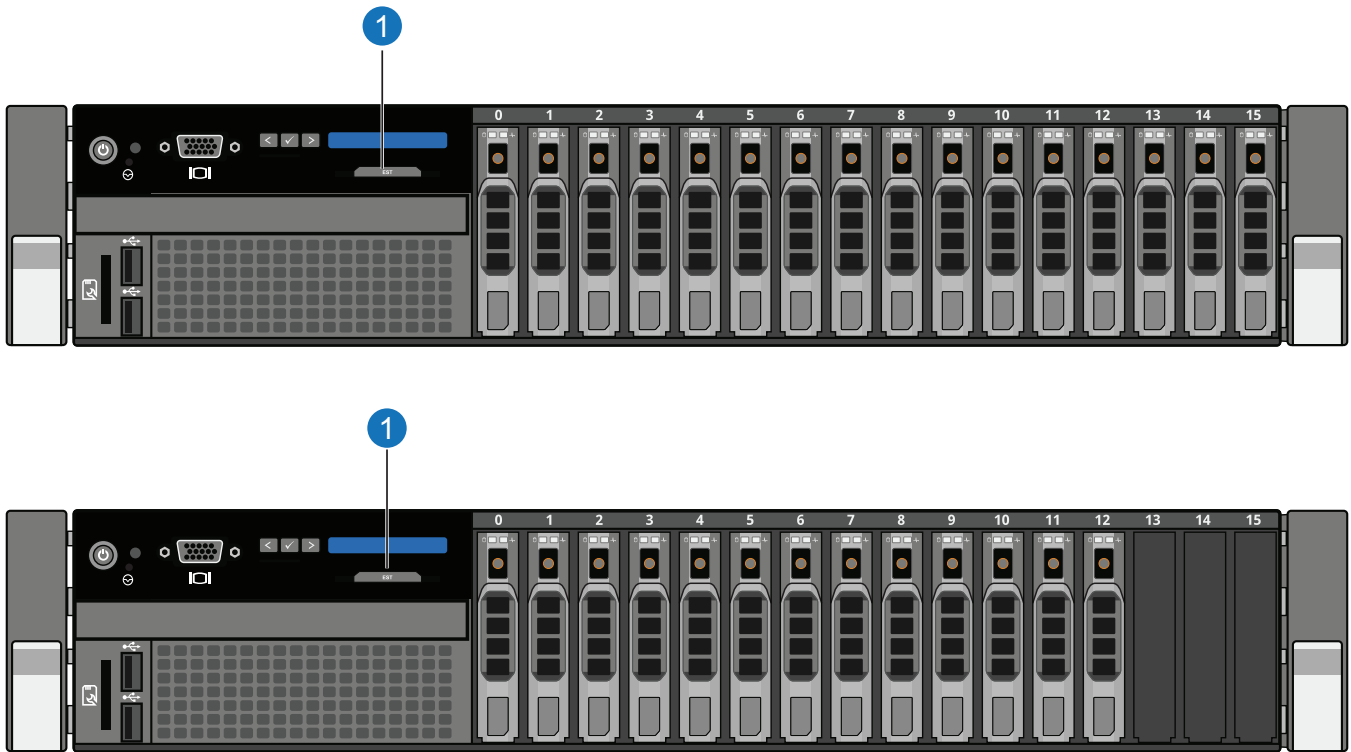

1. Information Tag

Figure 2: DXi6900-S Information Tag

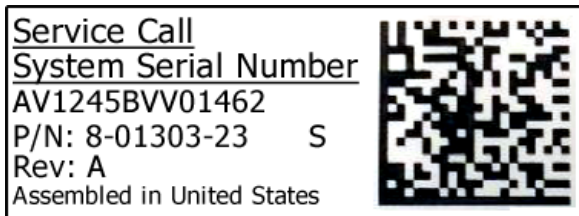
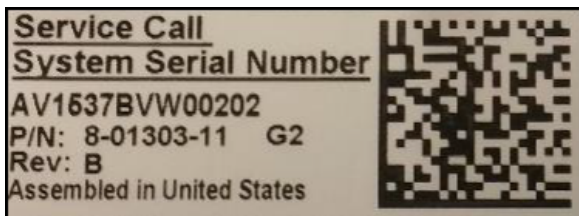
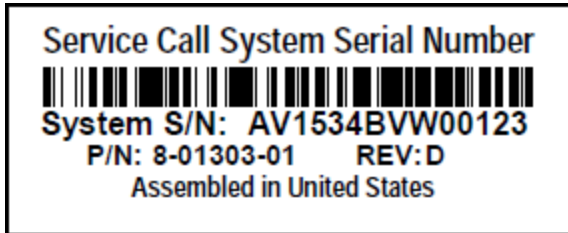

Figure 3: DXi6900 G2 Information Tag



**Figure 4:** DXi6900 G1 Information Tag



---

## Data Reduction

Data reduction is the process of reducing the amount of storage capacity required to store your data. The DXi6900 systems provide two techniques to optimize the storage space required on your system:

- [Data Deduplication below](#)
- [Compression below](#)

## Data Deduplication

The DXi-Series disk backup and replication systems use Quantum's patented data deduplication technology to dramatically increase the role that disk can play in data protection. With DXi-Series solutions, users can retain 10 to 50 times more backup data on fast recovery disk than with conventional arrays. This advantage allows IT departments to cost-effectively retain months of backup data on disk for faster, more reliable restores and more data recovery points. Quantum's innovative implementation of this core technology means that users do not have to compromise on performance to take advantage of extended retention capability. Inline data flow provides streamlined deduplication that offers a maximum combination of total system performance, manageability, and value.

Quantum's deduplication technology uses a sub-file, variable-length approach to identify redundant blocks in a data stream—blocks that have appeared before in the same dataset or in datasets processed at an earlier time. When a block appears that has already been stored, the DXi system inserts a reference pointer to the earlier instance of the data segment instead of storing another copy. The result is a dramatic reduction in the storage capacity needed to store the data set, and a similar reduction in the bandwidth needed to replicate deduplicated data sets over a network.

## Compression

The DXi6900 systems use compression technology after duplicate blocks have been identified and replaced as part of the deduplication process. With compression, unique data that has been through the data deduplication process can be compressed at a typical ratio of approximately 2:1. This enables you to maximize the storage capacity of your system.

# Space Reclamation

The space reclamation process performs multiple functions on the DXi6900.

When data is deduplicated it is stored in a block pool—a pool of all unique data blocks that were captured during the data deduplication cycle. When subsequent backup jobs occur, the data deduplication engine searches for new data entering the DXi and uses a variable length compression algorithm to compare new data to existing data in the block pool. Unique blocks are added to the block pool and known blocks are indexed.

The space reclamation function searches the blockpool for data blocks that are not referenced by any pointers (that is, the files associated with the block have been expired and removed). Once such a data block is identified, the block is removed to make the space reusable.

For correct system operation, space reclamation *must* be run at regular intervals (at least once a week). Quantum recommends creating a schedule to automatically run space reclamation (see ).

It may be beneficial to schedule space reclamation for a time when other operations are not normally being carried out. Therefore it is important to know when to schedule the space reclamation process. As best practice it is recommended that this process commences at least two hours after your backup job has completed on a daily basis. It is far more efficient to process a day's worth of new data than a week's worth.

---

# Remote Replication

Today most backup occurs on isolated devices, making it difficult to deploy disk backup when disaster recovery protection is required. DXi-Series solutions use data deduplication and replication to decrease by up to 50 times the bandwidth required to move backup data over networks and between sites. This dramatic gain makes it practical and cost-effective for users to replicate backup data over WANs for secure, network-based disaster recovery protection, and it lets users combine rapid, local restores with sound disaster recovery protection.

With DXi-Series replication, users can transmit data from a single site or multiple sites to a central location using any DXi model. DXi-Series replication is an asynchronous, automated background process that includes encryption of data in transit. This model for protecting the distributed enterprise allows users to combine disk, replication, and tape for an optimal combination of performance, simplicity, and security.

For more information on implementing a replication plan, see [Remote Replication](#).

---

# DXi6900 System

## DXi6900 G1 Features

The DXi6900 G1 includes the following features:

Feature	Description
<b>Node</b>	1 Node
<b>Array modules (RBOBs)</b>	1 or 2 Array modules (RBODs)
<b>Expansion modules (EBODs)</b>	0 to 13 Expansion modules (EBODs)
<b>Network Connectivity</b>	<ul style="list-style-type: none"><li>• 3 x 1 GbE ports</li><li>• 2 x 10 GbE ports (optical or Twinax)</li><li>• (Optional) One of the following additional network connectivity options:<ul style="list-style-type: none"><li>◦ 4 x 1GbE ports</li><li>◦ 2 x 10 GbE ports</li><li>◦ 2 x 10 GBase-T ports</li></ul></li></ul>
<b>Fibre Channel</b>	6 x 8 Gb Fibre Channel ports (4 for VTL and 2 for path to tape, also configurable for VTL) or 4 x 16 Gb Fibre Channel ports (for path to tape or VTL)
<b>Usable Capacity</b>	17 TB to 510 TB usable capacity

### DXi6900 G2 Features

The DXi6900 G2 includes the following features:

Feature	Description
<b>Node</b>	1 Node
<b>Array modules (RBOBs)</b>	1 or 2 Array modules (RBODs)
<b>Expansion modules (EBODs)</b>	0 to 13 Expansion modules (EBODs)
<b>Network Connectivity</b>	<ul style="list-style-type: none"><li>• 3 x 1 GbE ports</li><li>• (Optional) One of the following additional network connectivity options:<ul style="list-style-type: none"><li>◦ (Optional) Up to an additional 6 x 10 GbE Ethernet ports (optical or Twinax).</li><li>◦ (Optional) Up to an additional 6 x 10 GBase-T Ethernet ports.</li></ul></li></ul>
<b>Fibre Channel</b>	Up to an additional 6 x 16 Gb Fibre Channel ports (for path to tape and VTL)
<b>Usable Capacity</b>	17 TB to 510 TB usable capacity

### DXi6900-S Features

The DXi6900-S includes the following features:

Feature	Description
<b>Node</b>	1 Node
<b>Array modules (RBOBs)</b>	1 or 2 Array modules (RBODs)
<b>Expansion modules (EBODs)</b>	0 to 6 Expansion modules (EBODs)
<b>Network Connectivity</b>	<ul style="list-style-type: none"><li>• 3 x 1 GbE ports</li><li>• (Optional) One of the following additional network connectivity options:<ul style="list-style-type: none"><li>◦ (Optional) Up to an additional 6 x 10 GbE Ethernet ports (optical or Twinax).</li><li>◦ (Optional) Up to an additional 6 x 10 GBase-T Ethernet ports.</li></ul></li></ul>
<b>Fibre Channel</b>	Up to an additional 6 x 16 Gb Fibre Channel ports (for path to tape and VTL)
<b>Usable Capacity</b>	34 TB to 544 TB usable capacity

### Additional Storage Capacity

Usable storage capacity for installed Array or Expansion modules can be upgraded at any time after purchase in the following increments:

- 17 TB, up to a total of 34 TB per module for DXi6900 systems.
- 34 TB, up to a total of 68 TB per module for DXi6900-S systems.

Usable storage To purchase a storage capacity upgrade license, contact your Quantum sales representative.

**Figure 5:** DXi6900 System



1. DXi6900 Node    2. Array Module (RBOD)/Expansion Module (EBOD)

---

## Drive Storage

The DXi6900 system is based upon high speed disk drives instead of tape drives (see [HDDs on the next page](#)). The usable capacity is 17–510 TB.

The DXi6900-S system is based upon solid state drives in the Node (see [SDDs on page 27](#)) and high speed disk drives in the Array and Expansion Modules (see [HDDs on the next page](#)). The usable capacity is 34–544 TB.

The DXi6900 can present its drive storage using multiple protocols:

- [Virtual Tape Storage on page 28](#)
- [Network Attached Storage \(NAS\) on page 29](#)
- [OpenStorage \(OST\) on page 31](#)

By making use of high speed drives, the DXi6900 greatly reduces the time required for backup/restore functions and improves confidence in completing the backup in the time allowed.

## DXi Usage Scenarios

DXi storage presentations are optimized for backup usage rather than file sharing. Backup application usage is typically characterized by:



- Aggregated name spaces and file contents.
- Limited direct, active file access.
- Limited browsing, scanning, or stating.
- Limited metadata manipulation (including rename).

Usage diverging from these characteristics must be qualified to ensure acceptable behavior with respect to functionality, performance, replication, and recovery.

**i Note:** Using Backup Exec with GRT (Granular Recovery Technology) over CIFS is not recommended usage. GRT requires frequently overwriting portions of and appending data to existing files, which is inconsistent with the DXi usage scenarios. Instead, Quantum recommends using OST.

## HDDs

The DXi6900 G1 and G2 Nodes support sixteen high capacity (900 GB for G1/1.2 TB for G2) hard disk drives (HDDs) (see [Figure 6 on the next page](#)).

The Node hard drives are used for the operating system, system software, and indexes needed for data deduplication, replication, and space reclamation.

The DXi6900 Array modules (RBODs) and Expansion modules (EBODs) each support twelve high capacity (4 TB for DXi6900 G1/G2 and 8 TB for DXi6900-S) hard disk drives (see [Figure 8 on page 27](#) and [Figure 9 on page 27](#)). The Array and Expansion module hard drives are used for data storage.

All hard disk drives are mounted and pre-assembled in drive carriers (see [Figure 6 on the next page](#) and [Figure 7 on the next page](#)). All drives are hot swappable.

### Additional Information - DXi6900-S

- The DXi6900-S Node supports thirteen high capacity solid state drives (SDDs) (see [SDDs on page 27](#)).
- The DXi6900-S 8 TB Array module (RBOD) and Expansion module (EBOD) hard disk drives cannot be used in DXi6900 G1/G2 systems.

**Figure 6:** DXi6900 G1/G2 Node Drive Slot Numbering

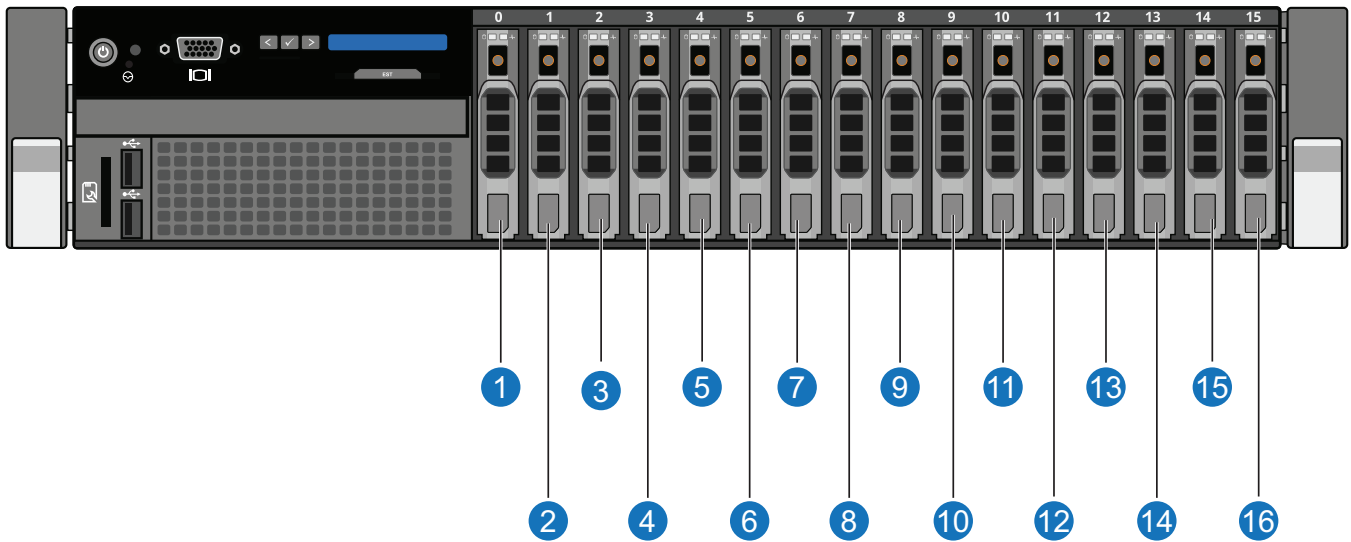

- |                       |                       |                         |                         |
|-----------------------|-----------------------|-------------------------|-------------------------|
| <b>1 - HDD Slot 0</b> | <b>5 - HDD Slot 4</b> | <b>9 - HDD Slot 8</b>   | <b>13 - HDD Slot 12</b> |
| <b>2 - HDD Slot 1</b> | <b>6 - HDD Slot 5</b> | <b>10 - HDD Slot 9</b>  | <b>14 - HDD Slot 13</b> |
| <b>3 - HDD Slot 2</b> | <b>7 - HDD Slot 6</b> | <b>11 - HDD Slot 10</b> | <b>15 - HDD Slot 14</b> |
| <b>4 - HDD Slot 3</b> | <b>8 - HDD Slot 7</b> | <b>12 - HDD Slot 11</b> | <b>16 - HDD Slot 15</b> |

**Figure 7:** DXi6900 Array and Expansion Module Drive Slot Numbering

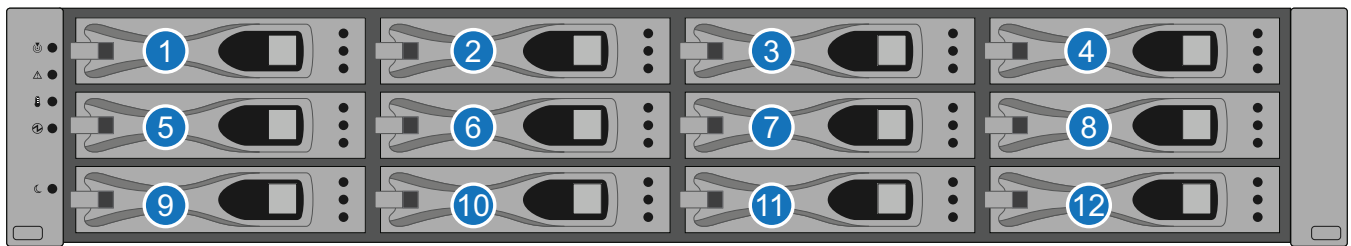

- |                       |                        |                        |                         |
|-----------------------|------------------------|------------------------|-------------------------|
| <b>1 - HDD Slot 1</b> | <b>4 - HDD Slot 2</b>  | <b>7 - HDD Slot 3</b>  | <b>10 - HDD Slot 4</b>  |
| <b>2 - HDD Slot 5</b> | <b>5 - HDD Slot 6</b>  | <b>8 - HDD Slot 7</b>  | <b>11 - HDD Slot 8</b>  |
| <b>3 - HDD Slot 9</b> | <b>6 - HDD Slot 10</b> | <b>9 - HDD Slot 11</b> | <b>12 - HDD Slot 12</b> |

**Figure 8:** DXi6900 Drive Carrier

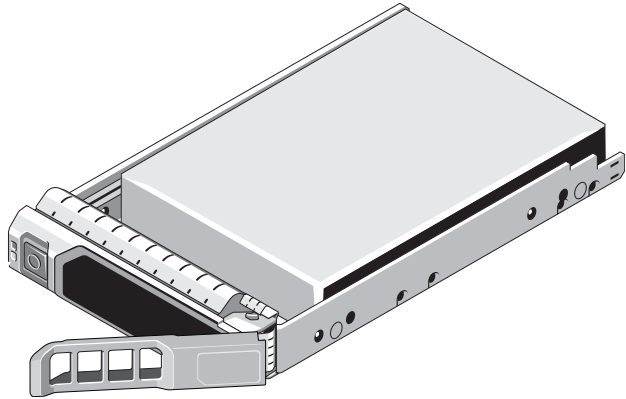

**Figure 9:** DXi6900 Hard Drive Carriers - Array and Expansion Modules

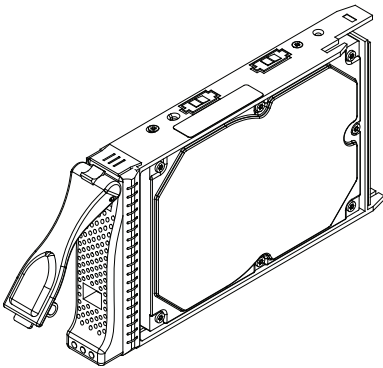

## SDDs

The DXi6900-S Node supports thirteen high capacity (800 GB) solid state drives (SDDs) (see [Figure 10 on the next page](#)). The Node hard drives are used for the operating system, system software, and indexes needed for data deduplication, replication, and space reclamation.

The DXi6900 Array modules (RBODs) and Expansion modules (EBODs) each support twelve high capacity (4 TB for DXi6900 G1/G2 and 8 TB for DXi6900-S) hard disk drives (see [HDDs on page 25](#)). The Array and Expansion module hard drives are used for data storage.

All solid state disk drives are mounted and pre-assembled in drive carriers (see [Figure 10 on the next page](#)). All drives are hot swappable.

**Figure 10:** DXi6900-S Node Drive Slot Numbering

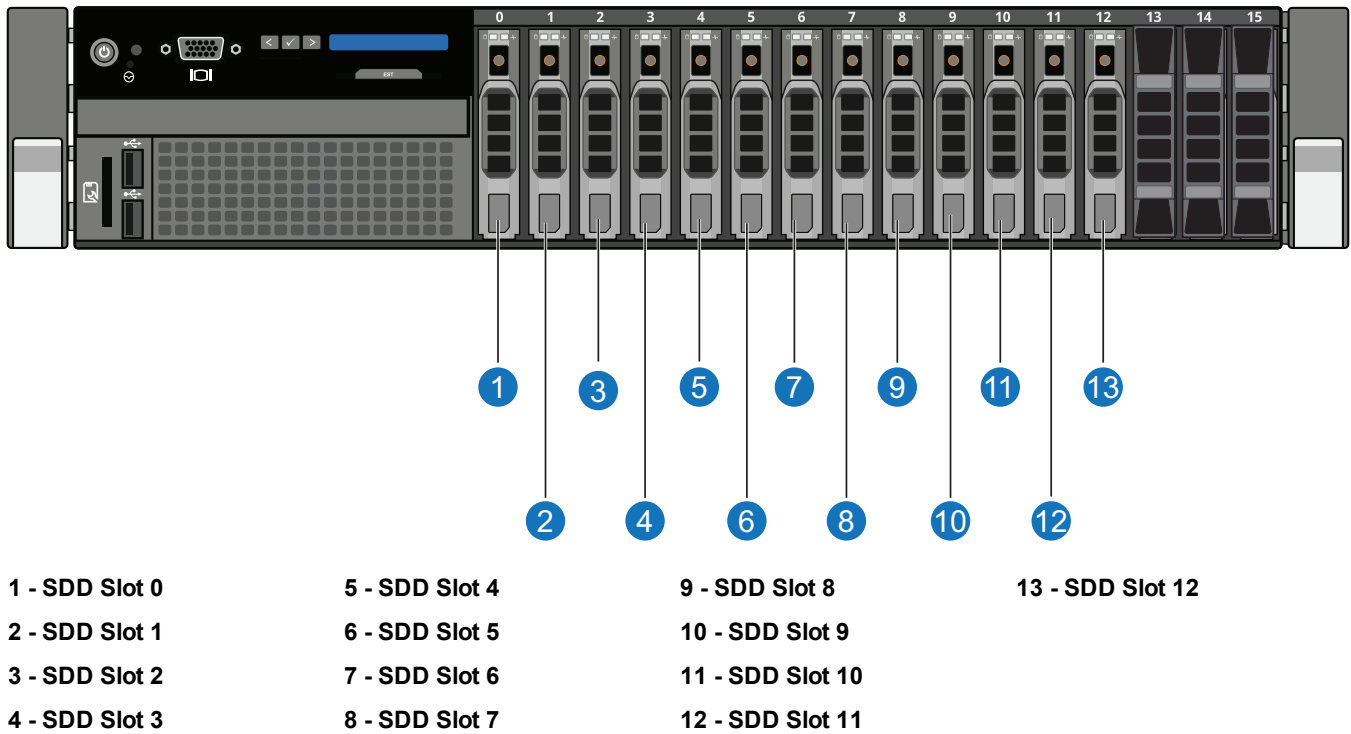

## Virtual Tape Storage

A virtual tape storage or virtual tape library (VTL) presentation allows the storage space on these hard drives to appear to the backup application as tape cartridges (DLT or LTO). Data is stored on the hard drives through an interface that appears as a tape library, with virtual cartridges, virtual drives, and a virtual changer mechanism. A DXi6900 can be configured to present multiple VTL interfaces of different sizes and types at once. This allows backup applications to recognize and integrate a DXi series system into a data center environment just like one or more physical tape libraries.

**Figure 11:** VTL Example

### VTL (Virtual Tape Library)

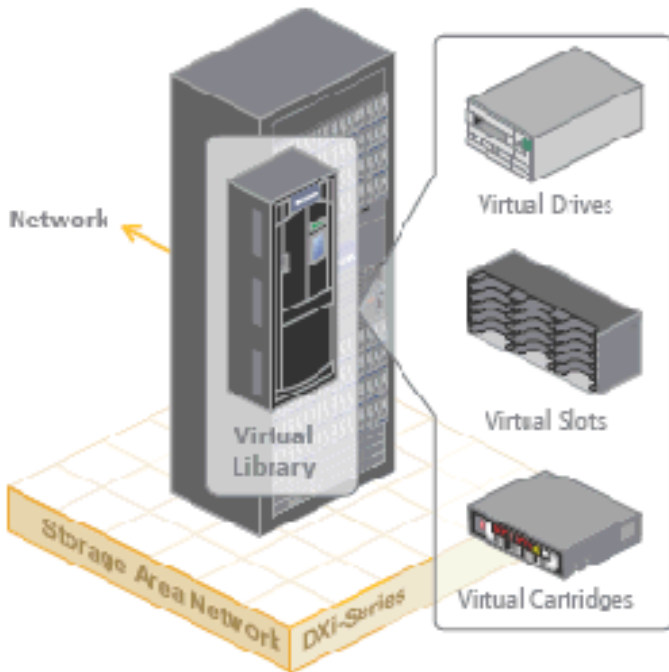

## Network Attached Storage (NAS)

The DXi6900 system has the ability to serve as a NAS backup system (see [Figure 12 on the next page](#)) where the following protocols are supported:

- [CIFS/SMB Protocol below](#)
- [NFS Protocol on the next page](#)
- [Application Specific Protocol \(DXi6900-S\) on the next page](#)

### CIFS/SMB Protocol

The CIFS (Common Internet File System) / SMB (Server Message Block) protocol defines a standard for remote file access from many computers at a time in Windows environments.

#### Active Directory Support

The DXi6900 supports ADS (Active Directory Services) as well as ACLs (Access Control Lists). This provides the following benefits:

- **Compatibility with CIFS/SMB domains** - NAS shares are able to join CIFS/SMB domains and use domain authentication.
- **Precise control of file system permissions** - Administrators can specify which users and groups can perform what actions.
- **Robust administrative support** - Administrators have the same implicit permissions as they do in Windows operating systems.

### Additional Information

- Windows 2003, Windows 2003 R2, Windows 2008, Windows 2008 R2, and Windows 2012 R2 are supported for Active Directory domain membership.
- When you create a CIFS/SMB share, the initial permissions are the same as the default permissions for a Windows 2003 share with the addition of an ACE (Access Control Entry) that permits full access to the share for all authenticated users. Administrators can choose to remove this full access ACE, set up custom permissions, or leave the ACL (Access Control List) as is if the server is set up in a fully trusted environment.

## NFS Protocol

The NFS (Network File System) protocol was originally designed by Sun™ Microsystems and allows all network users to access shared files stored on computers of different types. NFS provides access to shared files through an interface called the Virtual File System (VFS) that runs on top of TCP/IP. Users can manipulate shared files as if they were stored locally on the user's own hard disk. With NFS, computers connected to a network operate as clients while accessing remote files, and as servers while providing remote users access to local shared files. This protocol is used with UNIX and Linux networks. It can also be used with Windows networks.

**Figure 12:** NAS Backup using CIFS/SMB and NFS



## Application Specific Protocol (DXi6900-S)

The Application Specific Protocol allows users to create Oracle Recovery Manager (RMAN) shares on a DXi6900-S system. RMAN provides the foundation for efficiently backing up and recovering an Oracle database.

## OpenStorage (OST)

With the OST presentation, the DXi system presents storage servers to a Symantec NetBackup or Backup Exec media server through a specific Symantec protocol. A storage server consists of logical storage units (LSUs), which are similar to directories in a NAS file system or tape cartridges in a VTL partition.

The OST presentation requires the Symantec NetBackup (7.1.x or later) or Backup Exec 2010 R3 or later host application and the OST Plug-in client installation on the media server.

**Note:** Windows 2012 64-bit requires Symantec NetBackup (7.6 or later) or Backup Exec 2014 or later.

Plug-in clients are host-OS dependent and are supplied by Quantum. To use the DXi in OST mode, you must configure an OST storage server and LSUs on the DXi. You must also map the LSUs on the NetBackup server so that NetBackup can perform backups and restore from them. Additionally, policies for optimized duplication (OST replication) and OST direct to tape may need to be set on the NetBackup server.

**Figure 13:** OpenStorage (OST) Example

### OST (Open Storage)

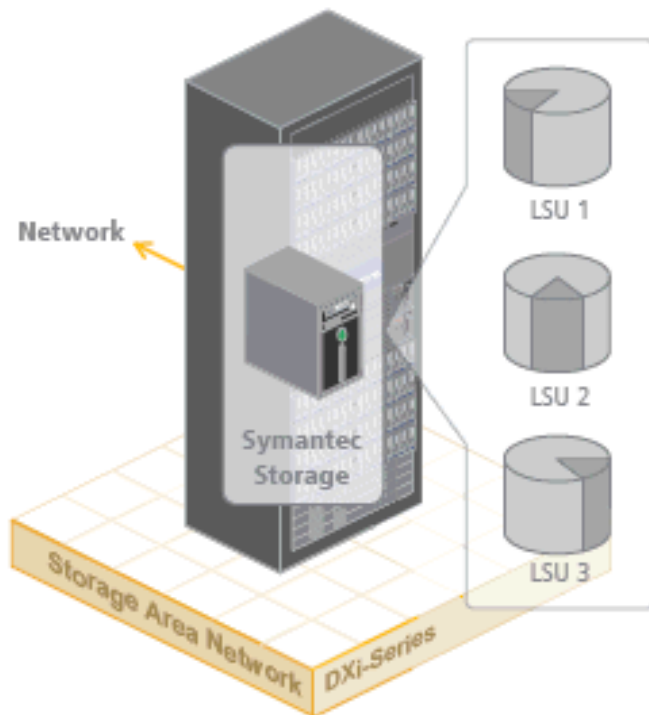

# Supported RAID Configurations

RAID is short for Redundant Array of Independent (or Inexpensive) Disks, which is a category of storage that employs two or more drives in combination for fault tolerance and performance.

DXi6900 G1 and G2 systems use the following RAID levels:

- [RAID 1 Configuration below](#)
- [Dynamic Disk Pool \(DDP\) Technology on page 34](#)

DXi6900-S systems use the following RAID levels:

- [RAID 6 Configuration on the next page](#)
- [Dynamic Disk Pool \(DDP\) Technology on page 34](#)

## RAID 1 Configuration

RAID 1 provides redundancy and fault tolerance by mirroring disks. Each disk in the RAID set contains a copy of the same data. For example, in a RAID set with two disks, if one disk fails, all of the data still exists on the other disk.

The DXi6900 G1 and G2 Nodes use RAID 1 sets for the boot disk (operating system) as well as for the blockpool index.

The Node contains the following RAID 1 sets (see [Figure 14 on the next page](#)):

- **BOOT** - HDD slots 1 and 8 (operating system and journal files)
- **META 1** - HDD slots 2 and 9 (blockpool index)
- **META 2** - HDD slots 3 and 10 (blockpool index)
- **META 3** - HDD slots 4 and 11 (blockpool index)
- **META 4** - HDD slots 5 and 12 (blockpool index)
- **META 5** - HDD slots 6 and 13 (blockpool index)
- **META 6** - HDD slots 7 and 14 (blockpool index)

---

**i Note:** Node HDD slots 0 and 15 contain global hot spares.



**Figure 14:** DXi6900 Node RAID Sets

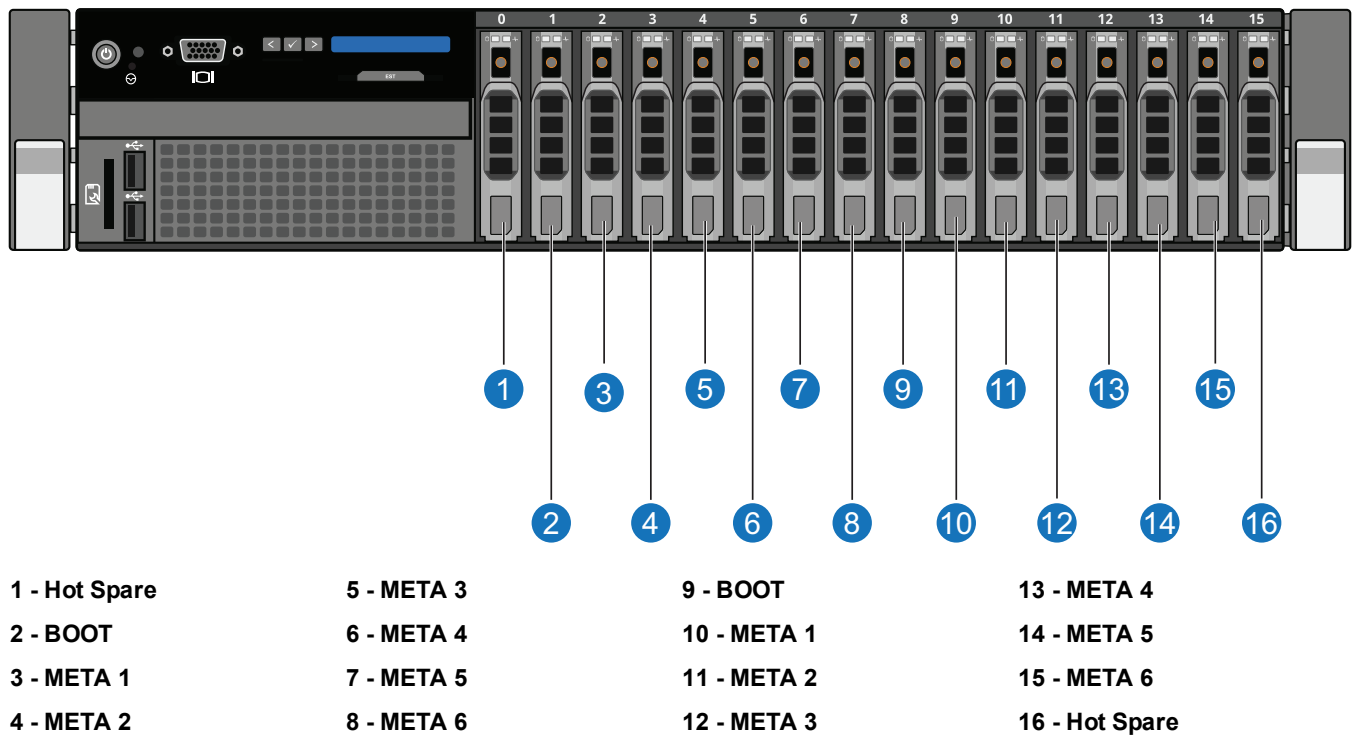

## RAID 6 Configuration

RAID 6 uses block-level striping with two parity blocks distributed across all member disks. Dual parity provided by a RAID 6 configuration ensures that your data retains full integrity even in the event of two hard drive failures. .

The DXi6900-S uses RAID 6 volumes for data storage (see [Figure 15 on the next page](#)).

**Figure 15:** DXi6900-S Node RAID Sets

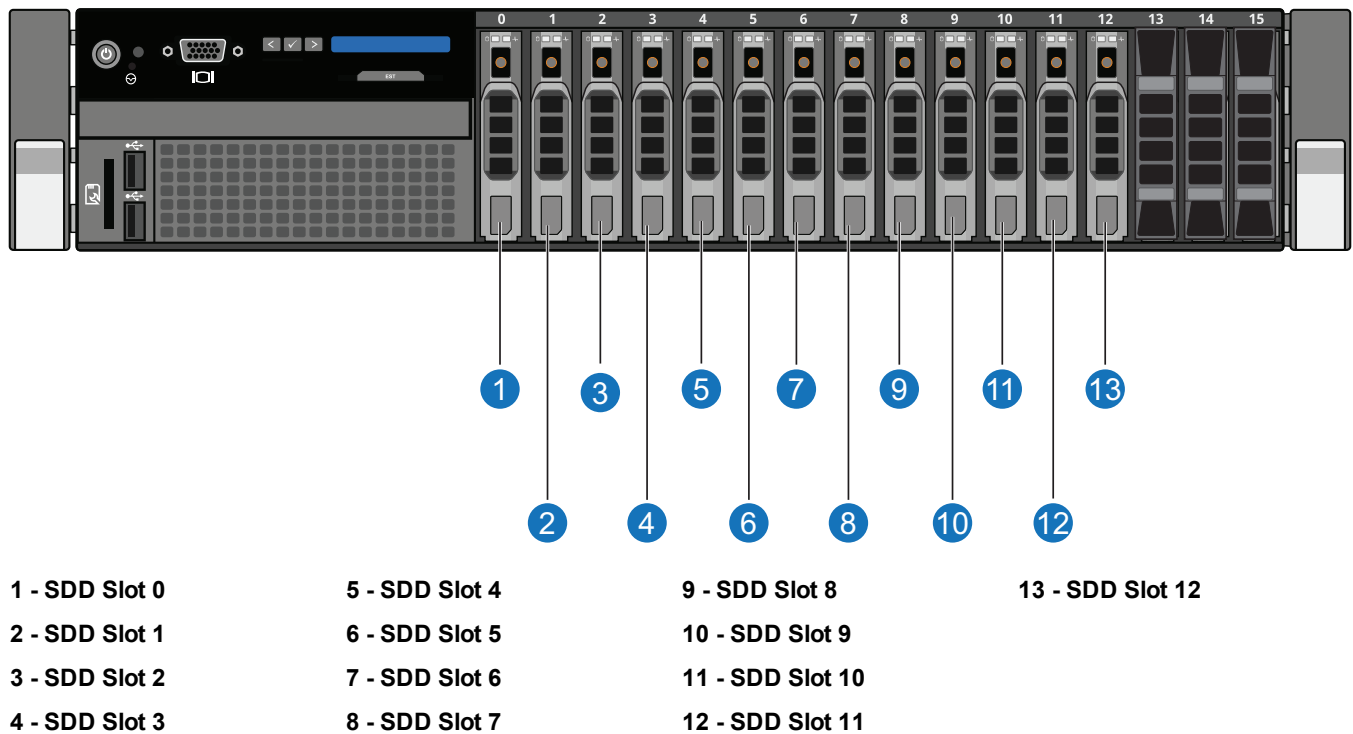

## Dynamic Disk Pool (DDP) Technology

Dynamic Disk Pool (DDP) technology is a new alternative to traditional RAID configuration. DDP distributes data, parity information, and spare capacity across a pool of drives, providing the following benefits:

- Faster drive recovery
- Easier storage expansion
- Dynamic re-balancing of data across drives
- Better data availability

The DXi6900 Array modules (RBODs) and Expansion modules (EBODs) use Dynamic Disk Pool technology for data storage (see [Figure 16 on the next page](#)). All hard disk drives in an Array or Expansion module are configured in a single DDP pool.

The Dynamic Disk Pool does not include a physical hot spare. However, enough disk space is reserved to provide the equivalent of a hot spare. And similar to RAID 6, a DDP pool can tolerate up to two drive faults.

**Figure 16:** DXi6900 Array and Expansion Module DDP Pools

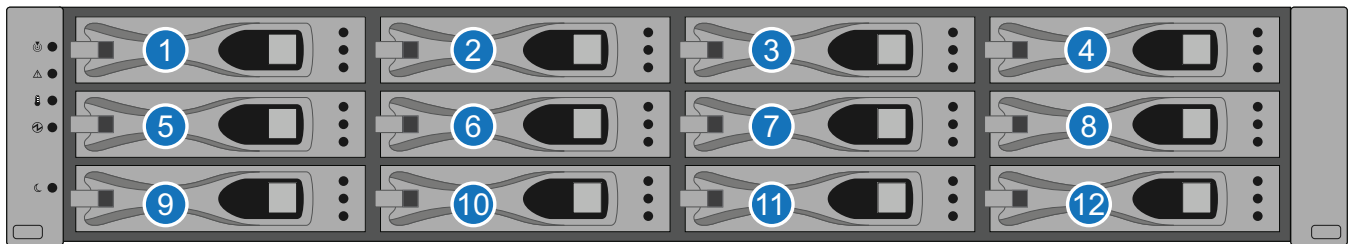

- |              |              |              |               |
|--------------|--------------|--------------|---------------|
| 1 - DDP Pool | 4 - DDP Pool | 7 - DDP Pool | 10 - DDP Pool |
| 2 - DDP Pool | 5 - DDP Pool | 8 - DDP Pool | 11 - DDP Pool |
| 3 - DDP Pool | 6 - DDP Pool | 9 - DDP Pool | 12 - DDP Pool |

---

## DXi Advanced Reporting

Quantum DXi Advanced Reporting works with all DXi-Series disk backup systems. DXi Advanced Reporting combines comprehensive performance data logging with powerful visual reporting and analysis tools to help you identify potential problems and optimize system operation. For more information, refer to the *DXi Advanced Reporting User's Guide* (6-67353).

---

## Network Configuration

During network configuration, each individual interface on the DXi6900 can be configured as a subnet with its own network settings. Each physical Ethernet port can be configured as an interface. In addition, you can also create bonded interfaces (logical ports) consisting of two or more physical ports.

Keep in mind that any traffic can pass through any of the configured Ethernet ports. This means that the routing of different traffic types, as well as firewall capability, must be controlled using the network infrastructure (routers and switches) connected to the DXi6900.

For more information about configuration network settings, see [Network on page 322](#).

**Note:** Each configured network interface requires its own set of network settings (IP address, network mask, and gateway).

**Caution:** For effective bonded network use, a properly configured network switch is required. (A network switch is not supplied with the DXi6900.) The DXi6900 bonding settings must match the switch settings. If the switch settings and the DXi6900 settings do not match, your system may become inaccessible through the switch.

# Best Practices

There are several items that should be considered when installing and configuring your DXi6900 system. By reviewing this information, you can help shorten the installation and configuration time for your system.

- [Licensing below](#)
- [Virtual Media—How Many and What Size? on page 39](#)

## Licensing

The features of the DXi6900 are enabled through licensing options, which are available through the remote management console (see [License Keys on page 377](#)).

Licenses are either factory-installed on the DXi6900, or they are available through a license certificate, which is included with the system.

## Factory-Installed Licenses

The following DXi6900 licenses are factory-installed:

- [NAS below](#)
- [VTL below](#)
- [Backup Application Specific \(Path to Tape\) below](#)
- [Data Deduplication on page 38](#)
- [Replication on page 39](#)
- [Storage Capacity on page 39](#)
- [OST on page 39](#)
- [Data-in-Flight Encryption on page 39](#)

### NAS

The *Network Attached Storage (NAS)* license allows NAS shares to be exposed to backup hosts and applications. (License key is pre-installed on all DXi6900 systems.)

### VTL

The *Virtual Tape Library (VTL)* license allows virtual devices such as the media changer and tape drive to be exposed to the attached Fibre Channel hosts. (License key for 160 VTDs is pre-installed on all DXi6900 systems.)

### Backup Application Specific (Path to Tape)

The *Backup Application Specific* license allows you to export virtual media directly to a maximum of 3 concurrent path-to-tape physical tape drives using Backup Application Specific NDMP or OST Direct to Tape. (License key is pre-installed on all DXi6900 systems.)

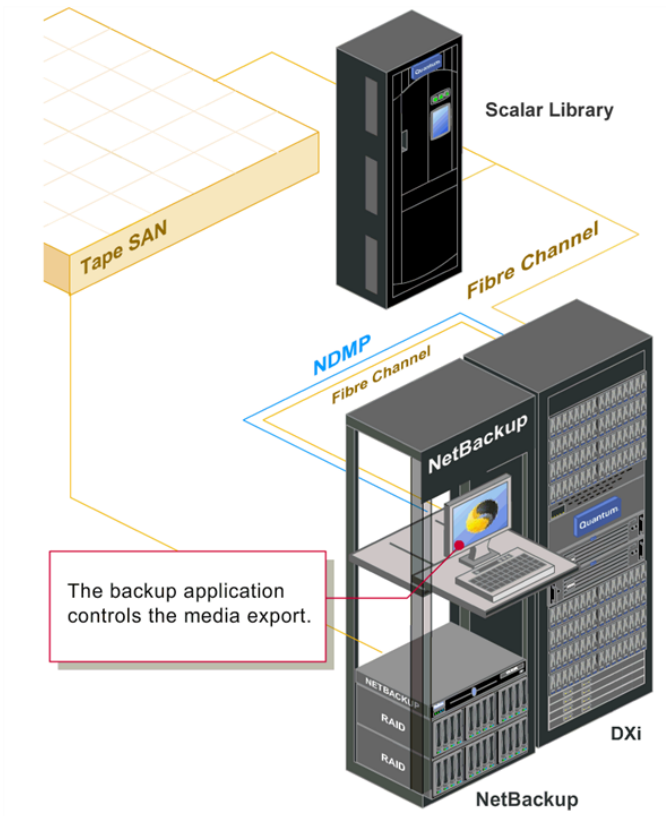

The Backup Application Specific option works with the following backup applications:

- Symantec NetBackup 7.1.x and higher — direct-to-tape feature
- Symantec Backup Exec 2010 R3 and higher
- EMC Networker

---

**i Note:** EMC NetWorker 8.1 and later do not support Backup Application Specific Path to Tape.

- Oracle Secure Backup 10.3
- ASG-Time Navigator

---

**i Note:** For more information, see the *DXi-Series Backup Application Specific Path to Tape Configuration Guide* (6-67211).

When the Path to Tape feature is enabled and configured, backup data can be moved directly from the DXi6900 system to a tape library. For a list of supported tape libraries and tape drives for Backup Application Specific, see [Table 1 on the next page](#) and [Table 2 on the next page](#).

**Table 1:** Supported Tape Libraries in Backup Application Specific

Vendor	Tape Library
Quantum	Scalar i40 and i80
	Scalar i500
	Scalar i2000 and i6000
	Scalar 24
	Scalar 50 (PX502)
	PX500
	PX720
Dell	PV132T
	PVT136T
	ML6000
HP	ESL E Series
	EML Series
IBM	TS3500
Oracle/STK	L180 (FC only)
	L700 (FC only)
	SL500 (FC only)
	SL3000 (FC only)

**Table 2:** Supported Tape Drives in Backup Application Specific

Vendor	Tape Drive
Quantum	SDLT320, SDLT600, DLT-S4, LTO-2, and LTO-3
HP	LTO-2, LTO-3, LTO-4, LTO-5, and LTO-6
IBM	LTO-2, LTO-3, LTO-4, LTO-5, and LTO-6

### Data Deduplication

The *Data Deduplication* license allows the DXi6900 to reduce the size of data stored on the system through the deduplication process (see [Data Reduction](#)). (License key is pre-installed on all DXi6900 systems.)

## Replication

The *Replication* license allows the DXi6900 to replicate data to up to two target systems and received replicated data from up to ten source systems. (License key is pre-installed on all DXi6900 systems.)

## Storage Capacity

The *Storage Capacity* license is factory-installed for the installed capacity. Additional capacity requires a certificate license that comes with each Expansion module. This license allows the storage capacity of the DXi6900 to be increased. (License key is pre-installed on all DXi6900 systems.)

## OST

The *OST* license, when enabled, allows a Open Storage Technology (OST) connection. For Symantec users with specific versions of the software, another replication option is available for DXi6900 models through the Symantec OpenStorage (OST) API. (License Certificate is included with all DXi6900 systems.)

---

**i Note:** For more information, see the *DXi-Series NetBackup and Backup Exec OST Configuration Guide* (6-67079).

## Data-in-Flight Encryption

The *Data-in-Flight Encryption* license enables use of AES encryption (128-bit or 256-bit) when replicating data to another system. (Not available in all regions.)

---

**i Note:** *Data-in-Flight Encryption* licenses for the DXi6900-S are not factory installed and available through a license certificate only.

# Virtual Media—How Many and What Size?

There is no correct answer to this question as it really depends on your backup regime and the backup application in use. A DXi system does not preallocate disk space when a virtual tape cartridge is created, there can be an inclination to create a lot of large virtual tape cartridges, greater than the amount that is actually required. While this has no initial bearing on the DXi's capacity utilization, it can cause issues down the track.

Regarding the quantity of virtual media you need to create, as long as there is sufficient media to hold the amount of backup data for the required retention period, the quantity does not really matter. However, it is extremely important, as mentioned earlier, that the aging and expiry rules of the media pool are defined early. If these rules are not defined, the virtual tape cartridges will never enter the scratch pool resulting in you running out of virtual media, and in turn space on the DXi system. As a rule of thumb, more is better than less; as long as expiry rules are defined.

Although there is no perfect size when it comes to creating virtual tape cartridges, there are a few factors to consider. If a virtual tape cartridge is created at 200 GB, then it will be presented as storing 200 GB of native data.

Creating smaller sized media is preferred, for example 50 GB or 100 GB, as it allows a virtual tape cartridge to be completely filled even when backing up smaller data sets. Smaller sized media also aids the transfer of data from virtual to physical tape platforms. Once again, virtual tape cartridge size will depend on the backup application in use.

It is important to note that the design of the DXi will not allow a virtual tape cartridge to be written to if its size is larger than the amount of free space available on the DXi. For example, if you have a virtual tape cartridge size of 400 GB but only 300 GB of free space is available on the DXi, the backup will fail when attempting to write data to the virtual tape cartridge. As a result, smaller virtual tape cartridge sizes are better.

Remember, the DXi system is always cautious of being filled up so that the integrity of stored data is not compromised.





## Chapter 2: Basic Operations

---

This chapter describes the hardware features and basic operation of DXi6900 systems and includes the following sections:

DXi6900 Node .....	41
DXi6900 Array and Expansion Modules .....	54
Turning On and Shutting Down the DXi6900 .....	60
Locating DXi6900 Serial Numbers .....	62

---

### DXi6900 Node

The DXi6900 Node is a computer server that provides control for the DXi software (host OS and software applications). The Node also stores support data for the DXi6900 system, such as metadata and indexes. The DXi6900 G1 and G2 Nodes contain 16 drive carriers. The DXi6900-S Node contains 13 drive carriers. In addition, all network connections are made on the Node.

All DXi6900 systems include one Node.

The DXi6900 Node has a series of LED indicators and buttons located on the front and back of each component:

- [DXi6900 Node Front Panel Features and Indicators on the next page](#)
- [DXi6900 Node Rear Panel Features on page 45](#)
- [Node Drive Carrier Indicators on page 50](#)

- [DXi6900 Node 1 GbE Ethernet on page 51](#)
- [DXi6900 Node 10 GbE Ethernet Port Indicators on page 52](#)
- [DXi6900 Node 10 GBase-T Ethernet Port Indicators on page 52](#)
- [DXi6900 Node Power Supply Indicators on page 53](#)

## DXi6900 Node Front Panel Features and Indicators

[Figure 17 below](#) and [Figure 18 on the next page](#) shows the controls, indicators, and connectors located behind the optional rack bezel on the front panel of the Node. [Table 1 on the next page](#) describes each item.

**Figure 17:** DXi6900 Node Front View

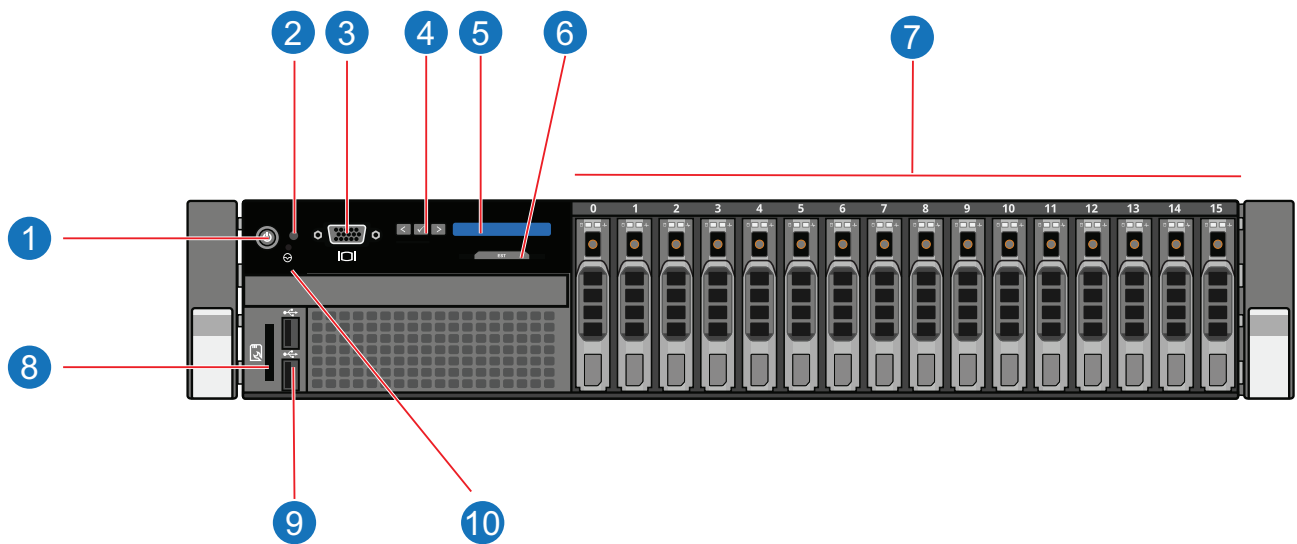



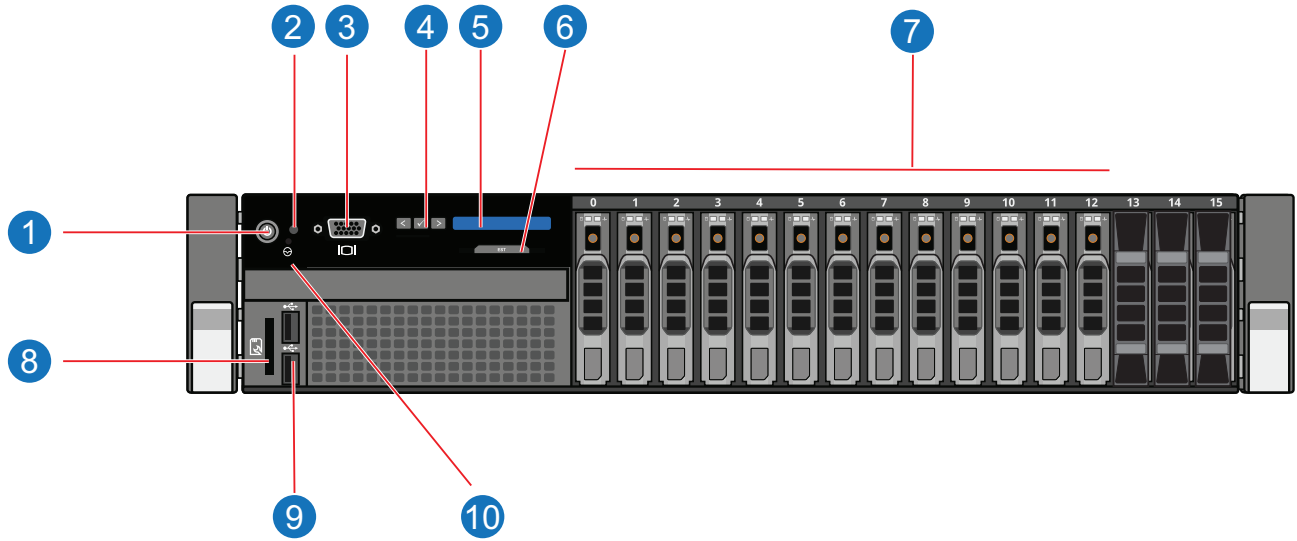

**Figure 18:** DXi6900-S Node Front View



**Table 1:** DXi6900 Node - Front Panel LED Indicators, Buttons, and Connectors

Item	Indicator, Button, or Connector	Icon	Description
1	Power-on indicator, power button.		<p>The power-on indicator lights when the system power is on. The power button controls the power supply output to the system.</p> <p><b>WARNING:</b> Turning off the power removes the main power but keeps standby power supplied to the Node. Because of this, you must unplug the Node before servicing.</p> <p><b>Caution:</b> Turning off the power without properly shutting down the system may result in loss of data (see <a href="#">Turning On and Shutting Down the DXi6900 on page 60</a>).</p> <p><b>Note:</b> To shut down the Node in the event of an emergency, press and hold the power button for 4 seconds. <b>Warning:</b> This may result in data loss and may cause a delay on next startup due to a blockpool verify operation.</p>
2	System identification button		<p>Press to toggle the system ID on and off. The identification buttons on the front and rear panels can be used to locate a particular system within a rack. When one of these buttons is pressed, the system status indicator on the rear flashes until one of the buttons is pressed again.</p>

Item	Indicator, Button, or Connector	Icon	Description
3	Video connector		Allows you to connect a VGA display to the system. For service use only.
4	LCD menu buttons		Not used.
5	LCD panel		Lights blue during normal system operation
6	Information tag		A slide-out label panel which displays the system serial number.
7	Drives		Sixteen 2.5 inch hot-swappable hard drives (DXi6900 G1/G2). Thirteen 2.5 inch hot-swappable solid state drives (DXi6900-S).
8	vFlash media card slot		Not used.
9	USB 2.0 connector (2)		Allows you to connect USB devices to the system. The ports are USB 2.0-compliant. <b>⚠ Caution:</b> Use of connected peripheral devices, such as a USB keyboard and mouse or a VGA display, is not supported and may cause incorrect system operation.
10	NMI buttons		Not used.

## DXi6900 Node Rear Panel Features

[Figure 19 on the next page](#) shows the connectors located on the rear panel of the DXi6900 G1 Node. [Table 1 on the next page](#) describes each item. [Table 2 on page 47](#) describes the PCI slot configuration options.

[Figure 20 on page 48](#) shows the connectors located on the rear panel of the DXi6900 G2 and DXi6900-S Nodes. [Table 3 on page 48](#) describes each item. [Table 4 on page 49](#) describes the PCI slot configuration options.

---

**i Note:** Refer to the port numbering labels on the back of the Node chassis to help you determine the correct port connections.

---

**! Caution:** Do not disconnect any SAS cables from the Node during normal system operation. Unplugging a SAS cable while the system is powered on may result in data loss.

### 10 GbE Cable Types

Depending on the configuration, Quantum DXi6900 systems support one of the following 10 GbE cable types:

- **10 GbE optical cable lengths of up to 300 meters with OM3 cables and up to 100 meters with OM2 cables** - Quantum recommends using the two 10 meter LC to LC type optical cables that are shipped with the DXi6900 system. Consult your 10 GbE optical switch/SFP documentation for additional information on optical cable requirements.
- **10 GbE Twinax cable** - Quantum recommends using the approved 5 meter Twinax cable type that is shipped with the DXi6900 system. This cable is compatible with Cisco 5000 Series Data Center Class switches.





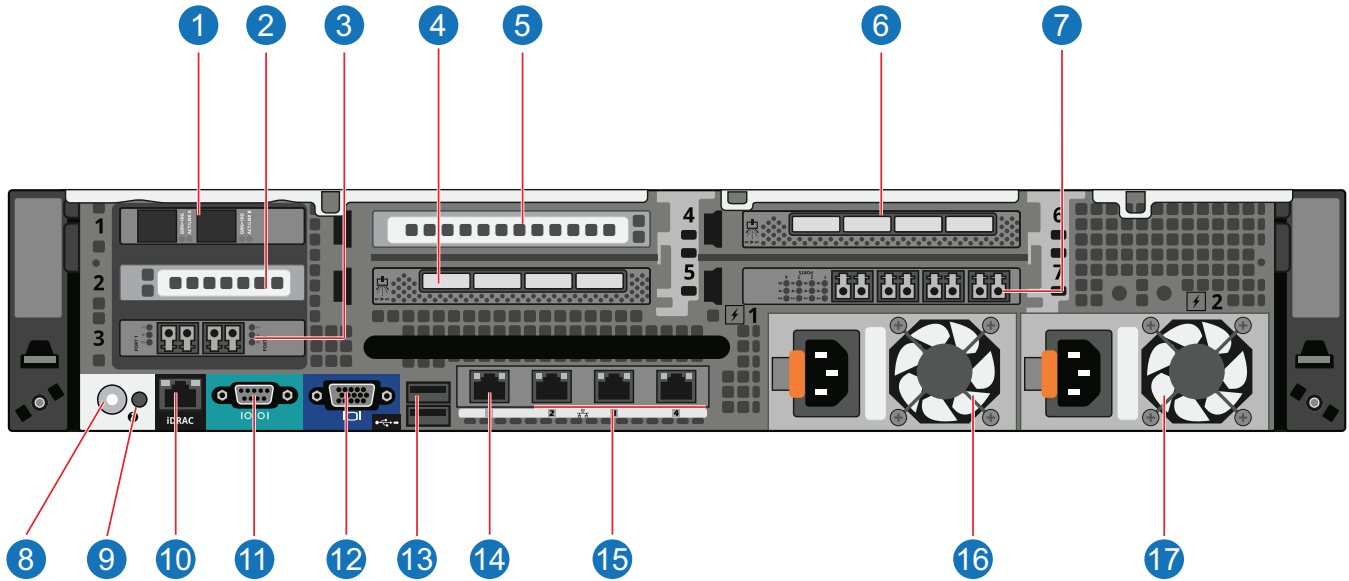

The 10 GbE Copper (Twinax) cable options that Quantum provides do not support all switches. Please note the supported switches during the purchase-configuration process, and if the Twinax cables supplied by Quantum are not compatible with your switch, then you will need to provide your own compatible Twinax cables from your switch vendor. Be sure to have these available before the system installation takes place.

**Figure 19:** Node Rear View - DXi6900 G1



**Table 1:** Rear Panel Connectors - DXi6900 G1

Item	Indicator, Button, or Connector	Icon	Description
1	2 x 10 GbE (SFP+) Ethernet ports		For data ingest/read.
2	(Optional) 2 x 10 GbE (SFP+) Ethernet ports or 4 x 1 GbE Ethernet ports		For data ingest/read. <a href="#">Table 2 on the next page</a> lists all DXi6900 G1 configuration options.
3	2 x 8 Gb or 2 x 16 Gb Fibre Channel ports		For path to tape or VTL ingest/read.
4	4 x 6 Gb SAS ports		For connection to Array modules (RBOD)s. <b>Note:</b> The rightmost two ports are not used.
5	(Optional) 2 x 10 GbE Ethernet port		For data ingest/read. <a href="#">Table 2 on the next page</a> lists all DXi6900 G1 configuration options.
6	4 x 6 Gb SAS ports		For connection to Array modules (RBOD)s. <b>Note:</b> The rightmost two ports are not used.
7	4 x 8 Gb or 2 x 16 Gb Fibre Channel ports		For path to tape or VTL ingest/read.

Item	Indicator, Button, or Connector	Icon	Description
8	System identification button		Press to toggle the system ID on and off. The identification buttons on the front and back panels can be used to locate a particular system within a rack. When one of these buttons is pressed, the LCD panel on the front and the system status indicator on the back flashes until one of the buttons is pressed again.
9	System identification connector		Not used.
10	iDRAC port		For Quantum use only.
11	Serial connector		For Quantum use only.
12	VGA connector		<b>⚠ Caution:</b> Use of connected peripheral devices, such as a USB or PS/2 keyboard and mouse or a VGA display, is not supported and may cause incorrect system operation.
13	USB 2.0 connectors (2)		<b>⚠ Caution:</b> Use of connected peripheral devices, such as a USB or PS/2 keyboard and mouse or a VGA display, is not supported and may cause incorrect system operation.
14	Service port		For Quantum use only.
15	3 x 1 GbE Ethernet ports		For data ingest/read.
16	Power supply (PSU1)		750 watt hot-swappable power supply.
17	Power supply (PSU2)		750 watt hot-swappable power supply.

**Table 2:** DXi6900 G1 PCI Slot Configuration Options

Option	PCI Slot 2	PCI Slot 4
101	2 x 10 GbE (SFP+) Ethernet ports	
102	4 x 1 GbE Ethernet ports	
103		2 x 10 GBase-T Ethernet port



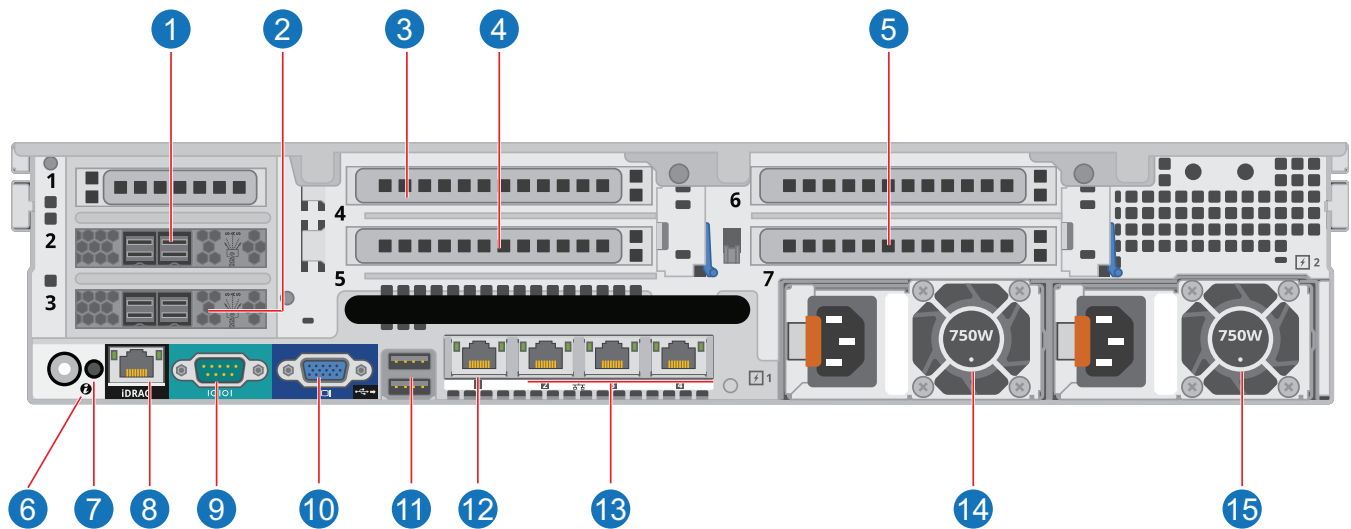





**Figure 20:** Node Rear View - DXi6900 G2 and DXi6900-S



**Table 3:** Rear Panel Connectors - DXi6900 G2 and DXi6900-S

Item	Indicator, Button, or Connector	Icon	Description
1	2 x 12 Gb SAS ports		For connection to Array modules (RBOD)s.
2	2 x 12 Gb SAS ports		For connection to Array modules (RBOD)s.
3	(Optional) 2 x 10 GbE (SFP+) Ethernet ports 2 x 10 GBase-T Ethernet port 2 x 16 Gb Fibre Channel		For data ingest/read (Ethernet) or path to tape/VTL ingest/read (Fibre Channel). <a href="#">Table 4 on the next page</a> lists all DXi6900 G2 and DXi6900-S configuration options.
4	(Optional) 2 x 10 GbE (SFP+) Ethernet ports 2 x 10 GBase-T Ethernet port 2 x 16 Gb Fibre Channel		For data ingest/read (Ethernet) or path to tape/VTL ingest/read (Fibre Channel). <a href="#">Table 4 on the next page</a> lists all DXi6900 G2 and DXi6900-S configuration options.
5	(Optional) 2 x 10 GbE (SFP+) Ethernet ports 2 x 10 GBase-T Ethernet port 2 x 16 Gb Fibre Channel		For data ingest/read (Ethernet) or path to tape/VTL ingest/read (Fibre Channel). <a href="#">Table 4 on the next page</a> lists all DXi6900 G2 and DXi6900-S configuration options.



Item	Indicator, Button, or Connector	Icon	Description
6	System identification button		Press to toggle the system ID on and off. The identification buttons on the front and back panels can be used to locate a particular system within a rack. When one of these buttons is pressed, the LCD panel on the front and the system status indicator on the back flashes until one of the buttons is pressed again.
7	System identification connector		Not used.
8	iDRAC port		For Quantum use only.
9	Serial connector		For Quantum use only.
10	VGA connector		 <b>Caution:</b> Use of connected peripheral devices, such as a USB or PS/2 keyboard and mouse or a VGA display, is not supported and may cause incorrect system operation.
11	USB 2.0 connectors (2)		 <b>Caution:</b> Use of connected peripheral devices, such as a USB or PS/2 keyboard and mouse or a VGA display, is not supported and may cause incorrect system operation.
12	Service port		For Quantum use only.
13	3 x 1 GbE Ethernet ports		For data ingest/read.
14	Power supply (PSU1)		750 watt hot-swappable power supply.
15	Power supply (PSU2)		750 watt hot-swappable power supply.

**Table 4:** DXi6900 G2 and DXi6900-S PCI Slot Configuration Options

 **Caution:** The PCI slot location for each card must be followed in each configuration option.

PCI Slot 4	PCI Slot 5	PCI Slot 7
	2 x 16 Gb Fibre Channel	

PCI Slot 4	PCI Slot 5	PCI Slot 7
	2 x 16 Gb Fibre Channel	2 x 16 Gb Fibre Channel
2 x 16 Gb Fibre Channel	2 x 16 Gb Fibre Channel	2 x 16 Gb Fibre Channel
2 x 10 Gb Ethernet *		
2 x 10 Gb Ethernet *		2 x 10 Gb Ethernet *
2 x 10 Gb Ethernet *	2 x 10 Gb Ethernet *	2 x 10 Gb Ethernet *
2 x 10 Gb Ethernet *	2 x 16 Gb Fibre Channel	
2 x 10 Gb Ethernet *	2 x 16 Gb Fibre Channel	2 x 16 Gb Fibre Channel
2 x 10 Gb Ethernet *	2 x 16 Gb Fibre Channel	2 x 10 Gb Ethernet *

\* 2 x 10 Gb Ethernet = 2 x 10 GbE (SFP+) or 2 x 10 GBase-T Ethernet ports

## Node Drive Carrier Indicators

Each DXi6900 hard drive carrier in the Node module has two LED indicators (see [Figure 21 on the next page](#)):

LED Indicator	Activity
<b>Drive activity indicator (green)</b>	<ul style="list-style-type: none"> <li>• <b>Flashing</b> - Indicates hard disk drive activity.</li> </ul>
<b>Drive status indicator (green and amber)</b>	<ul style="list-style-type: none"> <li>• <b>Off</b> - Drive ready for insertion or removal <ul style="list-style-type: none"> <li>• <b>Note:</b> The drive status indicator remains off until all drives are initialized after system power is applied. Drives are not ready for insertion or removal during this time.</li> </ul> </li> <li>• <b>Blinks green two times per second</b> - Identify drive/preparing for removal</li> <li>• <b>Blinks green, amber, and off</b> - Drive predicted failure</li> <li>• <b>Blinks amber four times per second</b> - Drive failed</li> <li>• <b>Blinks green slowly</b> - Drive rebuilding</li> <li>• <b>Steady green</b> - Drive online</li> <li>• <b>Blinks green three seconds, amber three seconds, and off six seconds</b> - Rebuild aborted</li> </ul>

---

**i Note:** If a drive fails, you will be notified by a service ticket in the remote management console (see [Service Tickets on page 207](#)).

**! Caution:** Do *not* remove a drive that has *not* failed. Instead, only remove a drive that has failed. If you accidentally remove a good drive, wait 30 seconds before reinserting the drive.

**Figure 21:** DXi6900 Hard Drive Carrier LEDs



**1 - Drive activity indicator (green) 2 - Drive status indicator (green and amber)**

## DXi6900 Node 1 GbE Ethernet

Each 1 GbE Ethernet port on the DXi6900 Node rear panel has two LED indicators (see [Figure 22 below](#)):

---

**Link indicator**

- **Off** - Indicates the port is not connected to the network.
- **Green** - Indicates the port is connected to the network at maximum speed (1Gbps).
- **Amber** - Indicates the port is connected to the network at less than its maximum port speed.

---

**Activity Indicator**

**Blinking green** - Indicates network data is being sent or received.

---

**Figure 22:** DXi6900 Node - 1 GbE Ethernet Port LEDs

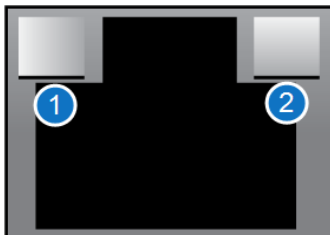

**1 - Link Indicator 2 - Activity Indicator**

## DXi6900 Node 10 GbE Ethernet Port Indicators

Depending on the configuration, Quantum DXi6900 systems include a 10 GbE adapter card (dual optical or Twinax ports).

The 10 GbE adapter with dual optical or Twinax ports has two LED indicators for each 10 GbE port (see [Figure 23 below](#)):

---

<b>Link indicator</b>	<ul style="list-style-type: none"><li>• <b>Off</b> - Indicates the port is not connected to the network.</li><li>• <b>Green</b> - Indicates the port is connected to the network at 10Gbps speed.</li><li>• <b>Yellow</b> - Indicates the port is connected to the network at 1 Gbps speed.</li></ul>
<b>Activity Indicator</b>	<ul style="list-style-type: none"><li>• <b>Blinking</b> - Indicates network data is being sent or received.</li></ul>

---

**Figure 23:** DXi6900 - Optional 10 GbE Port LEDs (Optical or Twinax)

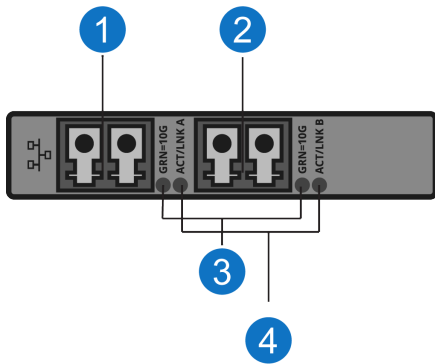

Item	Description
1	Port 1
2	Port 2
3	Link indicators
4	Activity Indicators

---

## DXi6900 Node 10 GBase-T Ethernet Port Indicators

Each 10 GBase-T port on the DXi6900 Node rear panel has two LED indicators (see [Figure 24 on the next page](#)):

---

<b>Link indicator</b>	<ul style="list-style-type: none"><li>• <b>Off</b> - Indicates the port is not connected to the network.</li><li>• <b>Green</b> - Indicates the port is connected to the network at maximum speed (10 Gbps).</li><li>• <b>Amber</b> - Indicates the port is connected to the network at less than its maximum port speed.</li></ul>
<b>Activity Indicator</b>	<ul style="list-style-type: none"><li>• <b>Blinking green</b> - Indicates network data is being sent or received.</li></ul>

---

**Figure 24:** DXi6900 - 10 GBase-T Ethernet Port LEDs



**1 - Activity Indicator    2 - Link Indicator**

## DXi6900 Node Power Supply Indicators

Each DXi6900 Node power supply has an illuminated translucent handle that serves as an indicator to show whether power is present or whether a power fault has occurred (see [Figure 25 on the next page](#)):

---

<b>Not lit</b>	Indicates power is not connected.
<b>Green</b>	Indicates a valid power source is connected to the power supply and that the power supply is operational.
<b>Flashing amber</b>	Indicates a problem with the power supply.
<b>Flashing green</b>	When hot-adding a power supply, this indicates that the power supply is mismatched with the other power supply. Replace the power supply that has the flashing indicator with a power supply that matches the capacity of the other installed power supply.

---

All power supplies are hot swappable. When replacing power supplies, never remove more than one power supply at a time from the system. Also, before you remove one power supply, make sure the other power supply is operating correctly (indicator handle is green).

**Figure 25:** DXi6900 Node - Power Supply LED

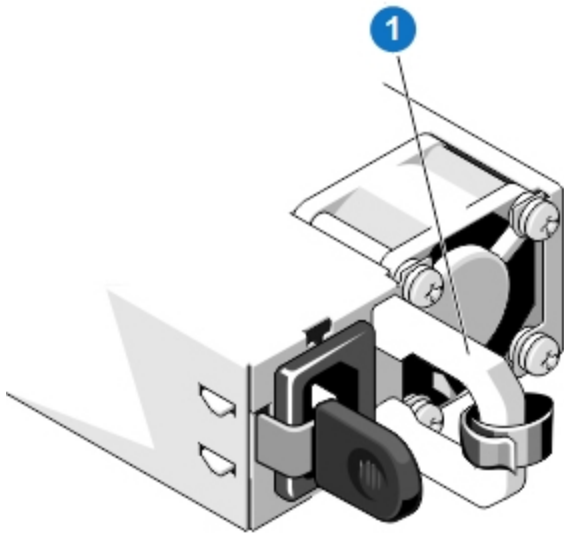

**1 - Power supply status indicator and handle**

---

## DXi6900 Array and Expansion Modules

The DXi6900 Array modules (RBODs) and Expansion modules (EBODs) are used to provide additional capacity (backup data storage) for the DXi6900 system. Each DXi6900 G1/G2 Array or Expansion module contains 12 drive carriers and provides 34 TB of licensable storage. Each DXi6900-S Array or Expansion module contains 12 drive carriers and provides 68 TB of licensable storage.

The DXi6900 can include 1 or 2 Array modules (RBODs). Array modules connect to the Node and contain dual RAID controllers, which provide storage management logic. The DXi6900 G1/G2 includes 0 to 13 Expansion modules (EBODs), which connect in a chain to the Array modules, and which provide additional storage capacity only. The DXi6900-S includes 0 to 6 Expansion modules (EBODs), which connect in a chain to the Array modules, and which provide additional storage capacity only.

---

**i Note:** Storage capacity is licensed in 17 TB (DXi6900 G1/G2) increments (see [License Keys on page 377](#)). To purchase a storage capacity upgrade license, contact Quantum Customer Support.

**i Note:** Storage capacity is licensed in 34 TB (DXi6900-S) increments (see [License Keys on page 377](#)). To purchase a storage capacity upgrade license, contact Quantum Customer Support.

The DXi6900 Array and Expansion modules have a series of LED indicators and buttons located on the front and back of each component:

- [DXi6900 Array and Expansion Module Front Panel Features and Indicators on the next page](#)
- [Array and Expansion Module Hard Drive Carrier Indicators on page 56](#)

- [Array Module Rear Panel Indicators on page 57](#)
- [Expansion Module Rear Panel Indicators on page 59](#)

## DXi6900 Array and Expansion Module Front Panel Features and Indicators

LED indicators and buttons are located behind the optional rack bezel on the front of the Array modules (RBODs) and Expansion modules (EBODs) (see [Figure 26 below](#) and [Table 1 below](#)).

**Figure 26:** DXi6900 Array and Expansion Module LED Indicators – Front Panel

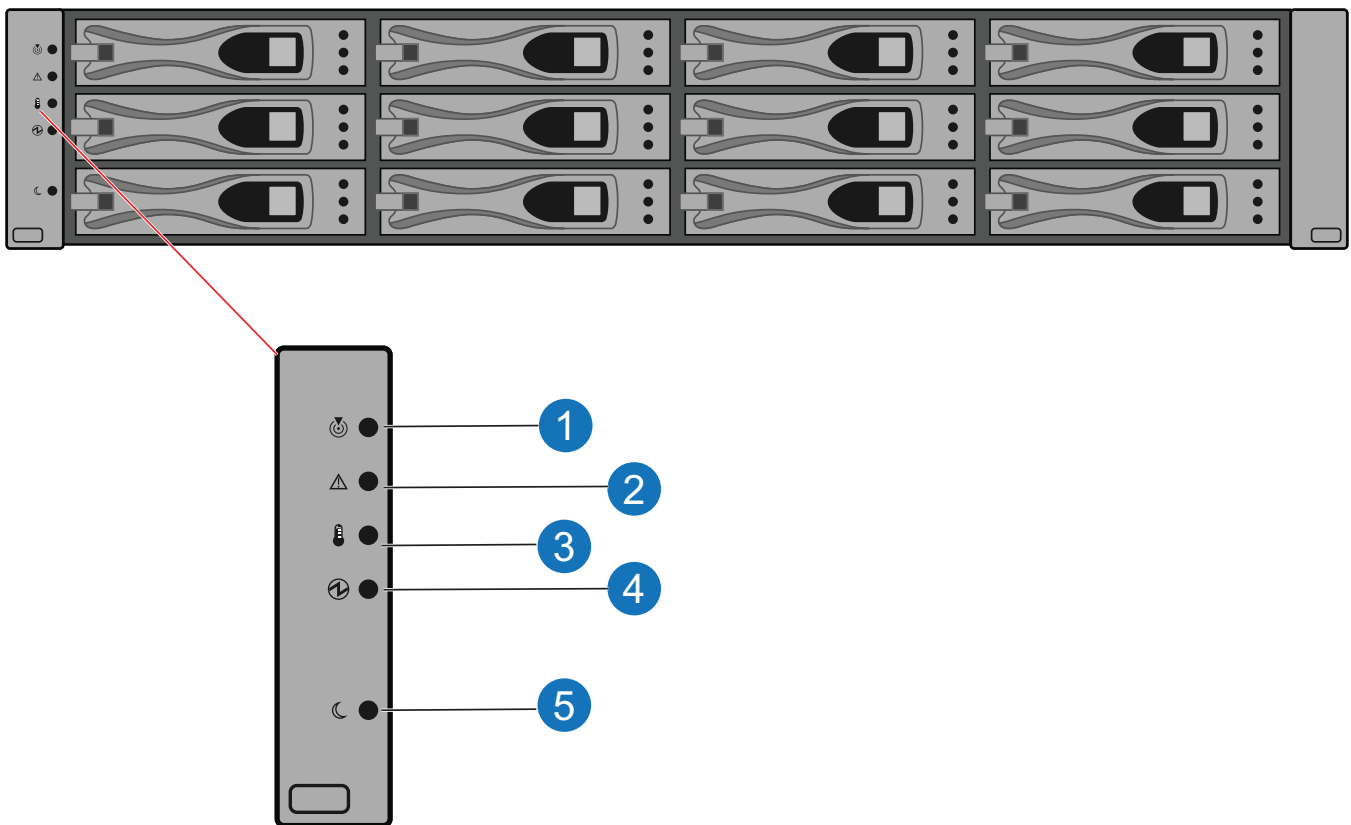

**Table 1:** Array and Expansion Module LEDs and Buttons

Item	Button/LED	Description
1	Enclosure locate (white)	Indicates the location of the enclosure within the system.
2	Service action required (amber)	Indicates at least one of the components within the enclosure has detected a fault.

Item	Button/LED	Description
3	Over temperature (amber)	Indicates the environmental temperature has reached an unsafe level.
4	Power (green)	Indicates the enclosure has main power.
5	Standby power (green)	Indicates that the enclosure is in standby mode.

## Array and Expansion Module Hard Drive Carrier Indicators

The individual hard drive sleds contain LEDs that indicate the health condition of the hard drive (see [Figure 27 below](#) and [Table 1 below](#)).

**Figure 27:** Hard Drive Sled LEDs

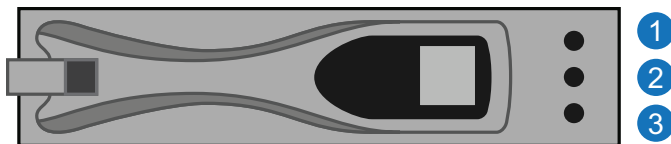

**Table 1:** Hard Drive Sled LEDs

LED	Description
LEDs off	<b>Solid</b> – It is safe to remove the hard drive from the array for service.
Drive service action allowed LED (blue)	<b>Solid</b> – It is safe to remove the hard drive from the array for service.
Drive fault (amber)	<b>Solid</b> – The hard drive has failed and a service ticket is created. Contact Quantum customer support. <b>Blinking</b> – Drive volume or Array module locate function.
Drive active LED (green)	<b>Solid</b> – No activity on the hard drive. <b>Blinking</b> – There is activity on the hard drive. <b>i Note:</b> It is normal to see drive activity even when the DXi is not reading or writing data.

**⚠ Caution:** Do not remove a hard drive that has not failed. Instead, only remove a drive that has failed. If you accidentally remove a good drive, wait 30 seconds before reinserting the drive.



# Array Module Rear Panel Indicators

LED indicators and buttons are located on the back of the Array modules (RBODs) (see [Figure 28 below](#) and [Table 1 below](#)).

**Figure 28:** Array Module LED Indicators – Rear Panel

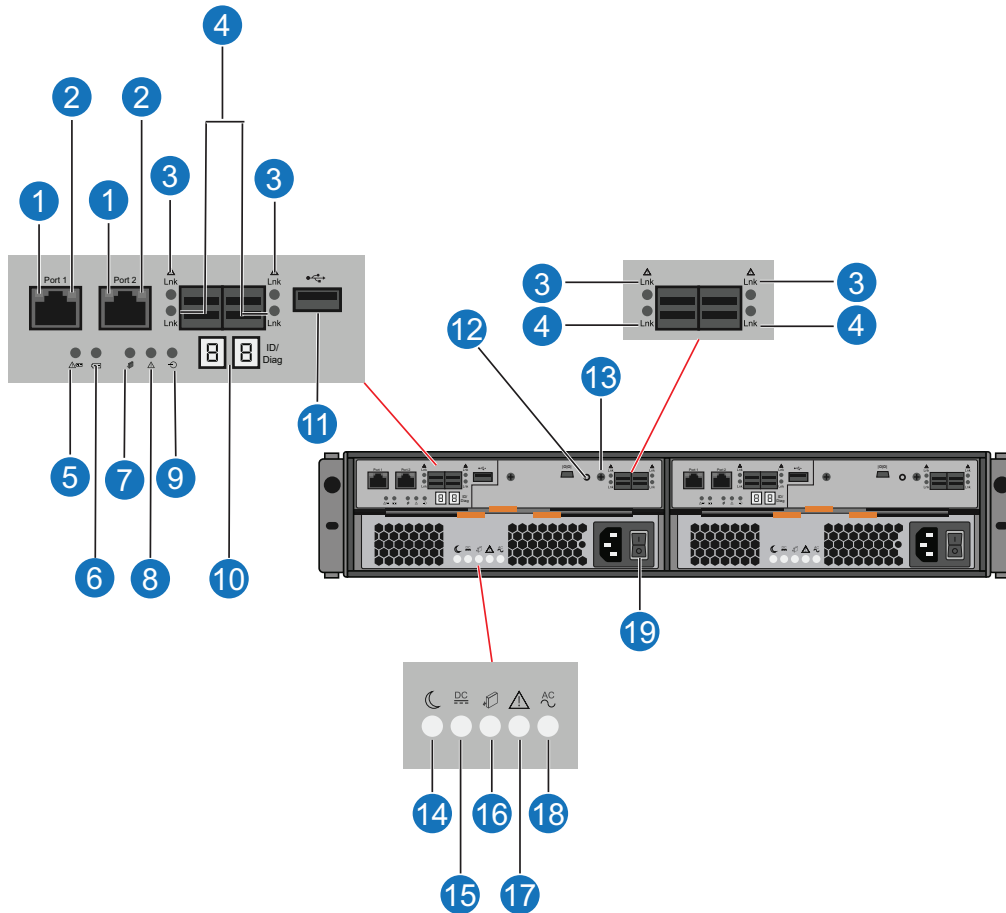

**Table 1:** Array Module LEDs and Buttons

Item	Button/LEDs	Description
1	Ethernet link rate (green)	<b>Solid</b> - port speed 1000MB/sec. <b>Off</b> - port speed 10/100MB/sec.
2	Ethernet activity (green)	<b>Solid</b> - link established. <b>Blinking</b> - indicates port activity.
3	SAS host/expansion fault (amber)	<b>Both Off</b> - cable unplugged. <b>Fault Off and Activity On</b> - all links operating.  <b>Fault On and Activity Off</b> - at least one link active and at least one link fault.

Item	Button/LEDs	Description
4	SAS host/expansion activity (green)	<b>Both Off</b> - cable unplugged. Fault Off and Activity On - all links operating. <b>Fault On and Activity Off</b> - at least one link active and at least one link fault.
5	Battery fault (amber)	<b>On</b> - battery has failed. <b>Off</b> - battery operating as normal.
6	Battery charging (green)	<b>Blinking</b> - battery is charging. <b>On</b> - battery is fully charged. <b>Off</b> - battery fault or no battery
7	Service action allowed (blue)	<b>Solid</b> - safe for Quantum field service. to remove controller from slot.
8	Service action required (amber)	<b>Solid</b> - controller has failed and requires attention. Fault light will be on during power up and will turn off after self-test sequence completes.
9	Cache active (green)	<b>Solid</b> - unwritten data is stored in cache. <b>Blinking</b> - during AC power failure, cache offload is occurring.
10	Seven segment display (green)	Displays tray ID and error code. (Displays <b>99</b> when the Array module is operating normally.)
11	USB	Not used.
12	Mini USB	Not used.
13	Reset switch	Not used.
14	Standby power (green)	<b>Solid</b> - main DC power is off and 5V standby power is on.
15	DC enabled (green)	<b>Solid</b> - DC power rails are within specified limits.
16	Service action allowed (blue)	<b>Solid</b> - safe for Quantum field service. to remove power supply from slot.
17	Service action required (amber)	<b>Solid</b> - power supply has failed and requires attention.
18	AC enabled (green)	<b>Solid</b> - power is being applied to the power supply and the power switch is on.
19	Power switch	Module power switch.

# Expansion Module Rear Panel Indicators

LED indicators and buttons are located on the back of the Expansion modules (EBODs) (see [Figure 29 below](#) and [Table 1 below](#)).

**Figure 29:** Expansion Module LED Indicators – Rear Panel

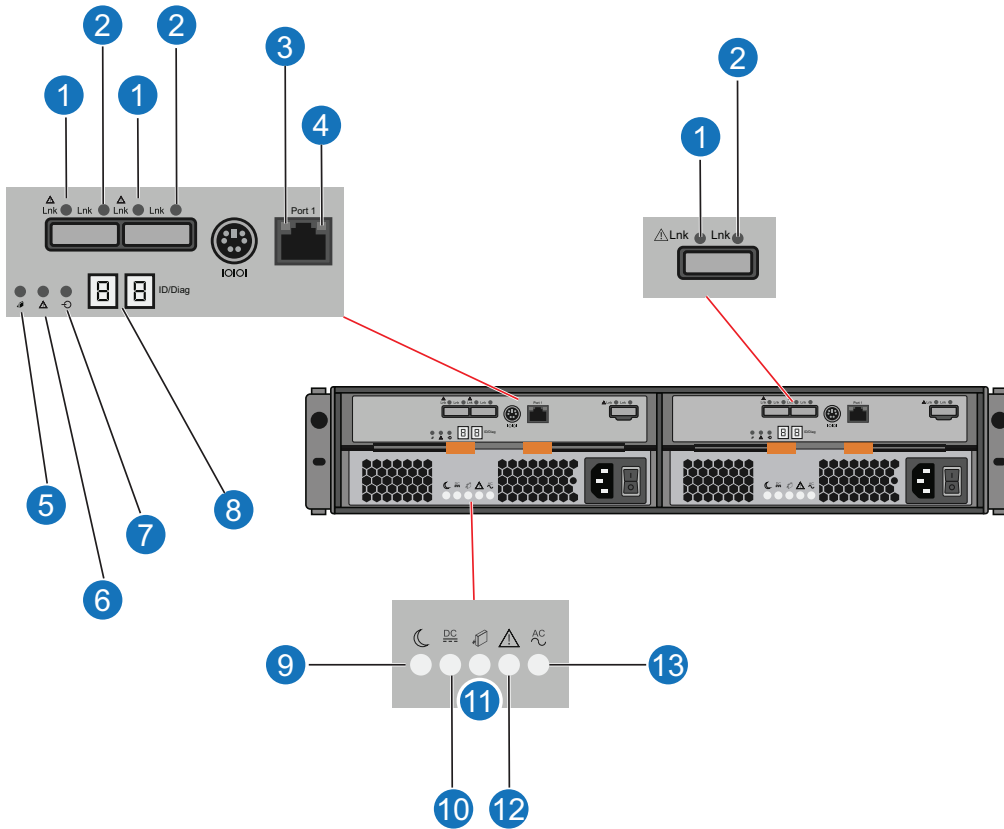

**Table 1:** Expansion Module LEDs and Buttons

Items	Button/LED	Description
1	SAS host/expiration fault (amber)	<p><b>Both Off</b> - cable unplugged.</p> <p><b>Fault Off and Activity On</b> - all links operating.</p> <p><b>Fault On and Activity Off</b> - at least one link active and at least one link fault.</p>
2	SAS host/expiration activity (green)	<p><b>Both Off</b> - cable unplugged.</p> <p><b>Fault Off and Activity On</b> - all links operating.</p> <p><b>Fault On and Activity Off</b> - at least one link active and at least one link fault.</p>

Items	Button/LED	Description
3	Ethernet link rate (green)	<b>Solid</b> - port speed 1000MB/sec. <b>Off</b> - port speed 10/100MB/sec.
4	Ethernet activity (green)	<b>Solid</b> - link established. <b>Blinking</b> - indicates port activity.
5	Service action allowed (blue)	<b>Solid</b> - safe for Quantum field service. to remove ESM from slot.
6	Service action required (amber)	<b>Solid</b> - ESM has failed and requires attention. <b>i Note:</b> Fault light will be on during power up and will turn off after self-test sequence completes.
7	Power (green)	<b>Solid</b> - power is being applied to the ESM.
8	Seven segment display (green)	Displays tray ID and error code. (Displays <b>00</b> when the Array module is operating normally.)
9	Standby power (green)	<b>Solid</b> - main DC power is off and 5V standby power is on.
10	DC enabled (green)	<b>Solid</b> - DC power rails are within specified limits.
11	Service action allowed (blue)	<b>Solid</b> - safe for Quantum field service. to remove power supply from slot.
12	Service action required (amber)	<b>Solid</b> - power supply has failed and requires attention.
13	AC enabled (green)	<b>Solid</b> - power is being applied to the power supply and the power switch is on.
14	Power switch	Module power switch.

---

## Turning On and Shutting Down the DXi6900

To turn on or shut down the DXi6900, refer to the following sections:

- [Turning On the DXi6900 on the next page](#)
- [Turning Off the DXi6900 on page 62](#)

## Turning On the DXi6900

To turn on the system, power on the DXi6900 system components in the following order:

1. Turn on both power switches on the back of each Expansion module (EBOD) (see [Figure 30 below](#)). Wait until the seven segment display on the rear of the module displays **00** (approximately 1 minute).
2. Turn on both power switches on the back of each Array module (RBOD) (see [Figure 31 below](#)). Wait until the seven segment display on the rear of the module displays **99** (approximately 3 minutes).
3. Press the power button on the front of the Node (see [Figure 32 on the next page](#)). Wait for the system to boot before attempting to log on.

**i Note:** The system can take approximately 30 minutes to start up, depending on the amount of installed storage capacity.

The system is now ready for operation.

**Figure 30:** Powering on the DXi6900 Expansion Modules (EBODs)

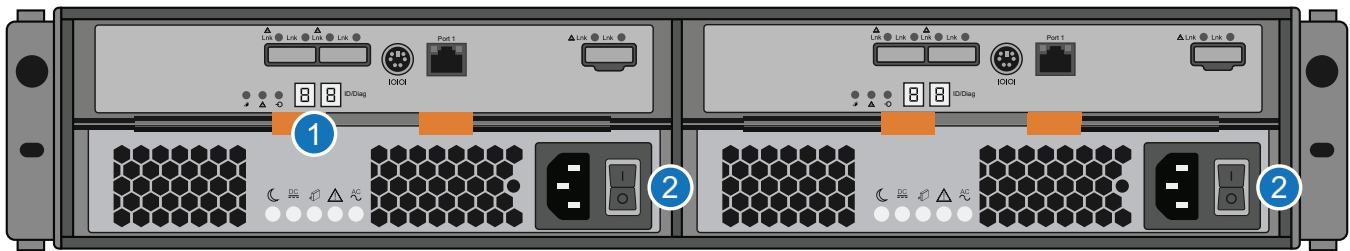

1. Seven Segment Display
2. Power Switches

**Figure 31:** Powering on the DXi6900 Array Modules (RBODs)

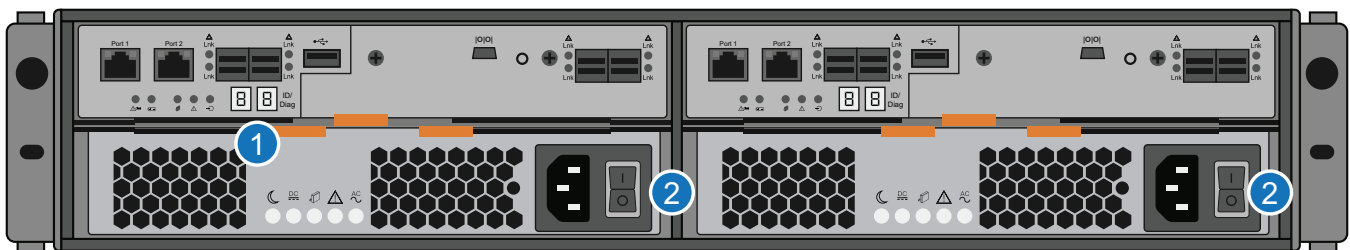

1. Seven Segment Display
2. Power Switches

**Figure 32:** Powering on the DXi6900 Node

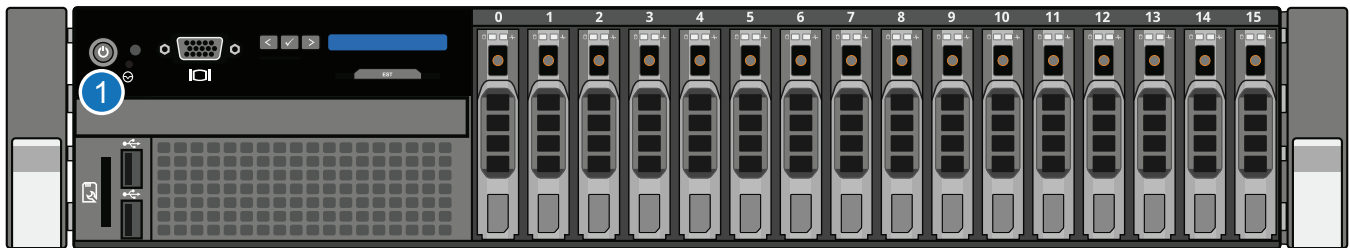

**1. Power Switch**

## Turning Off the DXi6900

Before shutting down the DXi6900, make sure that all backup and replication jobs are finished, and that space reclamation activity is complete.

1. Shut down the system from the remote management console using the **Shutdown** option on the **Utilities > Reboot & Shutdown** page.

**i Note:** Shutting down the system can take up to 15 minutes. Only the Node will completely shut down.

2. After the Node shuts down, turn off both power switches on the back of each Array module (RBOD). Wait until the seven segment display on the rear of the module turns off.
3. Turn off both power switches on the back of each Expansion module (EBOD).

---

## Locating DXi6900 Serial Numbers

You will need the system serial number, the Node serial number, and the Expansion module serial number at various times:

<b>System Serial Number</b>	You need this number to contact Quantum Support or to add a licensed feature.
<b>Node Serial Number</b>	You need this number for a Node replacement component.
<b>Expansion Module (JBOD) Serial Number</b>	You need this number for an Expansion module replacement component.

You can locate the system serial number on the **Home** page of the remote management console.

You can also locate the system serial number, the Node serial number, and the Array and Expansion module serial numbers by looking at the physical components.

- The system serial number is located on the pull-out information tag on the front of the Node . The text **Service Call System Serial Number** appears on the label. The system serial number includes the letters **BVV S** (DXi6900-S), **BVV** (DXi6900 G2) or **BVT** (DXi6900 G1)
- The Node serial number is located to the left of the SAS ports on the rear of the Node. It is the same as the Node service tag.
- The Array module (RBOD) and Expansion module (EBOD) serial number is located on front top of the module and on the rear lip of the module.

**i Note:** The system serial number also appears on the location ID label that is affixed to the lip on the rear of the Node and each Expansion module.

**Figure 33:** DXi6900 Node Information Tag



**1 - Information Tag Pullout with System Serial Number**



# Chapter 3: Remote Management

---

This chapter contains the following topics:

DXi6900 Remote Management Overview .....	64
Accessing Remote Management .....	65
The Remote Management Console .....	70

---

## DXi6900 Remote Management Overview

The Quantum DXi6900 provides a powerful Web-based user interface that allows you to configure and manage the system from a remote workstation on the same network as the DXi6900.

Use the DXi6900 remote management console to perform the following tasks:

- Set up the DXi6900 using guided procedures (see [Configuration Wizards on page 79](#)).
- View important system information at a glance (see [Home Page on page 125](#)).
- Manage data replication activities (see [Replication on page 138](#)).
- Monitor hardware status and system performance (see [Status on page 177](#)).
- View administration alerts and resolve service tickets (see [Admin Alerts Page on page 206](#)).
- Configure storage presentation, data replication, and system settings (see [DXi6900 Configuration Overview on page 214](#)).
- Run diagnostic tools and maintain the system (see [DXi6900 Utilities Overview on page 366](#)).



---

# Accessing Remote Management

Access the remote management console using a Web browser on a workstation that is on the same network as the DXi6900.

## Supported Browsers

Web browser software is not included with the DXi6900. You must obtain and install it separately. The DXi6900 remote management console supports the following Web browsers:

- Mozilla Firefox 36 or later
- Google Chrome 40 or later
- Microsoft Internet Explorer 10 with SSL 3.0 disabled (enabled by default) and higher.

### Web Browser Tips:

- If you are experiencing browser issues, please update to the latest browser version.
- For correct operation of the remote management console, including the display of the online help, disable any pop-up blockers and enable JavaScript in your Web browser. In the Google Chrome browser, the DXi help may not appear when Help is selected. If this occurs, select **Settings > Show Advanced Setting > Privacy > Pop-ups > Manage Exceptions**. Add the DXi IP address to the exceptions box, select **Allow**, and click **Done**.

## Logging On to the DXi6900

1. Launch a supported Web browser on a workstation that has network access to the DXi6900.
2. In the browser address box, type the IP address of the DXi6900, and then press **<Enter>**.

The **Login** window displays (see [Figure 34 on the next page](#)).

**Figure 34:** Login Window

U.S. Pat. No.: 5,990,810

If the **Login** window does not display, verify that the IP address is correct and that the network path to the DXi6900 is valid. Also verify that you are using a supported Web browser. Then try again. If you are still unable to access the **Login** window, contact your administrator.

---

**i Note:** The default IP address is **10.1.1.1**. The IP address can be changed during installation using the **Getting Started Wizard** or at a later time on the **Network** page (see [Network on page 322](#)).

3. Select the login type and enter the corresponding password.
  - **Monitor** - Allowed to view information on the DXi6900 remote management console but cannot make changes.
  - **Administrator** - Allowed to view and change information on the DXi6900 remote management console.
  - **Service** - Allowed to view and change information on the DXi6900 remote management console. Password changes are not allowed.

---

**i Note:** Passwords are limited to 32 characters. Alphanumeric characters and special characters are allowed. Passwords can be changed on the **Access Control** page (see [Security on page 335](#)).

4. Click **Login**.
5. If a security banner message has been specified for the DXi6900, click **Accept**.  
For information about specifying a security banner message, see [Security Notice on page 352](#).  
The **Home** page displays (see [Figure 35 on the next page](#)).

Figure 35: DXi6900 Home Page

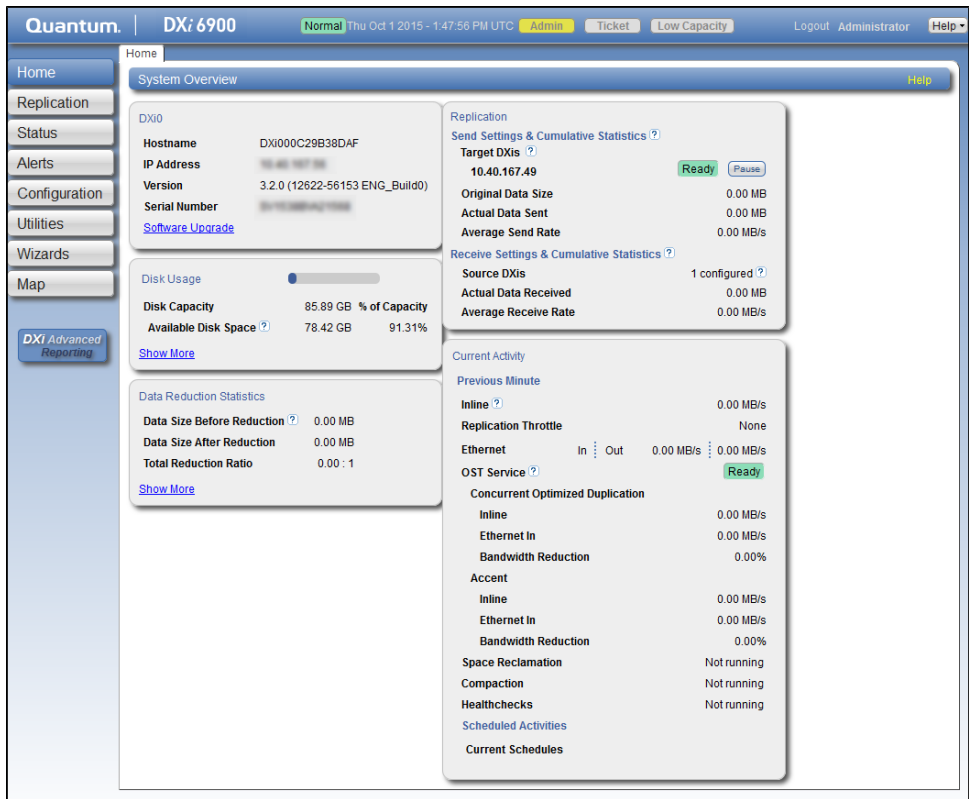

Chapter 3: Remote Management  
 Accessing Remote Management

Quantum | DXi 6900-S | Attention | Tue Jul 5 2016 - 13:43:38 PDT | Admin | Ticket | Low Capacity | Logout | Administrator | Help

Home

System Overview Help

DXi6900-S

Hostname: hyades  
 IP Address: [Redacted]  
 Version: 3.2.4 (13227-57673 Build7)  
 Serial Number: [Redacted]  
 Data-at-Rest Encryption: Disabled  
[Software Upgrade](#)

Disk Usage

Disk Capacity: 68.08 TB % of Capacity  
 Available Disk Space: 68.06 TB 99.97%  
[Show More](#)

Data Reduction Statistics

Data Size Before Reduction: 593.33 GB  
 Data Size After Reduction: 778.06 MB  
 Total Reduction Ratio: 762.58 : 1  
[Show More](#)

Replication

Send Settings & Cumulative Statistics

Target DXis	None
Original Data Size	0.00 MB
Actual Data Sent	0.00 MB
Average Send Rate	0.00 MB/s

Receive Settings & Cumulative Statistics

Source DXis	None
Actual Data Received	0.00 MB
Average Receive Rate	0.00 MB/s

Current Activity

Previous Minute

Inline: 0.00 MB/s

Replication Throttle: None

Ethernet: In: Out 0.00 MB/s : 0.00 MB/s

Fibre Channel: In: Out 0.00 MB/s : 0.00 MB/s

OST Service: **Ready**

Concurrent Optimized Duplication

Inline: 0.00 MB/s

Ethernet In: 0.00 MB/s

Bandwidth Reduction: 0.00%

Space Reclamation: 10% complete

Compaction: Not running

Healthchecks: Not running

[Scheduled Activities](#)

Current Schedules

Advanced Reporting

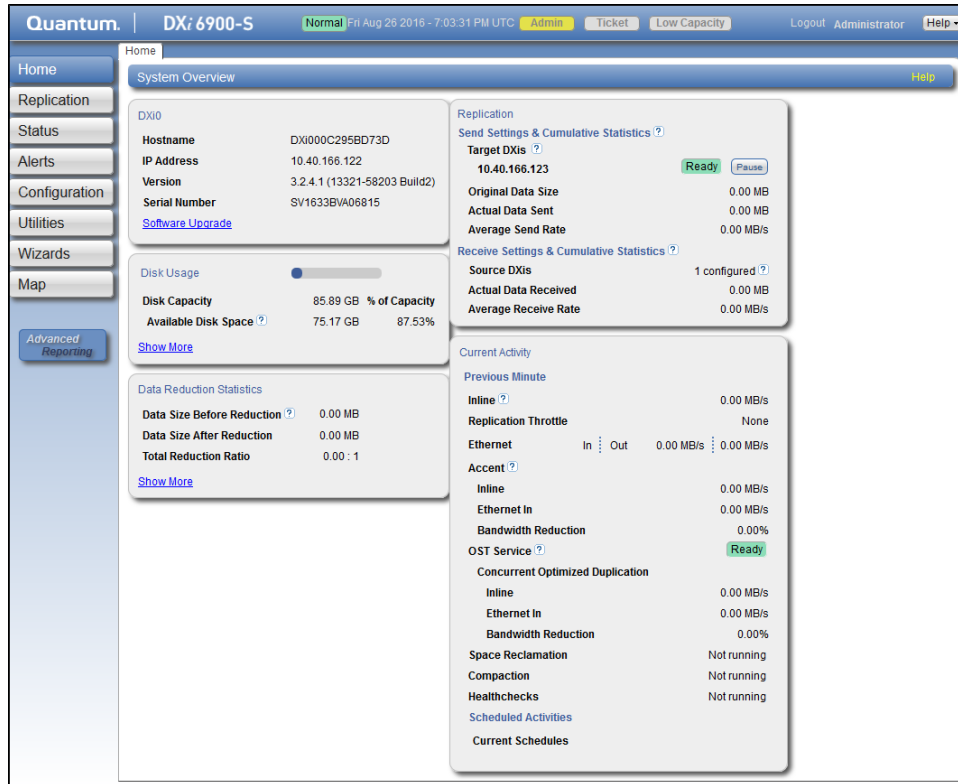

If you are unable to log on, verify that the password is correct, then try again. If you are still unable to log on, contact your DXi6900 administrator.

**Caution:** More than one Administrator can log on to the DXi at a time. If two Administrators attempt to make configuration changes on the same page at the same time, it is possible that one Administrator's changes will overwrite the other's. Always coordinate configuration changes with other Administrator users.

## Logging Off of the DXi6900

When you are done working in the DXi6900 remote management console, click **Logout** on the upper right of the remote management console to end your session.

### Additional Information

- If the DXi6900 remote management console is idle for more than 30 minutes (default setting), the system logs off the user. The inactivity timeout can be changed on the **Login Session** page.
- There is no inactivity timeout for CLI Administrator logins over Secure Shell (SSH).

# The Remote Management Console

After you log on to the DXi6900, the remote management console displays. The remote management console includes the following features:

## System Banner

The system banner displays at the top of the remote management console (see [Figure 36 below](#)). Use the system banner to see overall system status and alert information at a glance, and to quickly access additional information. The system banner also displays the time and date as well as the login type (administrator or monitor).

**Figure 36:** System Banner

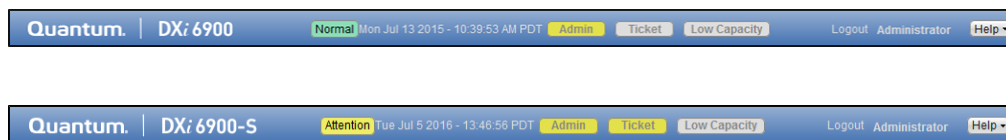

The following items display on the system banner.

Item	Description
<b>Model Number</b>	The model number of the DXi6900 (see <a href="#">Model Number on the next page</a> ).
<b>Status</b>	<p>Displays the operating state of the DXi6900:</p> <ul style="list-style-type: none"><li>• <b>Normal</b> - (Green) The system is operating correctly.</li><li>• <b>Attention</b> - (Yellow) There is a problem with the system. <b>i Note:</b> The state displays Attention during a blockpool verify operation (see <a href="#">Blockpool Verify Behavior on page 73</a>).</li><li>• <b>Verify Failure</b> - (Red) The blockpool verify process has failed.</li><li>• <b>Low Space</b> - (Yellow) Available disk space is low. Ingest and replication continue, and space reclamation starts.</li><li>• <b>Critical Reserve Space</b> - (Red) Available disk space is critically low. Ingest and replication are stopped, and space reclamation continues.</li><li>• <b>No Space</b> - (Red) There is no available disk space. Ingest and replication are stopped, and space reclamation continues.</li></ul> <p>Click the <b>Status</b> button to display detailed status information about the system (see <a href="#">Hardware on page 178</a>).</p>

Item	Description
<b>Admin</b>	The <b>Admin</b> button turns yellow when an administration alert occurs. Click the <b>Admin</b> button to manage administration alerts (see <a href="#">Admin Alerts on page 206</a> ).
<b>Ticket</b>	The <b>Ticket</b> button turns yellow when open service tickets are present. Click the <b>Ticket</b> button to manage service tickets (see <a href="#">Service Tickets on page 207</a> ).
<b>Low Capacity</b>	<p>The <b>Low Capacity</b> button turns yellow when available disk space falls to a low level and the DXi enters <b>Low Space</b> state (see <a href="#">Low Space Management on the next page</a>). Click the <b>Low Capacity</b> button to view the administration alerts related to low disk space (see <a href="#">Admin Alerts on page 206</a>).</p> <p><b>i Note:</b> When disk space is low, target replication to the system is paused (see <a href="#">Replication Service on page 174</a>). In addition, space reclamation and compaction are automatically started to free up disk space (see <a href="#">Space Reclamation on page 374</a>).</p>
<b>Logout</b>	Click to end your remote management session.
<b>Help Menu</b>	<p>Select from the following help options:</p> <ul style="list-style-type: none"> <li>• <b>Help Contents</b> - Open the DXi6900 online help.</li> <li>• <b>Online Documentation</b> - Access documentation resources on the Quantum Web site.</li> <li>• <b>About</b> - Display DXi software version information.</li> </ul>

## Model Number

The Model Number displays in the DXi6900 **System Overview** section on the **Home** page. The model number indicates the specific hardware configuration of the DXi6900.

The table below describes the DXi6900 hardware configuration that is indicated by each model number.

**Table 1:** DXi6900 Model Number

DXi6900 Model Number	DXi6900 Configuration
DXi6900 G1	<p>17–510 TB usable for data storage</p> <p>3 x 1 GbE Ethernet ports</p> <p>2 x 10 GbE Ethernet ports</p> <p>(Optional) Additional 4 x 1 GbE Ethernet ports or 2 x 10 GbE Ethernet ports</p> <p>(Optional) 2 x 10 GBase-T Ethernet ports</p> <p>4 x 8 Gb or 2 x 16 Gb Fibre Channel ports (for VTL)</p> <p>2 x 8 Gb or 2 x 16 Gb Fibre Channel ports (for path to tape, also configurable for VTL)</p>

DXi6900 Model Number	DXi6900 Configuration
DXi6900 G2	17–510 TB usable for data storage 3 x 1 GbE Ethernet ports (Optional) Up to an additional 6 x 10 GbE Ethernet ports. (Optional) Up to an additional 6 x 10 GBase-T Ethernet ports. (Optional) Up to an additional 6 x 16 Gb Fibre Channel ports (for path to tape and VTL)
DXi6900-S	34–544 TB usable for data storage 3 x 1 GbE Ethernet ports (Optional) Up to an additional 6 x 10 GbE Ethernet ports. (Optional) Up to an additional 6 x 10 GBase-T Ethernet ports. (Optional) Up to an additional 6 x 16 Gb Fibre Channel ports (for path to tape and VTL)

### Low Space Management

As disk capacity is used and free disk space approaches low levels, the DXi6900 automatically responds as detailed in the table below.

When the DXi6900 enters the **Low Space** state, space reclamation and compaction are automatically started to free up disk space (see [Space Reclamation on page 374](#)). Space reclamation and compaction end when the DXi6900 exits the **Low Space** state.

When the DXi6900 enters the **Critical Reserve Space** state, backup ingest is stopped, and target replication to the system is paused. Backup ingest and target replication resume when the DXi6900 exits the **Critical Reserve Space** state.

**i Note:** The system generates a service ticket and an admin alert when it enters the **Low Space**, **Critical Reserve Space**, and **No Space** states. In addition, a service ticket and an admin alert are generated when Used Disk Space reaches 85% and 95% of total disk capacity.

DXi6900 State	Disk Space Level	System Actions
<b>Normal</b> (Green)	Normal disk space	<b>Low Capacity</b> button is dark. Backup ingest and replication occur as normal. Space reclamation occurs at normally scheduled times.



DXi6900 State	Disk Space Level	System Actions
<b>Low Space</b> (Yellow)	Free Space is less than: 500 GB + 100 GB x (total usable capacity in TB / 10 TB)	<b>Low Capacity</b> button is lit. Backup ingest and replication occur as normal. Space reclamation is automatically started.
<b>Critical Reserve Space</b> (Red)	Free Space is less than: 250 GB	<b>Low Capacity</b> button is lit. Backup ingest and replication are stopped. Space reclamation is automatically started. <b>i Note:</b> VTL cartridge metadata files may still be updated.
<b>No Space</b> (Red)	Free Space is less than: 10 GB <b>i Note:</b> <b>No Space</b> also occurs if the Used Metadata percentage is 85% or greater.	<b>Low Capacity</b> button is lit. Backup ingest and replication are stopped. Space reclamation is automatically started. <b>i Note:</b> VTL cartridge metadata files <i>may not</i> be updated.

### Blockpool Verify Behavior

A blockpool verify operation occurs if data on the system requires repair, for example, after an unexpected shutdown due to a power loss. During a blockpool verify operation, the banner displays the **Attention** state. Clicking **Attention** displays the message: *A previous unclean shutdown of the DXi has required a data verification to commence. While in this condition the DXi is operational, but performance may be severely degraded.*

While a blockpool verify operation is in progress, some system operations are affected.

- Mounting VTL cartridges created prior to the blockpool verify may fail.
- Retrieving data created prior to the blockpool verify may fail.
- Creating and mounting new VTL cartridges should succeed.
- Ingesting new data to new VTL cartridges or using NAS/OST should succeed.
- Sending data that existed prior to the blockpool verify to a replication target may fail.

- Sending new data to a replication target, or receiving replicated data, should succeed.
- Space reclamation and healthchecks will fail.

When the blockpool verify is complete, the banner displays Normal, and the system resumes normal operation

## Main Menu

The main menu displays on the left side of the DXi6900 remote management console (see [Figure 37 below](#)). Click a menu item to display the corresponding management page.

To access **DXi Advanced Reporting**, click the link below the main menu. Quantum DXi Advanced Reporting provides performance data logging and visual reporting and graphing features for Quantum DXi-Series systems. For more information, see the *Quantum DXi Advanced Reporting User's Guide (6-67353)*.

**Note:** Clicking **Wizards** on the main menu replaces the main menu with the wizards menu. Click a menu item to begin a wizard, or click **Exit** to return to the main menu (see [Configuration Wizards on page 79](#)).

Figure 37: Main Menu

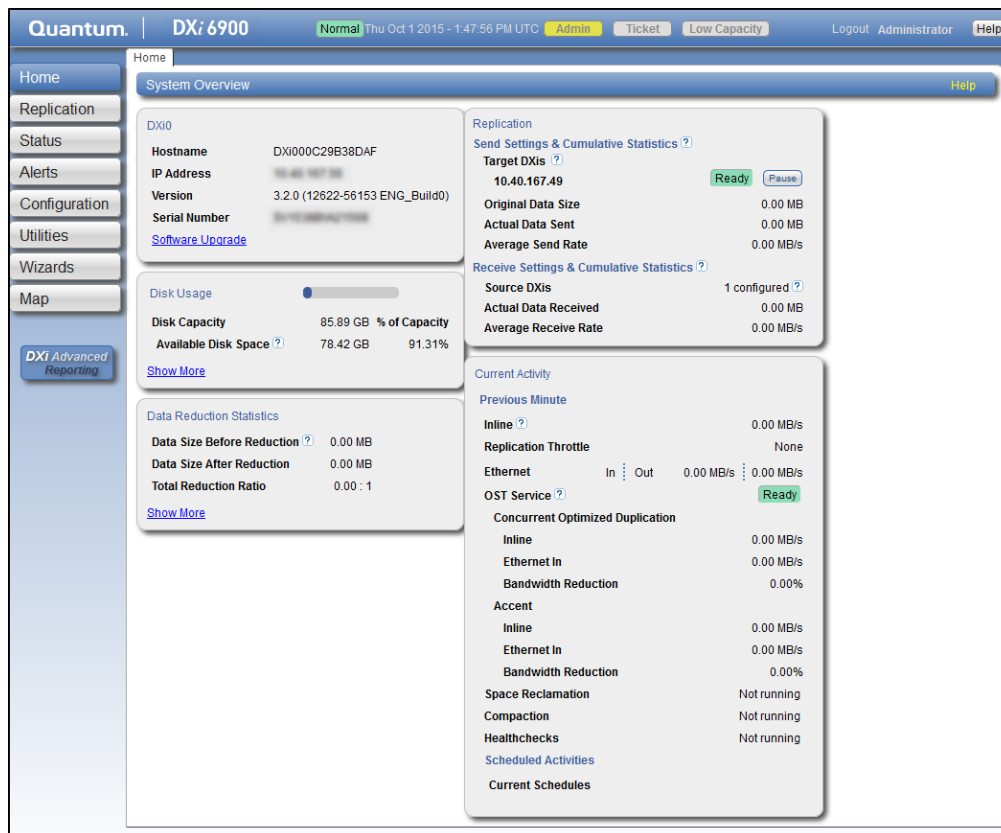

Chapter 3: Remote Management  
The Remote Management Console

The screenshot displays the Quantum DXi6900-S Remote Management Console interface. The top navigation bar includes the Quantum logo, the device name 'DXi6900-S', a status indicator 'Attention' with a timestamp 'Tue Jul 5 2016 - 13:43:38 PDT', and user options 'Admin', 'Ticket', 'Low Capacity', 'Logout', 'Administrator', and 'Help'.

The left sidebar contains a menu with the following items: Home, Replication, Status, Alerts, Configuration, Utilities, Wizards, and Map. An 'Advanced Reporting' button is located below the 'Map' item.

The main content area is titled 'System Overview' and is divided into several sections:

- DXi6900-S System Information:**
  - Hostname: hyades
  - IP Address: [Redacted]
  - Version: 3.2.4 (13227-57673 Build7)
  - Serial Number: [Redacted]
  - Data-at-Rest Encryption: Disabled
  - Software Upgrade: [Link]
- Disk Usage:**
  - Disk Capacity: 68.08 TB
  - Available Disk Space: 68.06 TB (99.97% of Capacity)
  - Show More: [Link]
- Data Reduction Statistics:**
  - Data Size Before Reduction: 593.33 GB
  - Data Size After Reduction: 778.06 MB
  - Total Reduction Ratio: 762.58 : 1
  - Show More: [Link]
- Replication:**
  - Send Settings & Cumulative Statistics:
    - Target DXIs: None
    - Original Data Size: 0.00 MB
    - Actual Data Sent: 0.00 MB
    - Average Send Rate: 0.00 MB/s
  - Receive Settings & Cumulative Statistics:
    - Source DXIs: None
    - Actual Data Received: 0.00 MB
    - Average Receive Rate: 0.00 MB/s
- Current Activity:**
  - Previous Minute:
    - Inline: 0.00 MB/s
    - Replication Throttle: None
    - Ethernet: In: 0.00 MB/s, Out: 0.00 MB/s
    - Fibre Channel: In: 0.00 MB/s, Out: 0.00 MB/s
    - OST Service: Ready
  - Concurrent Optimized Duplication:
    - Inline: 0.00 MB/s
    - Ethernet In: 0.00 MB/s
    - Bandwidth Reduction: 0.00%
    - Space Reclamation: 10% complete
    - Compaction: Not running
    - Healthchecks: Not running
  - Scheduled Activities: [Link]
  - Current Schedules: [Link]

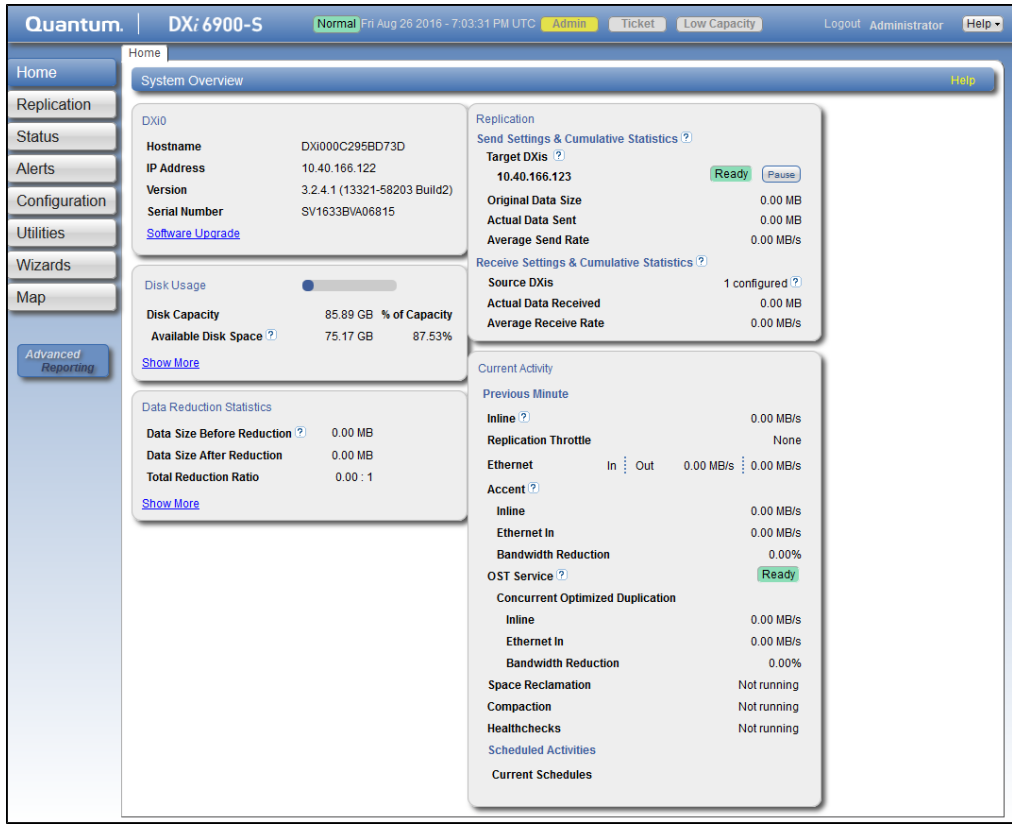

## Management Pages

Use the DXi6900 management pages to view information as well as configure and manage the system. To navigate to a page, first click a menu item, then click a tab to display the corresponding page. Some pages include sub-tabs that display pages with additional information and options.

To view a graphical map of all remote management pages, click **Map** on the main menu (see ). On the map, click the name of a page to quickly navigate to that page (see [Figure 38 on the next page](#)).

If you need help as you work, click **Help** in the page's title bar to see online help for that page. In addition, Quick Tips are available on many pages. Click the **Quick Tip** icon [?] next to a section or field to learn more about that item.

**Caution:** Unless directed to do so by the documentation, do not use your Web browser's **Back**, **Forward**, or **Refresh** buttons when navigating in the remote management console. Doing so may have unintended effects. Instead, always use the main menu and tabs to navigate in the remote management console.

**Figure 38:** Remote Management Pages Map

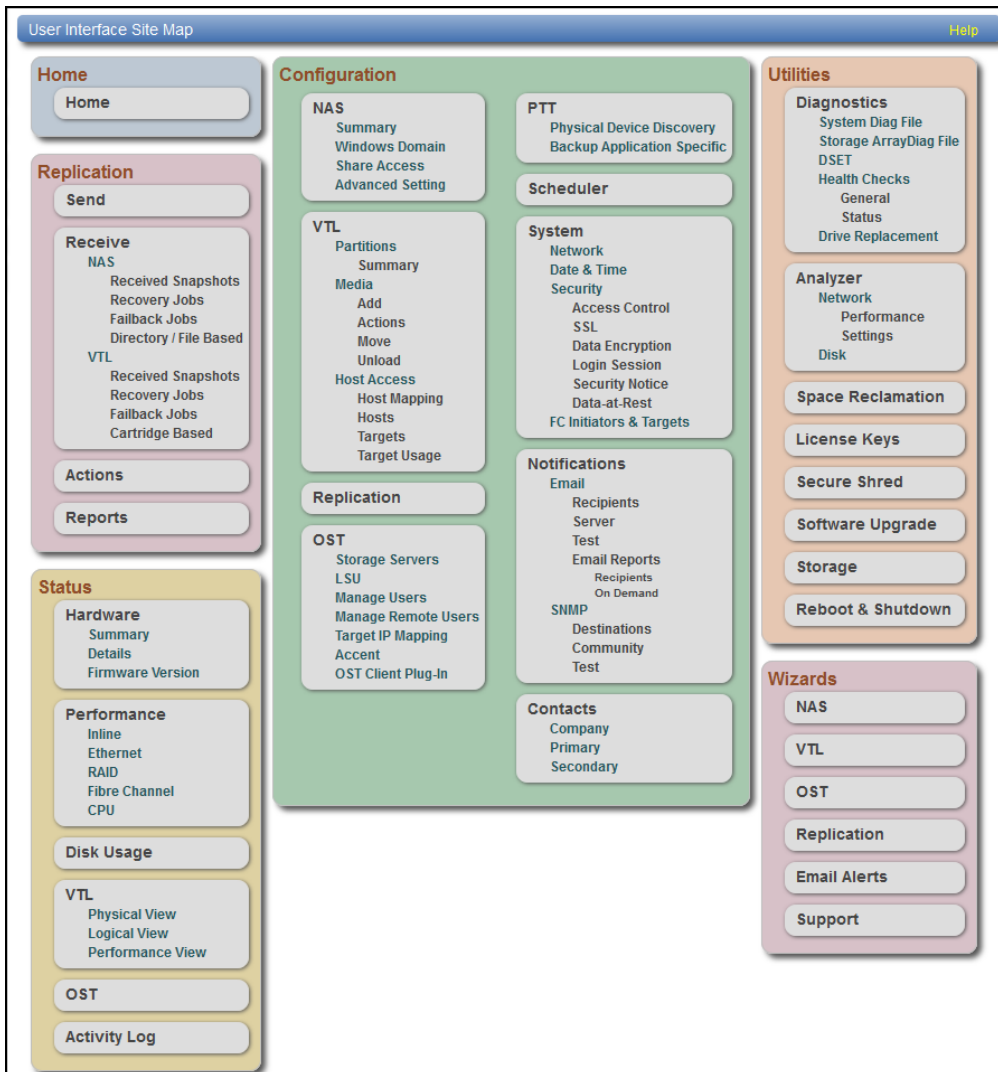

# Chapter 3: Remote Management

## The Remote Management Console

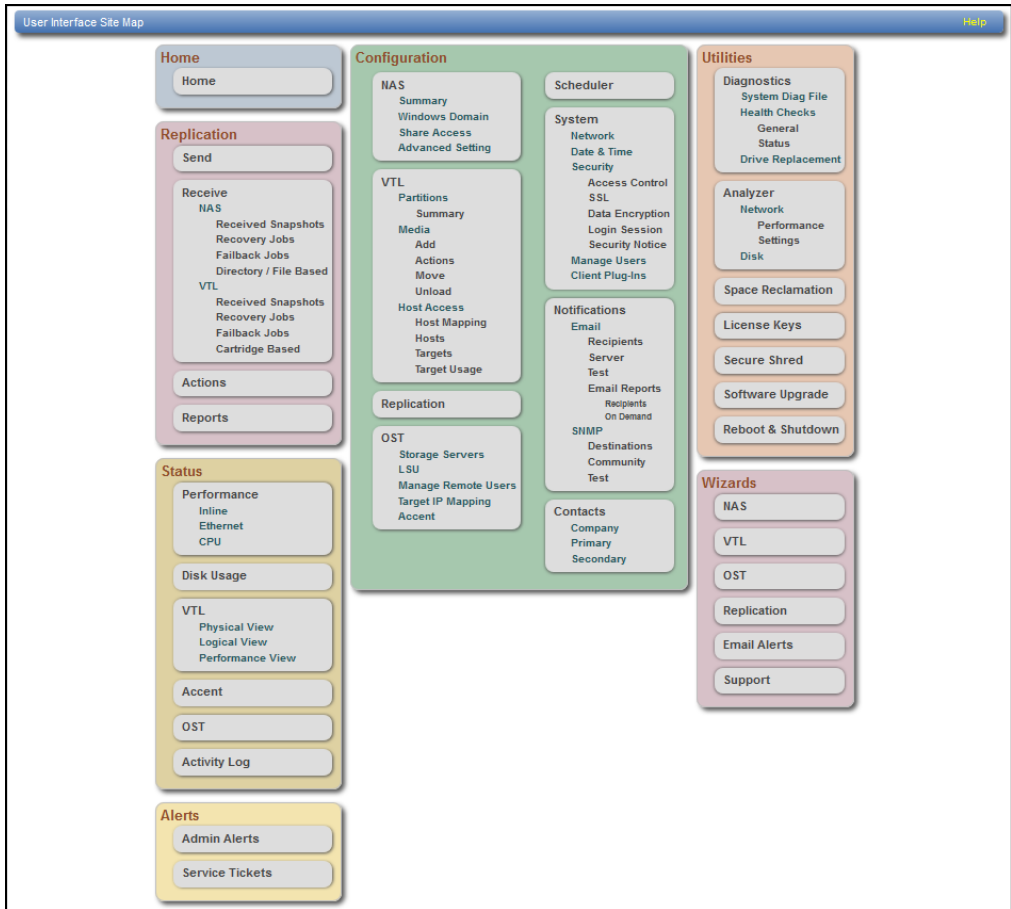



# Chapter 4: Configuration Wizards

---

This chapter contains the following topics:

Configuration Wizards .....	79
NAS Wizard (DXi6900) .....	81
NAS Wizard (DXi6900-S) .....	87
VTL Wizard .....	94
OST Wizard .....	102
Replication Wizard .....	108
Email Alerts Wizard .....	115
Support Wizard .....	120

---

## Configuration Wizards

The **Configuration Wizards** provide guided assistance for setting up the DXi6900. Use the wizards to quickly configure the most important features of the system, including storage presentation and data replication. Each wizard leads you step-by-step through the configuration process.

The **Configuration Wizards** page displays the first time you log on to the remote management console after completing the **Getting Started** wizard. After that, to access the **Configuration Wizards**, click **Wizards** on the main menu. This replaces the main menu with the **Wizards** menu (see [Figure 39 on page 81](#)).

The **Wizards** menu includes the following wizards:

Wizard	Description
<b>NAS</b>	<p>(DXi6900) Helps you configure the DXi6900 as a NAS (Network Attached Storage) appliance for use on a Windows or UNIX/Linux network (see <a href="#">NAS Wizard (DXi6900) on the next page</a>).</p> <p>(DXi6900-S) Helps you configure the DXi6900 as a NAS (Network Attached Storage) appliance for use with Oracle Recovery Manager (RMAN), on a Windows network, or on a UNIX/Linux network. (see <a href="#">NAS Wizard (DXi6900-S) on page 87</a>).</p>
<b>VTL</b>	Helps you configure the DXi6900 to present its storage as one or more VTL (Virtual Tape Library) partitions for use with a backup application (see <a href="#">VTL Wizard on page 94</a> ).
<b>OST</b>	Helps you configure the DXi6900 to present its storage as one or more OST (OpenStorage) storage servers for use with a backup application (see <a href="#">OST Wizard on page 102</a> ).
<b>Replication</b>	Helps you configure the DXi6900 to send replicated data to or receive replicated data from another DXi system (see <a href="#">Replication Wizard on page 108</a> ).
<b>Email Alerts</b>	<p>Helps you configure the DXi6900 to automatically send notifications and reports to selected recipients (see <a href="#">Email Alerts Wizard on page 115</a>).</p> <p><b>i Note:</b> Before exiting the <b>Wizards</b> menu, Quantum recommends configuring an e-mail server and enabling automatic e-mails. To help maintain system integrity, Quantum regularly collects system information through automatic e-mails. These e-mails contain configuration and status information only, and do not contain any customer data stored on the system</p>
<b>Support</b>	Helps you enable licensed features on the DXi6900, register your system with Quantum, and perform other tasks that will aid Quantum customer support in assisting you (see <a href="#">Support Wizard on page 120</a> ).

Click an item on the **Wizards** menu to begin a wizard. After you complete a wizard, a green check mark displays next to its name on the **Wizards** menu. To display the main menu again, click **Exit**.



Figure 39: Wizards Menu

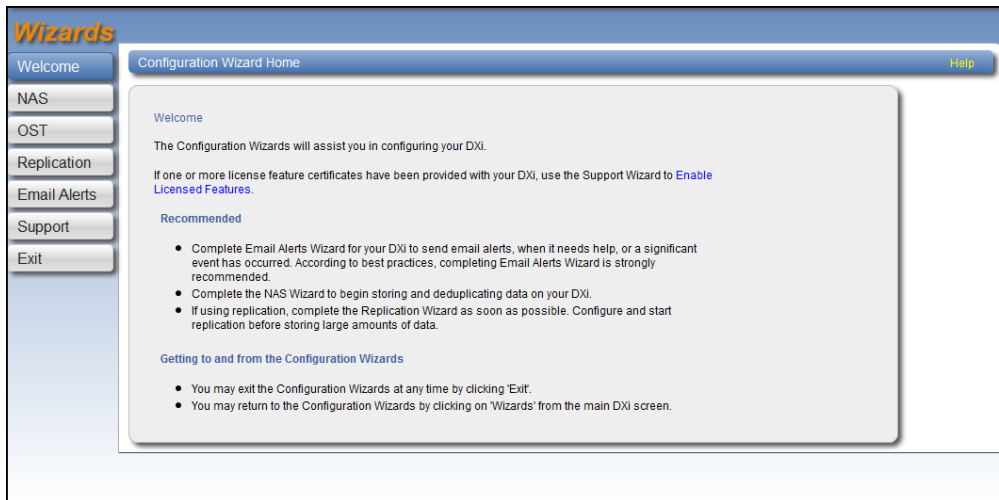

---

## NAS Wizard (DXi6900)

The **NAS** wizard provides guided assistance for configuring the DXi6900 as a NAS (Network Attached Storage) appliance. The wizard helps you determine if the NAS shares will be used on a Windows or UNIX/Linux network, and if necessary helps you join the DXi6900 to a Windows domain. Then the wizard guides you through the process of adding one or more NAS shares to receive backup data.

**i Note:** You cannot use the NAS wizard to edit existing shares. For more information about working with NAS shares, see [NAS Configuration on page 215](#).

To begin the **NAS** wizard, on the **Wizards** menu, click **NAS**.

### Step 1: About

1. Read the information about the wizard (see [Figure 40 on the next page](#)).
2. Click **Next** to continue.

**i Note:** At any time while using the wizard, you can click **Previous** to return to the previous step.

Figure 40: NAS Wizard: About

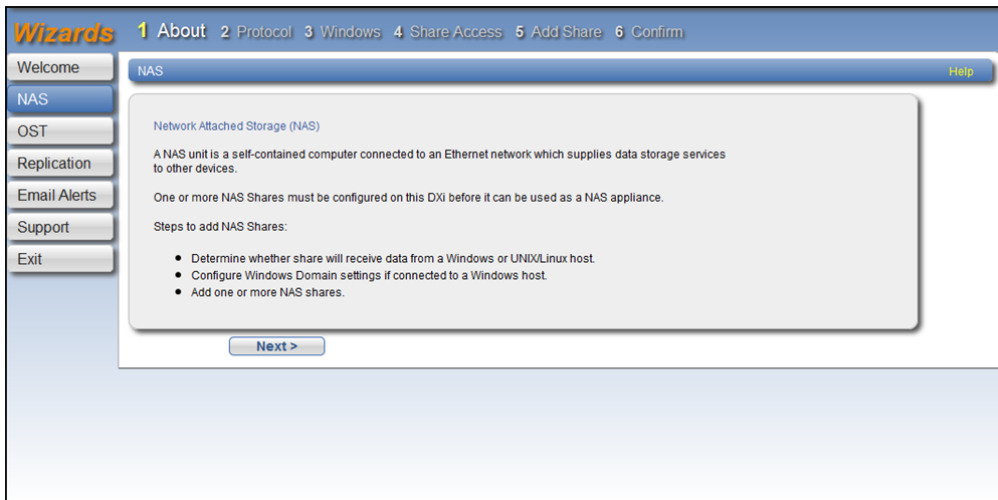

## Step 2: Protocol

1. Select the type of host the DXi6900 will present NAS shares to (see [Figure 41 below](#)):
  - **Windows (CIFS)** - All hosts that will interact with the DXi6900 run Windows.
  - **UNIX/Linux (NFS)** - All hosts that will interact with the DXi6900 run UNIX or Linux.
  - **Both Windows & UNIX/Linux** - Both types of hosts (Windows and UNIX/Linux) will interact with the DXi6900.
2. Click **Next** to continue.

Figure 41: NAS Wizard: Protocol

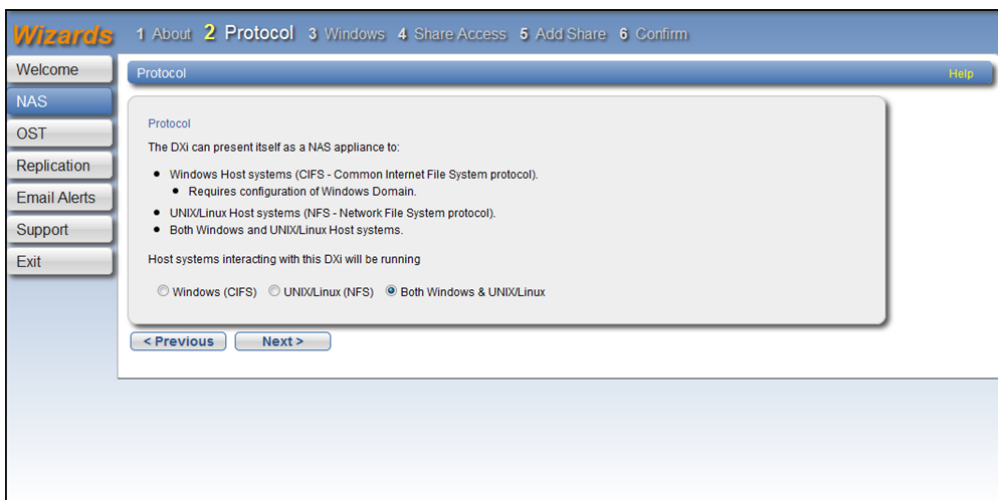

## Step 3: Windows

**i Note:** If you selected the **UNIX/Linux (NFS)** option in the previous step, the wizard automatically skips this step and the next step. Continue with [Step 5: Add Share on page 85](#).

1. Select an option for joining the DXi6900 to the Windows network (see [Figure 42 on the next page](#)):
  - **Active Directory** - Add the DXi6900 to a Windows network using Active Directory
  - **Workgroup** - Add the DXi6900 to a workgroup on a Windows network

**i Note:** To disjoin a domain, see [Windows Domain on page 223](#).

2. In the **Domain/Workgroup Name** box, enter the name of the domain or workgroup the DXi6900 is joining.
3. (Active Directory only) Enter information about the primary domain controller:

PDC Information	Description
<b>Primary Domain Controller</b>	Select an option for the Primary Domain Controller (PDC): <ul style="list-style-type: none"><li>• <b>Use DNS Discovery</b> - Discover the PDC automatically.</li><li>• <b>Specify Address</b> - Enter the fully qualified name or the IP address of the PDC.</li></ul>
<b>Organization Unit</b>	(Optional) Enter the name of the organizational unit in the domain. The DXi6900 will become a member of this organization
<b>Administrator Name</b>	Enter <b>Administrator</b> or any user that has the right to join the domain. By default, any user belonging to the <b>Administrators</b> group or the <b>Domain Admins</b> group has the right to join the domain. In addition, any user can join the domain if they are specifically delegated this right by a member of the <b>Administrators</b> group.
<b>Administrator Password</b>	Enter the password for the user entered above.

**i Note:** To configure users, see [Share Access on page 225](#).

4. Click **Next** to continue.

Figure 42: NAS Wizard: Windows

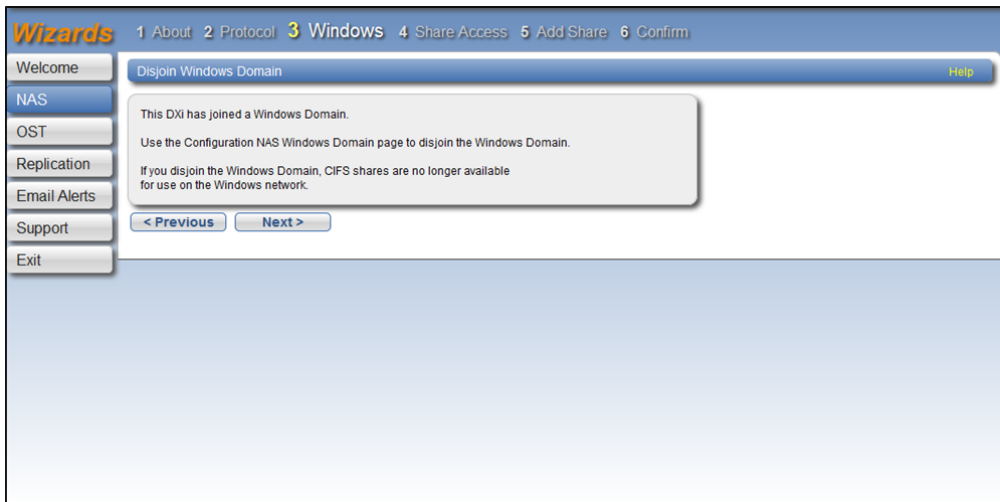

## Step 4: Share Access

**Note:** For more information about Workgroup users and Active Directory share administrators, see [Share Access on page 225](#).

1. Do one of the following depending on whether the DXi6900 is joining a Windows Workgroup or an Active Directory Domain (see [Figure 43 on the next page](#)):

### Windows Workgroup

Enter information about the workgroup user:

<b>User Name</b>	Enter the name of the workgroup user.
<b>Password</b>	Enter the password for the workgroup user.
<b>Confirm Password</b>	Enter the password again to confirm it.
<b>Description</b>	(Optional) Enter a brief description of the workgroup user.
<b>Grant Administrator Privileges</b>	Select the check box to add the workgroup user to the Windows Administrators group.  This allows the workgroup user to override certain permissions settings and prevents the workgroup user from being locked out of shares or directories.

### Active Directory Domain

Enter information about the share administrator.

---

<b>Fully Qualified User or Group Name</b>	Enter the administrator's user or group name.
---	---

---

2. Click **Add**.
3. (Optional) To add additional workgroup users or share administrators, repeat Steps 1–2.
4. Click **Next** to continue.

**Figure 43:** NAS Wizard: Share Access

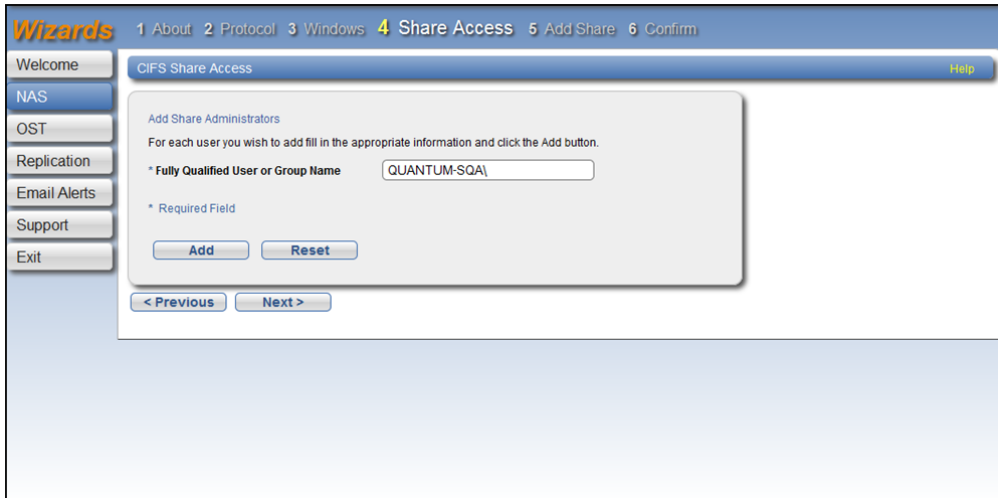

## Step 5: Add Share

1. Under **Add Share**, enter information about the NAS share (see [Figure 44 on the next page](#)):

---

<b>Name</b>	Enter the name of the NAS share.
<b>Description</b>	(Optional) Enter a brief description of the share.
<b>Enable deduplication</b>	Select the check box to enable data deduplication. Quantum recommends that you enable data deduplication to optimize disk usage. <b>i Note:</b> Data deduplication is enabled by default. You cannot enable or disable data deduplication after the share is added.
<b>Hide from network browsing</b>	(Windows shares only) Select the check box to hide the share from network browsing. If selected, you cannot see the share when browsing the network.

---

### Export Protocol

(Available only if you selected the Both option in Step 2: Protocol)  
Select the export protocol for the share:

- **CIFS** - Select the CIFS option to use the share on a Windows network.
- **NFS** - Select the NFS option to use the share on a UNIX or Linux network.

2. Click **Add**.
3. (Optional) To add additional shares, repeat Steps 1–2.
4. Click **Next** to continue.

Figure 44: NAS Wizard: Add Share

The screenshot shows the 'Add Share' step of the NAS Wizard. The interface includes a sidebar with navigation options (Welcome, NAS, OST, Replication, Email Alerts, Support, Exit) and a main content area titled 'Add Shares'. The 'Add Share' form includes fields for Name and Description, checkboxes for 'Enable deduplication' and 'Hide from network browsing', and radio buttons for 'Export Protocol' (CIFS (Windows network) and NFS (UNIX/Linux network)). There are 'Add' and 'Reset' buttons at the bottom of the form, and '< Previous' and 'Next >' navigation buttons below the form.

## Step 6: Confirm

1. Review the settings you selected to make sure they are correct (see [Figure 45 on the next page](#)). If necessary, click **Previous** to return to a previous step to make changes.
2. To make changes to a NAS share you added, first select the share and click **Delete** to delete the share. Then click **Previous** to return to the previous step and add a new share.
3. After you have confirmed all settings, click **Finish**. The wizard configures the DXi6900 with the settings you selected.

Figure 45: NAS Wizard: Confirm

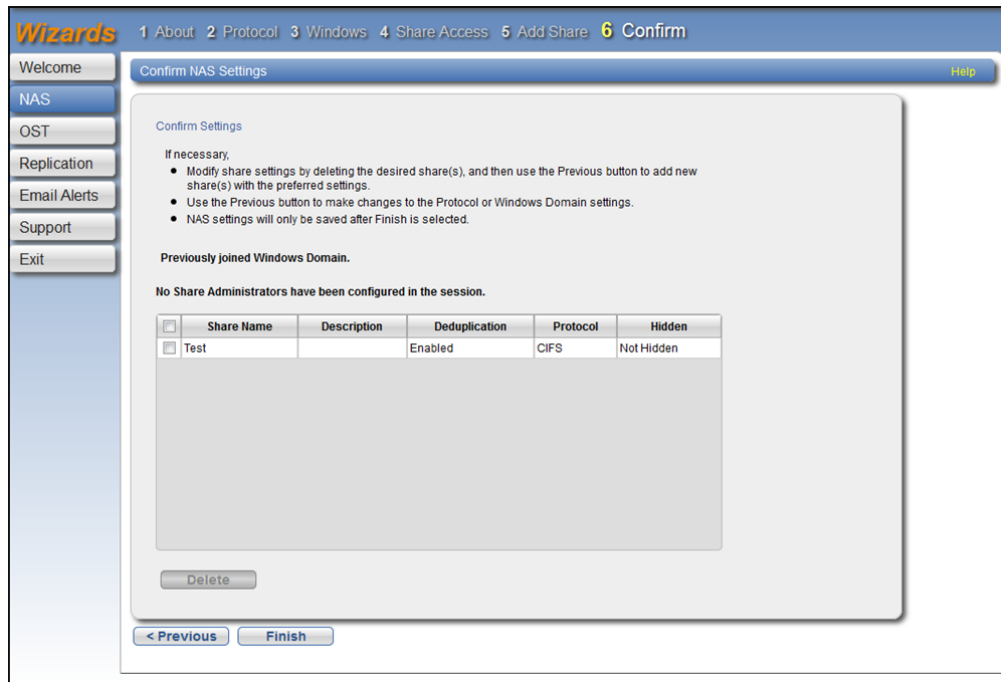

## NAS Wizard (DXi6900-S)

The **NAS** wizard provides guided assistance for configuring the DXi6900 as a NAS (Network Attached Storage) appliance. The wizard helps you determine if the NAS shares will be used on a Windows, UNIX/Linux network, with an Application Specific protocol, and if necessary helps you join the DXi6900 to a Windows domain. Then the wizard guides you through the process of adding one or more NAS shares to receive backup data.

**Note:** You cannot use the NAS wizard to edit existing shares. For more information about working with NAS shares, see [NAS Configuration on page 215](#).

To begin the **NAS** wizard, on the **Wizards** menu, click **NAS**.

### Step 1: About

1. Read the information about the wizard (see [Figure 46 on the next page](#)).
2. Click **Next** to continue.

**Note:** At any time while using the wizard, you can click **Previous** to return to the previous step.

Figure 46: NAS Wizard: About

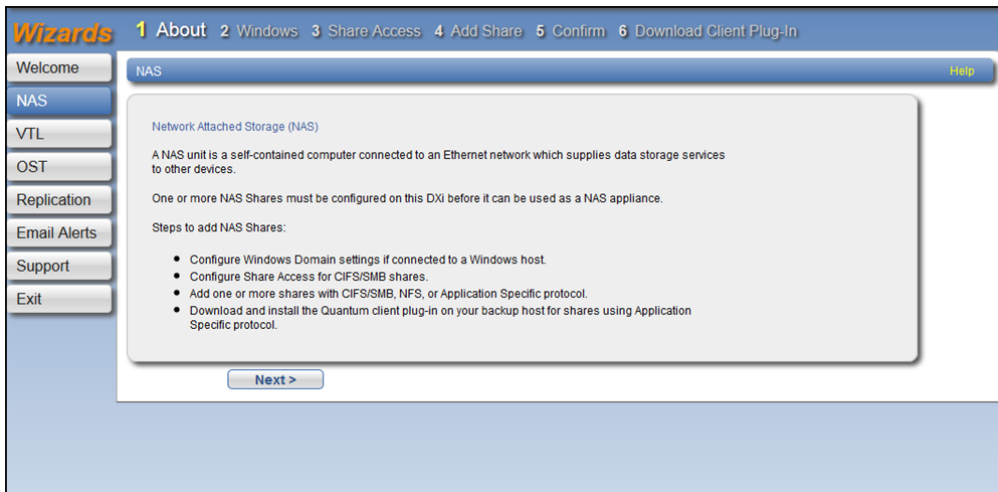

## Step 2: Windows

1. Select an option for joining the DXi6900 to the Windows network (see [Figure 47 on the next page](#)):
  - **Active Directory** - Add the DXi6900 to a Windows network using Active Directory
  - **Workgroup** - Add the DXi6900 to a workgroup on a Windows network

**Note:** To disjoin a domain, see [Windows Domain on page 223](#).

2. In the **Domain/Workgroup Name** box, enter the name of the domain or workgroup the DXi6900 is joining.
3. (Active Directory only) Enter information about the primary domain controller:

PDC Information	Description
<b>Primary Domain Controller</b>	Select an option for the Primary Domain Controller (PDC): <ul style="list-style-type: none"><li>• <b>Use DNS Discovery</b> - Discover the PDC automatically.</li><li>• <b>Specify Address</b> - Enter the fully qualified name or the IP address of the PDC.</li></ul>
<b>Organization Unit</b>	(Optional) Enter the name of the organizational unit in the domain. The DXi6900 will become a member of this organization



PDC Information	Description
<b>Administrator Name</b>	Enter <b>Administrator</b> or any user that has the right to join the domain.  By default, any user belonging to the <b>Administrators</b> group or the <b>Domain Admins</b> group has the right to join the domain. In addition, any user can join the domain if they are specifically delegated this right by a member of the <b>Administrators</b> group.
<b>Administrator Password</b>	Enter the password for the user entered above.

**Note:** To configure users, see [Share Access on page 225](#).

4. Click **Next** to continue.

Figure 47: NAS Wizard: Windows

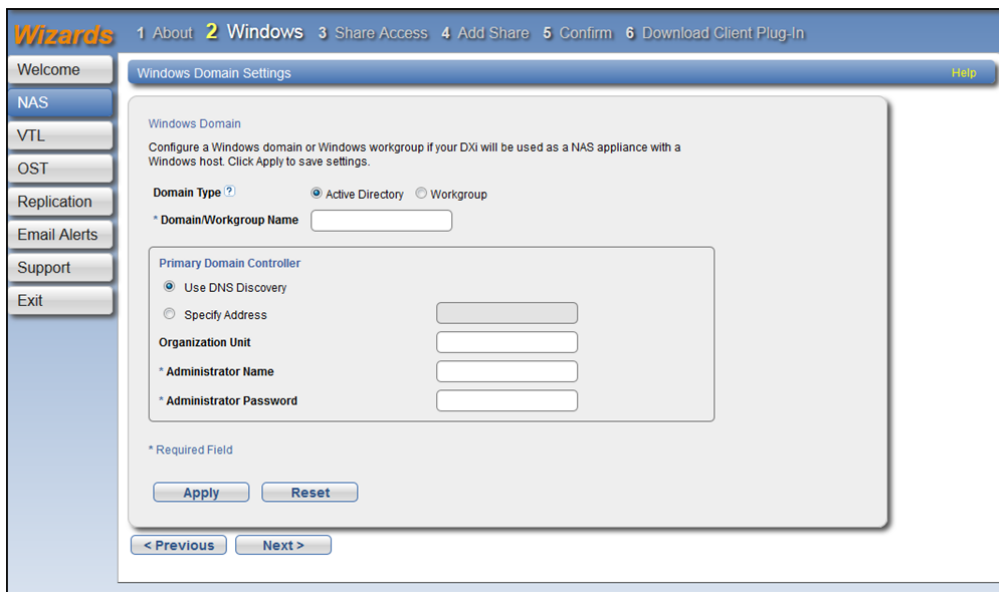

## Step 3: Share Access

**Note:** For more information about Workgroup users and Active Directory share administrators, see [Share Access on page 225](#).

1. Do one of the following depending on whether the DXi6900 is joining a Windows Workgroup or an Active Directory Domain (see [Figure 48 on the next page](#)):

### Windows Workgroup

Enter information about the workgroup user:

<b>User Name</b>	Enter the name of the workgroup user.
<b>Password</b>	Enter the password for the workgroup user.
<b>Confirm Password</b>	Enter the password again to confirm it.
<b>Description</b>	(Optional) Enter a brief description of the workgroup user.
<b>Grant Administrator Privileges</b>	Select the check box to add the workgroup user to the Windows Administrators group.  This allows the workgroup user to override certain permissions settings and prevents the workgroup user from being locked out of shares or directories.

### Active Directory Domain

Enter information about the share administrator.

<b>Fully Qualified User or Group Name</b>	Enter the administrator's user or group name.
---	---



2. Click **Add**.
3. (Optional) To add additional workgroup users or share administrators, repeat Steps 1–2.
4. Click **Next** to continue.

Figure 48: NAS Wizard: Share Access



## Step 4: Add Share

1. Under **Add Share**, enter information about the NAS share (see [Figure 49 on page 92](#)):

<b>Name</b>	Enter the name of the NAS share.
<b>Description</b>	(Optional) Enter a brief description of the share.
<b>Protocol</b>	Select the export protocol for the share: <ul style="list-style-type: none"><li>• <b>CIFS/SMB</b> - Select the CIFS/SMB option to use the share on a Windows network.</li><li>• <b>NFS</b> - Select the NFS option to use the share on a UNIX or Linux network.</li><li>• <b>Application Specific</b> - Select the Application Specific option to create an Oracle RMAN share.</li></ul>
<b>Enable deduplication</b>	(CIFS/SMB/NFS shares only) Select the check box to enable data deduplication. Quantum recommends that you enable data deduplication to optimize disk usage.  <b>Note:</b> Data deduplication is enabled by default. You cannot enable or disable data deduplication after the share is added.  <b>Note:</b> Deduplication of Application Specific shares is enabled by default.
<b>Hide from network browsing</b>	(CIFS/SMB shares only) Select the check box to hide the share from network browsing. If selected, you cannot see the share when browsing the network.

2. Click **Add**.
3. (Optional) To add additional shares, repeat Steps 1–2.
4. Click **Next** to continue.

Figure 49: NAS Wizard: Add Share

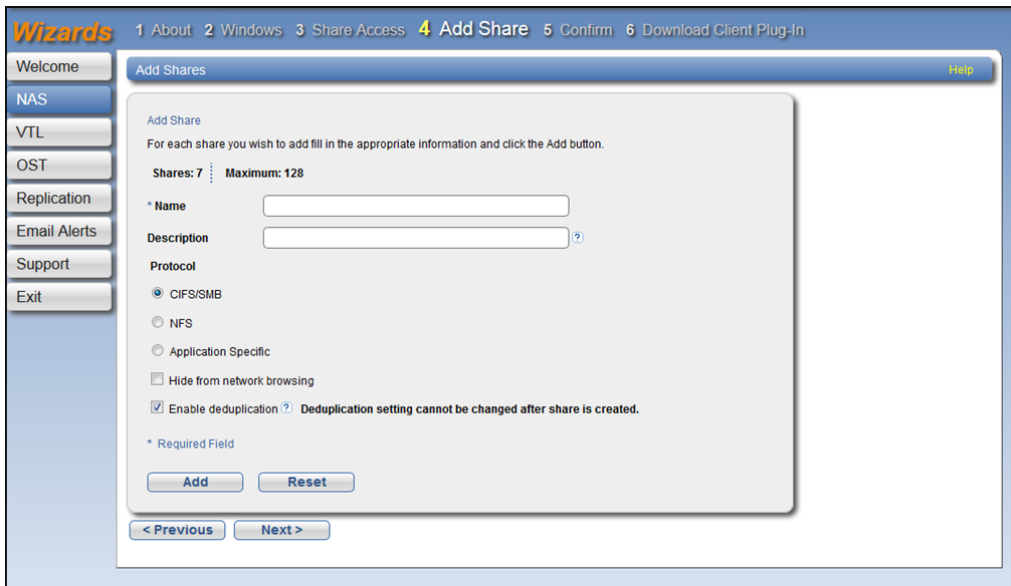

## Step 5: Confirm

1. Review the settings you selected to make sure they are correct (see [Figure 50 on the next page](#)). If necessary, click **Previous** to return to a previous step to make changes.
2. To make changes to a NAS share you added, first select the share and click **Delete** to delete the share. Then click **Previous** to return to the previous step and add a new share.
3. After you have confirmed all settings, click **Finish**. The wizard configures the DXi6900 with the settings you selected.

Figure 50: NAS Wizard: Confirm

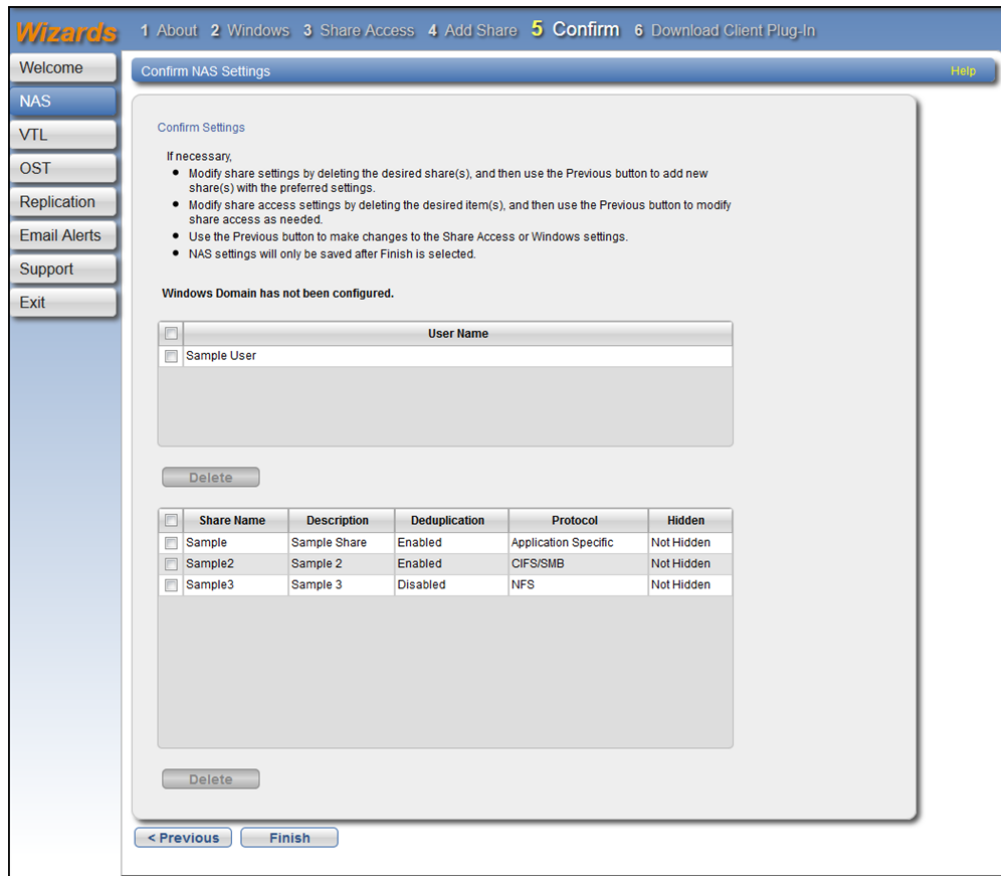

## Step 6: Download Client Plug-in

To download the Application Specific (RMAN) Plug-in, click **Client Plug-in Download** (see [Figure 51 on the next page](#)). On the download page, download the correct RMAN Plug-in for your backup application and operating system.

Also on the download page, click **Installation Instructions** to download the *RMAN Plug-in Installation Instructions*. Follow the instructions to install the RMAN Plug-in on your Oracle server.

Figure 51: NAS Wizard: Download Client Plug-in

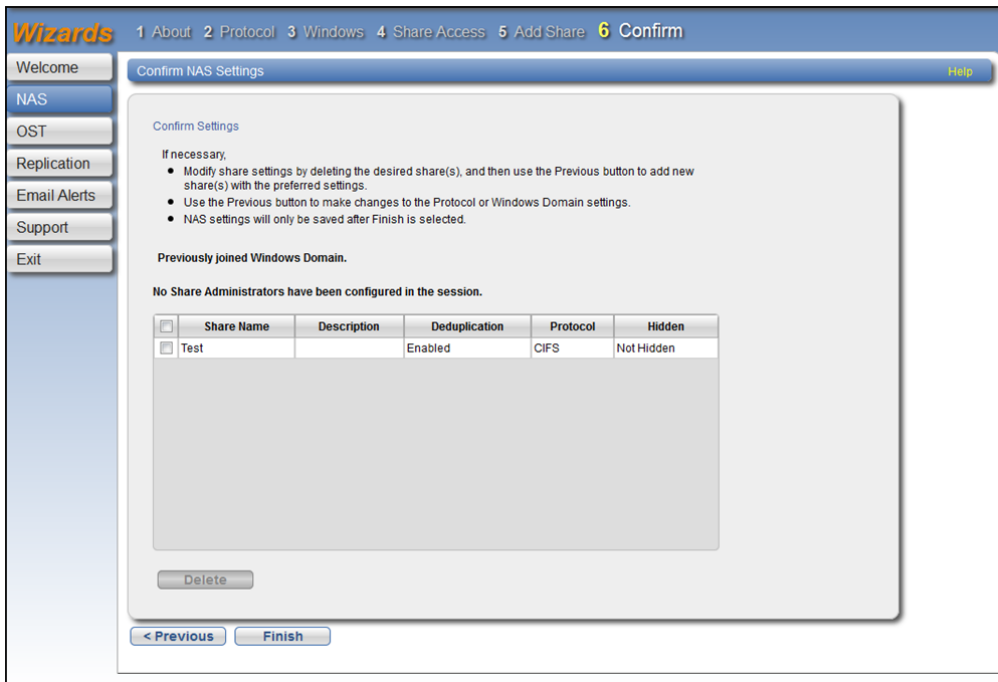

## VTL Wizard

The **VTL** wizard provides guided assistance for configuring the DXi6900 to present its storage as one or more VTL (Virtual Tape Library) partitions for use with a backup application. The wizard guides you through the process of adding one or more VTL partitions, adding virtual media, discovering hosts, and mapping partitions to hosts.

**Note:** You cannot use the **VTL** wizard to edit or add media to existing partitions, or to edit existing host access groups. For more information about working with VTL partitions, see [VTL Configuration on page 231](#).

To begin the **VTL** wizard, on the **Wizards** menu, click **VTL**.

### Step 1: About

1. Read the information about the wizard (see [Figure 52 on the next page](#)).
2. Click **Next** to continue.

**Note:** At any time while using the wizard, you can click **Previous** to return to the previous step.

Figure 52: VTL Wizard: About

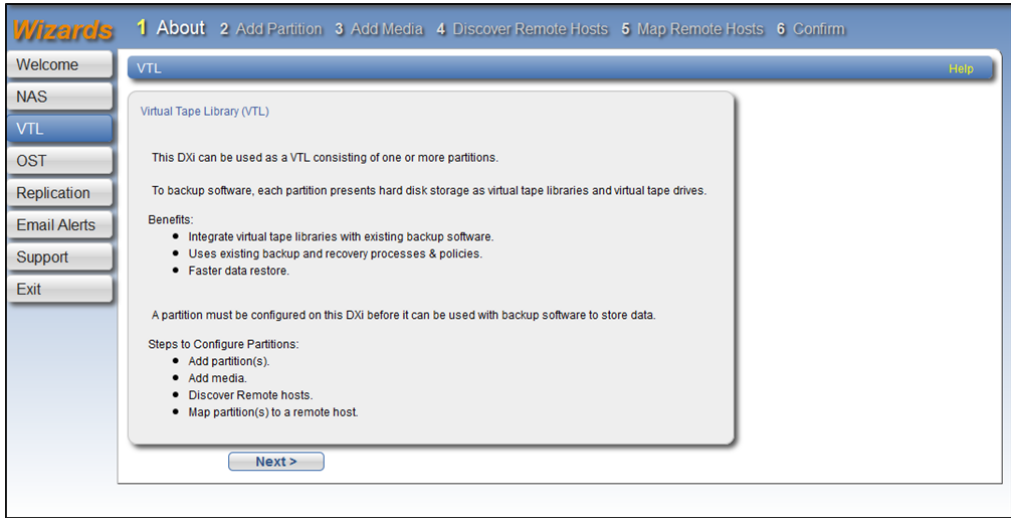

## Step 2: Add Partition

1. Under **Partition Settings**, enter information about the partition (see [Figure 53 on page 97](#)):

Partition Setting	Description
Name	Enter the name of the VTL partition.

Partition Setting	Description
<b>Library Model</b>	<p>Select the library model emulated by the partition. The library model determines the inquiry string returned to the host by the DXi6900.</p> <p><b>The following library models are available:</b></p> <ul style="list-style-type: none"><li>• Quantum DXi7500</li><li>• ADIC Scalar 100, ADIC Scalar i2000, or ADIC Scalar i500</li><li>• ADIC Pathlight VX</li><li>• Quantum Scalar i40/i80 or Quantum Scalar i6000</li><li>• Quantum DXi6700, Quantum DXi6900, Quantum DXi6800, Quantum DXi4700, Quantum DXi4601, QuantumDXi4500, or Quantum DXi8500</li><li>• Quantum DX3000 or Quantum DX5000</li><li>• Quantum PX500 or Quantum PX720</li><li>• ATL M2500, ATL P1000, or ATL P7000</li></ul> <p>If you select a library such as the ATL P1000 or ATL P7000, the DXi6900 appears as the selected library to the host and backup application. If you select Quantum DXi6900, the host and backup application recognize the device as a Quantum DXi6900.</p> <p><b>i Note:</b> Quantum recommends that you set the library model to Quantum DXi6900 for best compatibility. If your backup application does not support the Quantum Quantum DXi6900 inquiry string, select a different library model. Check your software compatibility guide to verify what library models are supported.</p>
<b>Number of Storage Slots</b>	<p>Accept the default number of storage slots(based on model), or enter the number of storage slots in the partition (up to 9,000).</p> <p>One I/E slot is created for each storage slot up to a maximum of 240 I/E slots.</p>
<b>Virtual Tape Drive Model</b>	<p>Select the tape drive model emulated by the virtual drives in the partition. All virtual tape drives in a partition must be the same model.</p> <p><b>The following tape drive models are available:</b></p> <ul style="list-style-type: none"><li>• Quantum DLT-S4, SDLT600, SDLT320, or DLT7000</li><li>• Certance LTO-2 and LTO-3</li><li>• IBM LTO-1, LTO-2, LTO-3, LTO-4, or LTO-5</li><li>• HP LTO-1, LTO-2, LTO-3, LTO-4, or LTO-5</li></ul>



Partition Setting	Description
<b>Number of Virtual Tape Drives</b>	<p>Accept the default number of tape drives (based on model), or enter the number of virtual tape drives in the partition.</p> <p><b>Note:</b> If all tape drives are currently assigned to other partitions, you must remove one or more tape drives from an existing partition to make them available for use in a new partition.</p>
<b>Enable deduplication</b>	<p>Select the check box to enable data deduplication. Quantum recommends that you enable data deduplication to optimize disk usage.</p> <p><b>Note:</b> Data deduplication is enabled by default. You cannot enable or disable data deduplication after the partition is added.</p>
<b>Enable Auto Export</b>	<p>Select the check box to enable auto export. When a tape is exported by the backup application, it is placed in a virtual I/E slot. After this, one of the following actions occurs:</p> <ul style="list-style-type: none"> <li>(Default) If Auto Export is enabled, the media is removed from the virtual I/E slot.</li> <li>If Auto Export is disabled, the media remains in the virtual I/E slot.</li> </ul>

2. Click **Add**.
3. (Optional) To add additional partitions, repeat Steps 1–2.
4. Click **Next** to continue.

**Figure 53:** VTL Wizard: Add Partition

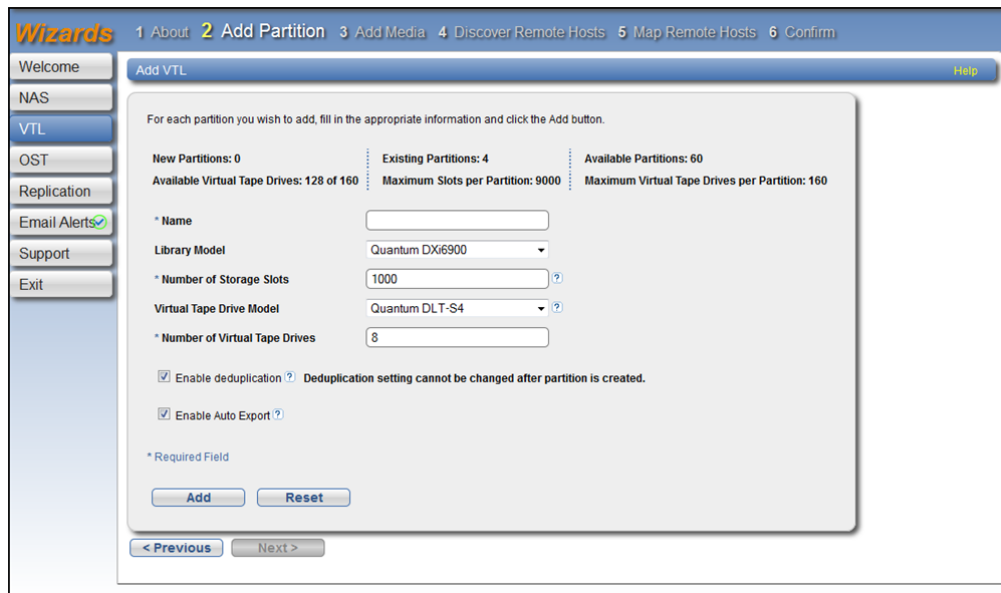

## Step 3: Add Media

1. In the **Partition** drop-down box, select the partition where the media will be created (see [Figure 54 on the next page](#)).
2. Under **Add Contiguous Media**, enter information about the media:

Media Setting	Description
<b>Initial Location</b>	The initial location for cartridges after they are created ( <b>Storage Slot</b> or <b>I/E Slot</b> ). <b>i Note:</b> You cannot create more cartridges than the number of available slots in the initial location. For example, if 50 I/E slots are available, you cannot create more than 50 cartridges if the initial location is set to <b>I/E Slot</b> .
<b>Number of Media</b>	The number of cartridges to create in the partition.
<b>Starting Barcode</b>	The first barcode number in the cartridge sequence. You can enter any alpha-numeric string for the starting barcode. Subsequent barcodes are incremented accordingly. For example, if you enter AA, the cartridges are numbered AA0000, AA0001, AA0002, and so on. If you enter a starting barcode with less than 6 characters, zeroes are appended to the barcode to make it 6 characters long.
<b>Media Type</b>	The media type of the cartridges. <b>i Note:</b> The available media type options are determined by the type of tape drive selected when the partition was created (see <a href="#">Adding a VTL Partition on page 233</a> ).
<b>Media Capacity</b>	The capacity of the cartridges. Select an option: <ul style="list-style-type: none"><li>• <b>Native Size</b> - The capacity is determined by the selected media type.</li><li>• <b>Custom Size</b> - The capacity is a custom value. Enter the custom cartridge capacity in the box. Make sure the value is within the acceptable range displayed next to the box.</li></ul>

3. Click **Add**.
4. (Optional) To add additional media, repeat Steps 1–3.
5. Click **Next** to continue.

Figure 54: VTL Wizard: Add Media

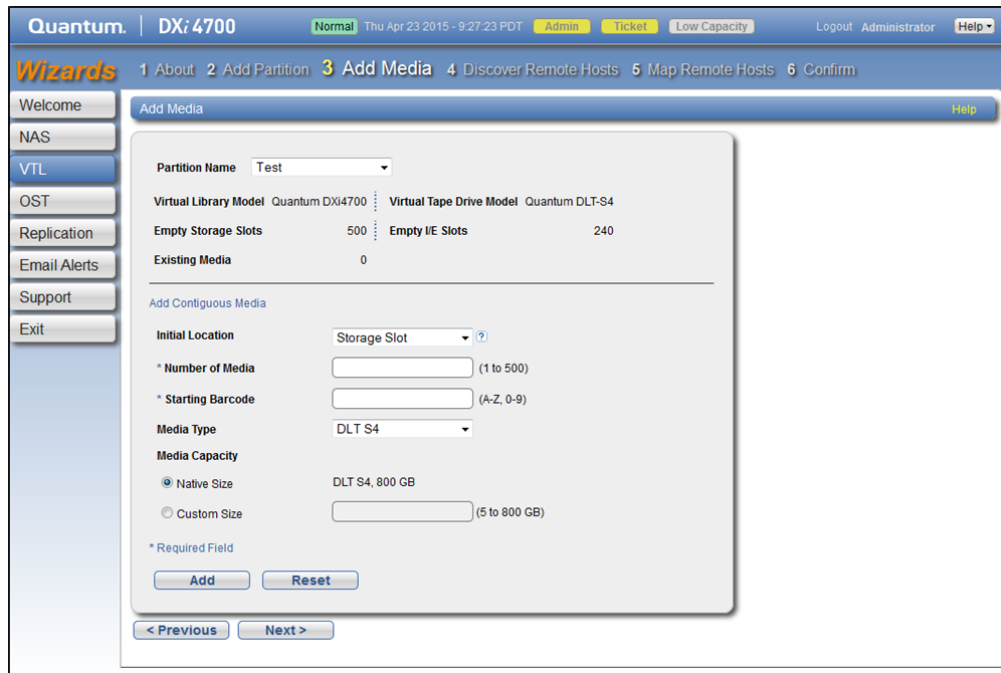

## Step 4: Discover Remote Hosts

1. Click **Discover Remote Hosts** to list all hosts that are known to the DXi6900 (see [Figure 55 on the next page](#)).

A host is made known to the DXi6900 if you enter the host ID on this page, or if the host logs on to one or more Fibre Channel target ports.

If you do not see the world wide name (WWN) of the host, make sure the host is connected to a Fibre Channel port on the DXi6900 and click **Discover Remote Hosts** again.

The **Backpanel Locations** section displays a graphical representation of the Fibre Channel and Ethernet ports as they appear on the rear of the system.

**Note:** An **Active** status indicates the host is currently logged on to one or more Fibre Channel target ports.

2. Enter information about the host:

Host Information	Description
<b>Remote Host WWPN</b>	Enter the World Wide Port Name (WWPN) of the host.
<b>Alias</b>	Enter a descriptive alias for the host

3. Click **Apply**.

- (Optional) To discover additional hosts, repeat Steps 1–3.
- Click **Next** to continue.

**Figure 55:** VTL Wizard: Discover Remote Hosts

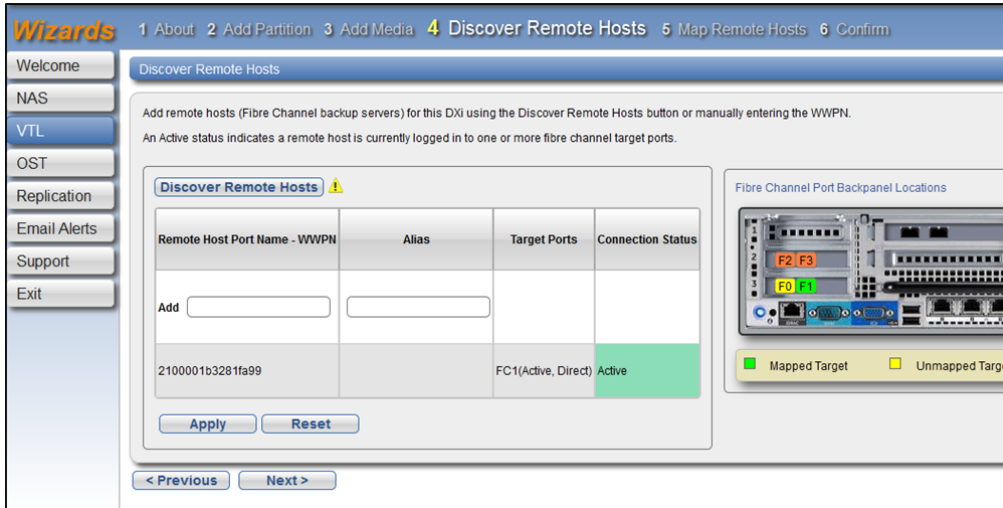

## Step 5: Map Remote Hosts

- Enter information about the host access group (see [Figure 56 on the next page](#)):

Host Access Information	Description
<b>Group Name</b>	Enter a name for the group.
<b>Partition</b>	Select the partition to associate with the group.
<b>Remote Host</b>	Select the host (initiator) to associate with the group.
<b>Target</b>	Select the target (port) to associate with the group.

**Note:** The **Backpanel Locations** section displays a graphical representation of the Fibre Channel and Ethernet ports as they appear on the rear of the system. A dark border displays around the currently selected target.

To change the LUN numbers assigned to a device, or to map virtual devices to a host, use the **Configuration > VTL > Host Access > Host Mapping** page (see [Remote Host Mapping on page 249](#)).

- (Optional) Select the **Use CCL** check box to use the Command and Control LUN.

**Note:** The CCL (Command and Control LUN) is not used in most environments. This option is recommended for host access groups that contain an HP-UX host. It can also be used if hosts that are not assigned to any host access group exist in the SAN. The CCL is accessible to hosts only through LUN 0.

**Caution:** If you are not sure if you should use CCL, contact Quantum Customer Support before you enable this option.

3. Click **Add**.
4. (Optional) To map additional hosts, repeat Steps 1–3.
5. Click **Next** to continue.

**Figure 56:** VTL Wizard: Map Remote Hosts

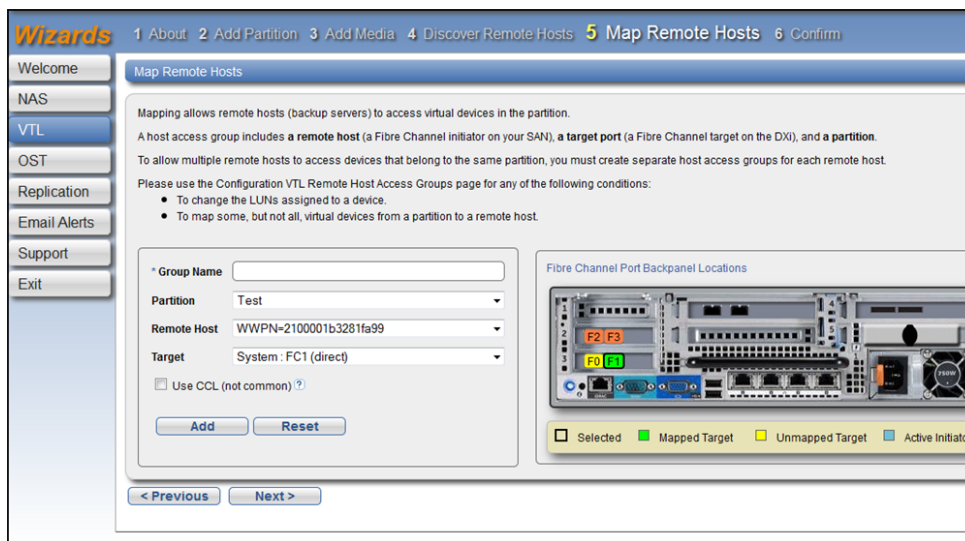

## Step 6: Confirm

1. Review the settings you selected to make sure they are correct (see [Figure 57 on the next page](#)). If necessary, click **Previous** to return to a previous step to make changes.
2. To make changes to a VTL partition, media, or host access group you added, first select the item and click **Delete** to delete it. Then click **Previous** to return to the appropriate step and add a new item.
3. After you have confirmed all settings, click **Finish**. The wizard configures the DXi6900 with the settings you selected.

Figure 57: VTL Wizard: Confirm

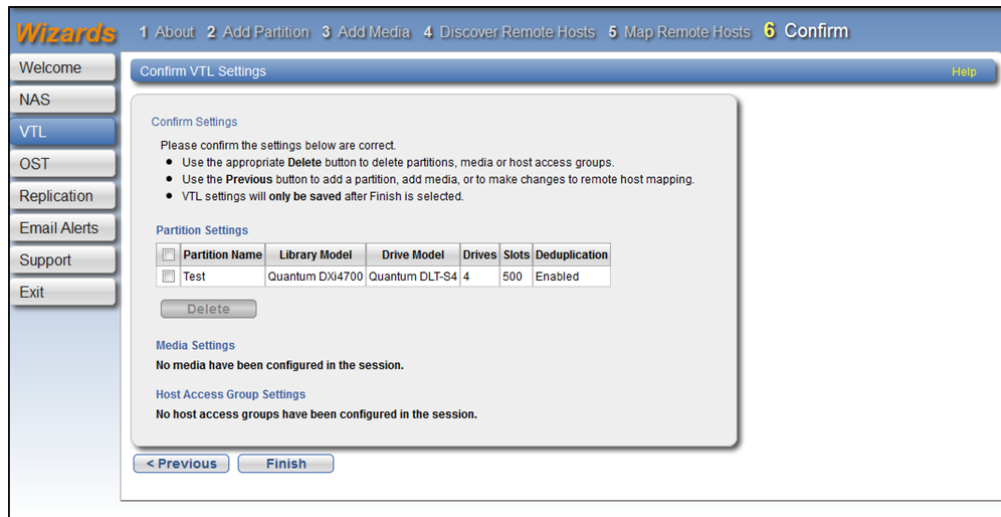

## OST Wizard

The **OST** wizard provides guided assistance for configuring the DXi6900 to present its storage as one or more OST (OpenStorage) storage servers for use with a backup application. The wizard guides you through the process of adding one or more OST storage servers, configuring LSUs (logical storage units), and adding OST users. The wizard also provides a link for downloading and installing the OST Plug-in on your backup host.

### Additional Information

- If you plan to use **Concurrent Optimized Duplication**, you should complete the Replication wizard before beginning the OST wizard (see [Replication Wizard on page 108](#)).
- You cannot use the OST wizard to edit existing storage servers or LSUs. For more information about working with OST, see [OST Configuration on page 257](#).
- OST options can only be configured when the **OST** license has been enabled (see [License Keys on page 377](#)).

To begin the **OST** wizard, on the **Wizards** menu, click **OST**.

### Step 1: About

1. Read the information about the wizard (see [Figure 58 on the next page](#)).

The **About** page displays the status of the OST service. OST settings can be configured in **Ready**, **Stopped**, or **Verifying** state. The OST server is available for backup only in **Ready** state.

2. Click **Next** to continue.

**Note:** At any time while using the wizard, you can click **Previous** to return to the previous step.

Figure 58: OST Wizard: About

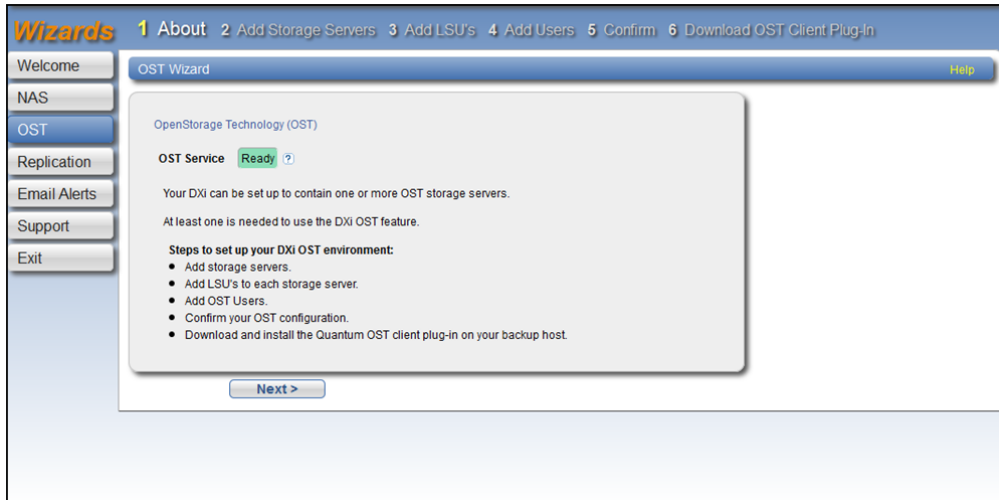

## Step 2: Add Storage Servers

1. Under **Add Storage Server**, enter information about the storage server (see [Figure 59 on the next page](#)):

Storage Server Information	Description
<b>Name</b>	Enter the name of the storage server. <b>Caution:</b> Do not use an underscore ( _ ) in the name of the storage server.
<b>Description</b>	(Optional) Enter a brief description of the storage server.
<b>Max Connections</b>	Enter the maximum number of connections allowed to the storage server (3 to 65536). <b>Note:</b> Quantum recommends setting <b>Max Connections</b> to 300.

Storage Server Information	Description
<b>Enable Concurrent Optimized Duplication</b>	<p>Select the check box to enable optimized duplication during OST ingest.</p> <p>Concurrent Optimized Duplication is disabled by default. If enabled, as data is written to the storage server, it is simultaneously replicated to the target DXi. When optimized duplication or Automatic Image Replication subsequently occurs, the operation is more efficient because a portion of the required data has already been replicated to the target storage server.</p> <ul style="list-style-type: none"><li><b>Note:</b> To configure the target DXi, see <a href="#">Replication Wizard on page 108</a>.</li><li><b>Note:</b> When Concurrent Optimized Duplication is enabled, all data on the storage server is duplicated, not just the specified images.</li></ul>

2. Select the check box for each optimized duplication target you want to duplicate the storage server to. When the storage server is duplicated, its data will be sent to all selected targets.
3. Click **Add**.  
The storage server displays in the **Storage Servers Added** table.
4. (Optional) To add additional storage servers, repeat Steps 1–2.  
To remove a storage server, select it in the **Storage Servers Added** table and click **Delete**.
5. Click **Next** to continue.

Figure 59: OST Wizard: Add Storage Servers

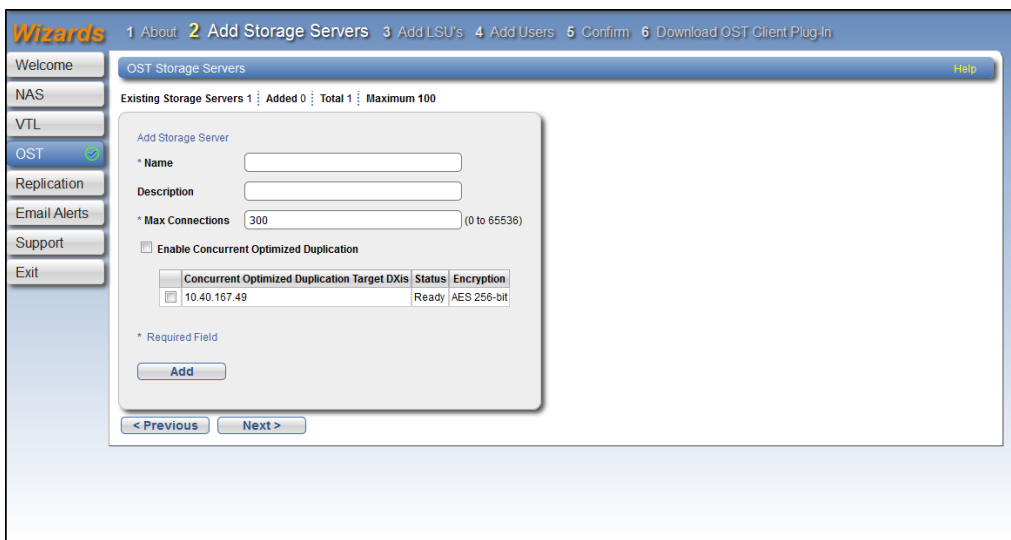



## Step 3: Add LSUs

1. Enter information about the LSU (see [Figure 60 on the next page](#)).

LSU Information	Description
<b>Storage Server</b>	Select the storage server that will contain the new LSU.
<b>Use Available Capacity</b>	<p>Select this option to add an LSU that uses the available capacity on the system.</p> <p>You cannot add an available capacity LSU to a storage server that already contains an LSU. Also, if you add an available capacity LSU to a storage server, you cannot add additional LSUs to that same storage server.</p> <p><b>i Note:</b> After you add an LSU that uses the <b>Available Capacity</b> option, you cannot change the LSU to use the <b>Specific Capacity</b> option. Instead, you must delete the LSU, then add a new LSU and choose the <b>Specific Capacity</b> option (see <a href="#">Deleting an LSU on page 272</a>).</p>
<b>Specify Capacity</b>	<p>Select this option to specify the physical capacity of the LSU, and then enter the following information.</p> <ul style="list-style-type: none"><li>• <b>LSU Name</b> - Enter the name of the LSU.</li><li>• <b>Physical Capacity</b> - Enter the physical capacity of the LSU (1 to 1048576 GB).</li></ul>

2. Click **Add**.

The LSU displays in the **LSUs Added** table.

3. (Optional) To add additional LSUs, repeat Steps 1–2.

To remove an LSU, select it in the **LSUs Added** table and click **Delete**.

4. Click **Next** to continue.

**i Note:** To configure the LSU for Automatic Image Replication, use the **Configuration > OST > LSU** page (see [LSU on page 266](#)).

Figure 60: OST Wizard: Add LSUs

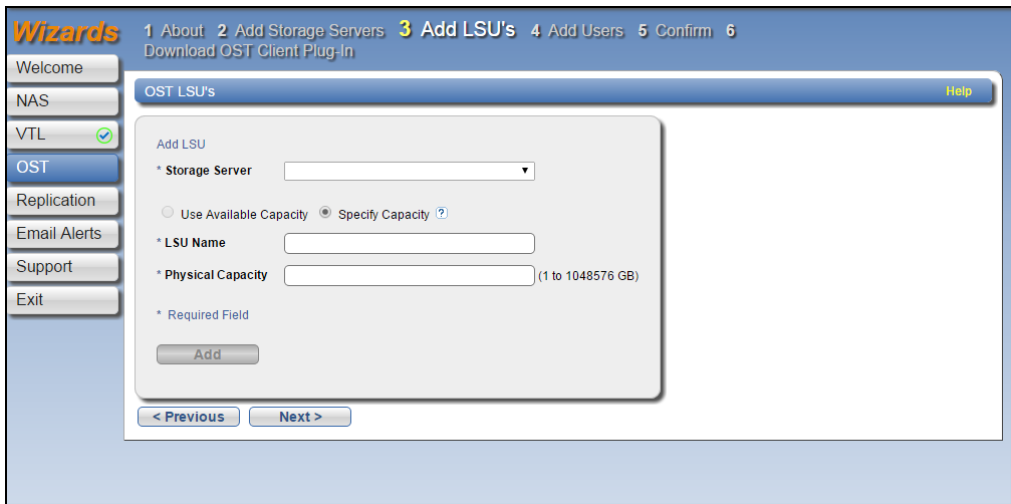

## Step 4: Add Users

1. Enter information about the authenticated user (see [Figure 61 on the next page](#)):

User Information	Description
<b>Username</b>	Enter the name of the authenticated user.
<b>Password</b>	Enter the password for the authenticated user.
<b>Confirm Password</b>	Enter the password again to confirm it.
<b>Description</b>	(Optional) Enter a brief description of the authenticated user.

2. Click **Apply**.  
The user displays in the **Users Added** table.
3. (Optional) To add additional users, click **Add** and then repeat Steps 1–2.  
To remove a user, select it in the **Users Added** table and click **Delete**.
4. Click **Next** to continue.

Figure 61: OST Wizard: Add Users

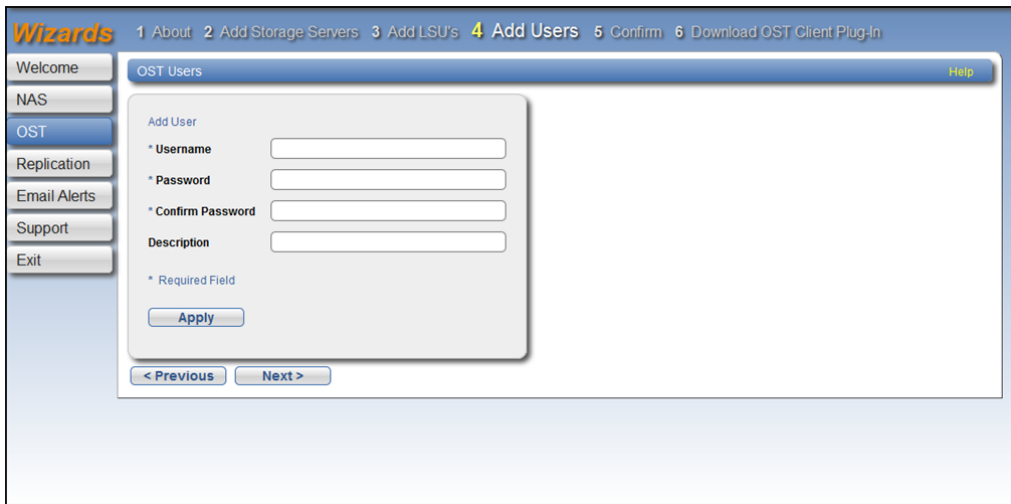

## Step 5: Confirm

1. Review the settings you selected to make sure they are correct (see [Figure 62 below](#)). The items to be added display in the **Storage Servers Added**, **LSUs Added**, and **Users Added** tables. If necessary, click **Previous** to return to a previous step to make changes.
2. To make changes to storage servers, LSUs, or users you added, click **Previous** to return to the appropriate step. Select the incorrect item and click **Delete** to remove it, and then add a new item.
3. After you have confirmed all settings, click **Finish**. The wizard configures the DXi6900 with the settings you selected.

Figure 62: OST Wizard: Confirm

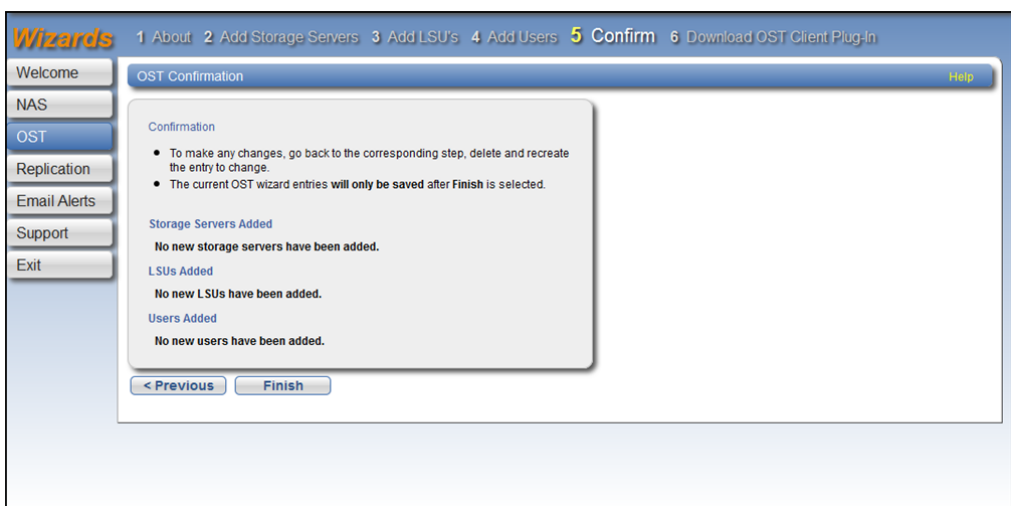

## Step 6: Download OST Client Plug-in

To download the OST Plug-in, click **Client Plug-in Download** (see [Figure 63 below](#)). On the download page, download the correct OST Plug-in for your backup application and operating system.

Also on the download page, click **Installation Instructions**, to download the *OST Plug-in Installation Instructions*. Follow the instructions to install the OST Plug-in on your media server.

**Figure 63:** OST Wizard: Download OST Client Plug-in

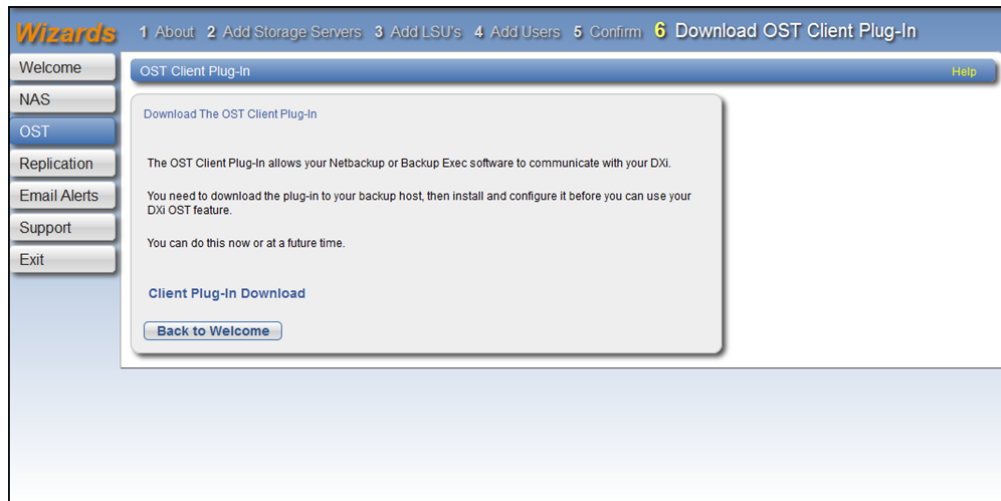

---

## Replication Wizard

The **Replication** wizard provides guided assistance for configuring the DXi6900 to send replicated data to another DXi system as part of disaster recovery plan. The wizard can also help you configure the DXi6900 to receive replicated data from another DXi system.

Sources *send* replicated data, and targets *receive* replicated data. A target system can receive data from up to 10 sources. However, a source system can replicate data up to two targets. Finally, one system can act as both a source and a target.

### Additional Information

- For more information about working with data replication, see [Replication on page 138](#).
- Use the **Replication** wizard (or the **Configuration > Replication** page) to configure other DXi systems that this DXi6900 is configured to send replicated data to or receive replicated data from. You should configure a target system before configuring source systems.

To begin the **Replication** wizard, on the **Wizards** menu, click **Replication**.

## Step 1: About

1. Read the information about the wizard.
2. Click **Next** to continue.

**i Note:** At any time while using the wizard, you can click **Previous** to return to the previous step (see [Figure 64 below](#)).

**Figure 64:** Replication Wizard: About

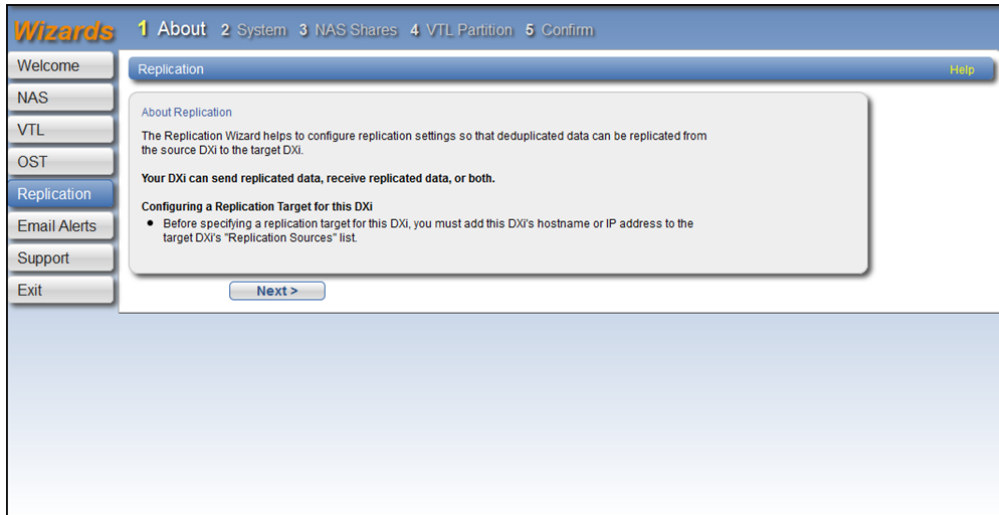

## Step 2: System

1. If data on this DXi6900 will be replicated to another DXi system, enter target information under **Target DXis** (see [Figure 65 on page 111](#)).

If two targets are already specified, you must delete a target before adding another. First click **Pause** to pause replication to the target, and then click **Delete** to remove the target.

Before specifying a target, make sure you have completed the **Replication** wizard on the target DXi. The target DXi must be configured to allow the source DXi hostname or IP address.

You can specify up to two targets:

- a. In the **Target Hostname or IP Address** box, enter the hostname or IP address of the system that will receive the replicated data.

When entering IP addresses, never use an address that is in a reserved IP address range. To see a list of reserved IP address ranges, click the quick tip icon **[?]** located near the IP address field.

To use hostname format, you must specify at least one DNS IP address on the **Network** page (see [Network on page 322](#)).

- b. (Optional) Select an encryption option:

Encryption Option	Description
<b>NONE</b>	Data is not encrypted when sending replication data to the target system.
<b>AES 128-BIT</b>	Data is encrypted using AES 128-bit encryption when sending replication data to the target system.
<b>AES 256 BIT</b>	Data is encrypted using AES 256-bit encryption when sending replication data to the target system.

 **Caution:** Select 128-bit encryption if you are sending data to a DXi running a system software version prior to DXi 2.1 Software.

 **Note:** AES encryption options are available only if the Data-in-Flight license is installed (see [License Keys on page 377](#)).

- c. In the **Source IP Address** field, enter the IP address that is used to uniquely identify the source DXi to the target. This may be different than the actual network IP address of the source DXi.

If the target system is at DXi 2.1 Software or higher, this field is not required. If the target system is at DXi 2.0.1.x Software or below, then you must enter the IP address by which the target system recognizes the source system. The default value is **0.0.0.0**.

- 2. If data on other DXi systems will be replicated to this DXi6900, enter the following information under **Source DXis**:

- a. In the **Source Hostnames or IP Addresses** box, enter the hostname or IP address of the system that will send the replicated data to the DXi6900.

You can specify up to 10 replication sources. To enter multiple sources, press **<Enter>** after each entry.

- b. In the **Maximum Snapshots Per Share or Partition** drop-down box, select the number of snapshots to retain for each replicated share or partition (up to 32).

During scheduled or manual data replication, the DXi6900 receives a snapshot from the source system. A snapshot contains all of the data necessary to fully recover or failback a NAS share or VTL partition to the point in time when the snapshot was saved.

- 3. Click **Next** to continue.

Figure 65: Replication Wizard: System

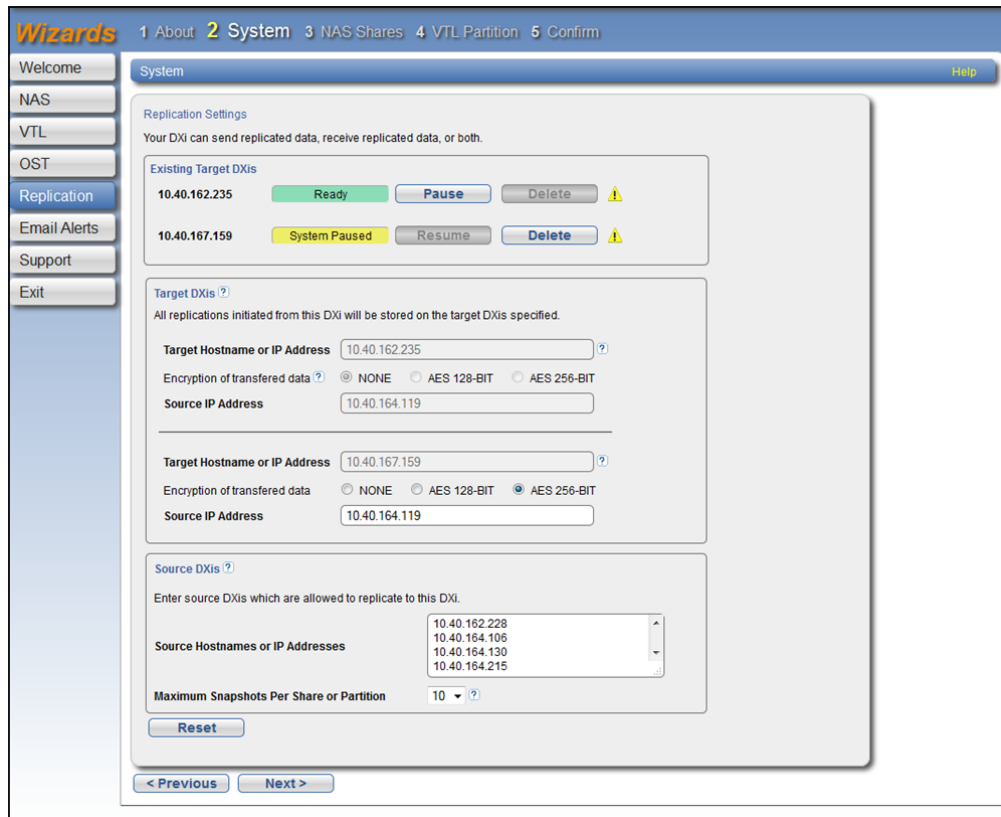

## Step 3: NAS Share

1. Select a NAS share in the **Replication Settings for NAS Shares** section to manage its replication settings (see [Figure 66 on page 113](#)).

**i Note:** For help adding NAS shares to the system, use the **NAS Configuration Wizard** (see [NAS Wizard \(DXi6900-S\) on page 87](#)).

2. To configure the share to replicate its data to another DXi system, enter the following information under **Send**:
  - a. Select the **Enable replication for selected share** check box to enable replication for the share.
  - b. (Optional on CIFS/SMB and NFS shares only) Select the **Enable Directory/File based replication to target** check box to enable Directory/File Based Replication for the share, and then enter a **Sync ID** in the box.

With Directory/File Based Replication, a file is automatically replicated when it is closed or a period of time after it is modified. After replication, the replicated files are immediately available on the target system.

**i Note:** Application Specific (RMAN) shares have Directory/File Based Replication enabled by default. When an RMAN share is selected, this check box does not appear.

The Sync ID is used to identify the target share that will receive replicated data from the source share. The Sync ID *must* be identical to the Sync ID of the target share on the target system.

- c. Select the check box for each replication target you want to replicate the share to. When the share is replicated, its data will be sent to all selected targets.
3. To configure the share to receive replicated data from another DXi system, enter the following information under **Receive**:

- a. (Optional) Select the **Enable Directory/File based replication to this DXi** check box to enable Directory/File Based Replication for the share, and then enter a **Sync ID** in the box.

The Sync ID is used to identify the source share that will send replicated data to the target share. The Sync ID *must* be identical to the Sync ID of the source share on the source system.

- b. If you enabled Directory/File Based Replication, select an **Access** option:

Access Option	Description
<b>Locked</b>	The share is not allowed to receive new Directory/File Based Replication data.
<b>Unlocked</b>	The share is allowed to receive new Directory/File Based Replication data.

 **Note:** You cannot configure a share to both send and receive Directory/File Based Replication data.

4. Click **Apply**.
5. (Optional) To configure additional shares for replication, repeat Steps 1–4.
6. Click **Next** to continue.



Figure 66: Replication Wizard: NAS Shares

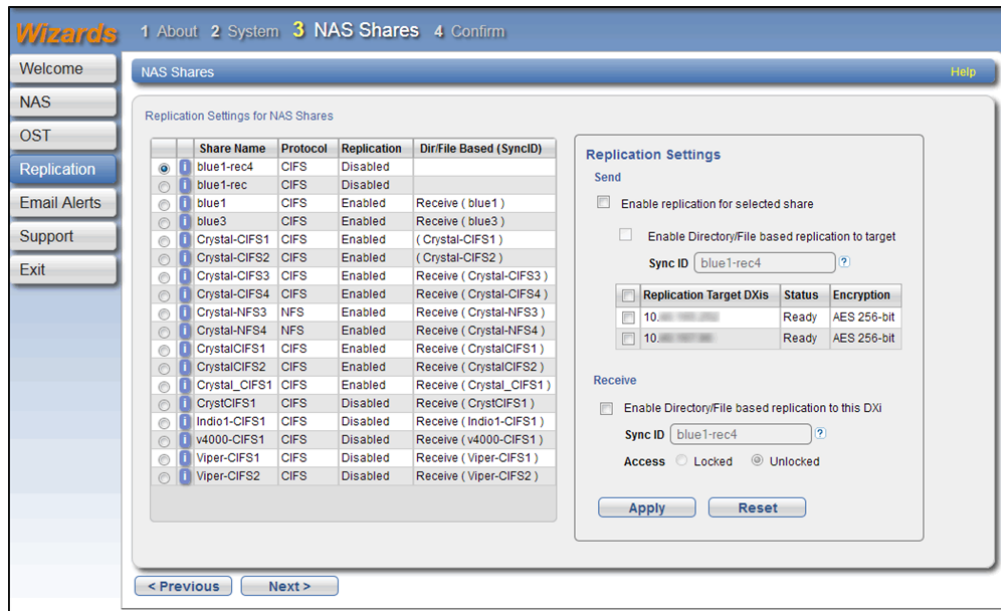

## Step 4: VTL Partition

1. Select a VTL partition in the **Replication Settings for VTL Partitions** section to manage its replication settings (see [Figure 67 on the next page](#)).

**Note:** For help adding VTL partitions to the system, use the **VTL Configuration Wizard** (see [VTL Wizard on page 94](#)).

2. To configure the partition to replicate its data to another DXi system, enter the following information under **Send**:

- a. Select the **Enable replication for selected partition** check box to enable replication for the partition.
- b. (Optional) Select the **Enable Cartridge based replication to target** check box to enable Cartridge Based Replication for the partition, and then enter a **Sync ID** in the box.

With Cartridge Based Replication, a cartridge is automatically replicated when it is unmounted. After replication, the replicated cartridges are immediately available on the target system.

The Sync ID is used to identify the target partition that will receive replicated data from the source partition. The Sync ID *must* be identical to the Sync ID of the target partition on the target system.

- c. Select the check box for each replication target you want to replicate the partition to. When the partition is replicated, its data will be sent to all selected targets.

3. To configure the partition to receive replicated data from another DXi system, enter the following information under **Receive**:

- a. (Optional) Select the **Enable Cartridge based replication to this DXi** check box to enable Cartridge Based Replication for the partition, and then enter a **Sync ID** in the box.

The Sync ID is used to identify the source partition that will send replicated data to the target partition. The Sync ID *must* be identical to the Sync ID of the source partition on the source system.

- b. If you enabled Cartridge Based Replication, select an **Access** option:

Access Option	Description
<b>Locked</b>	The partition is not allowed to receive new Cartridge Based Replication data.
<b>Unlocked</b>	The partition is allowed to receive new Cartridge Based Replication data.

**Note:** You cannot configure a partition to both send and receive Cartridge Based Replication data.

4. Click **Apply**.
5. (Optional) To configure additional partitions for replication, repeat Steps 1–4.
6. Click **Next** to continue.

**Figure 67:** Replication Wizard: VTL Partitions

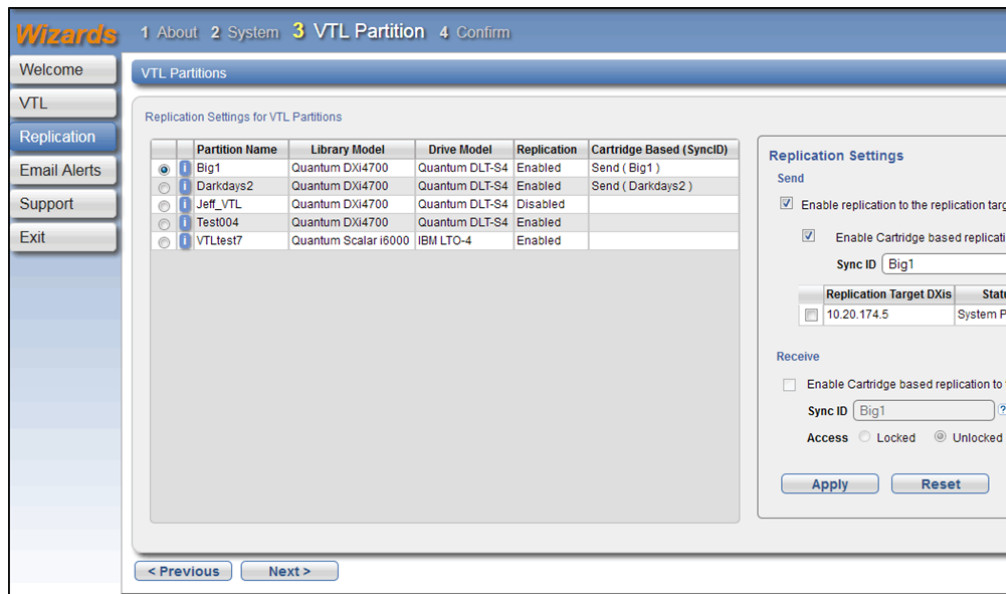

## Step 5: Confirm

1. Review the settings you selected to make sure they are correct. If necessary, click **Previous** to return to a previous step to make changes (see [Figure 68 on the next page](#)).
2. After you have confirmed all settings, click **Finish**. The wizard configures the DXi6900 with the settings you selected.

Figure 68: Replication Wizard: Confirm

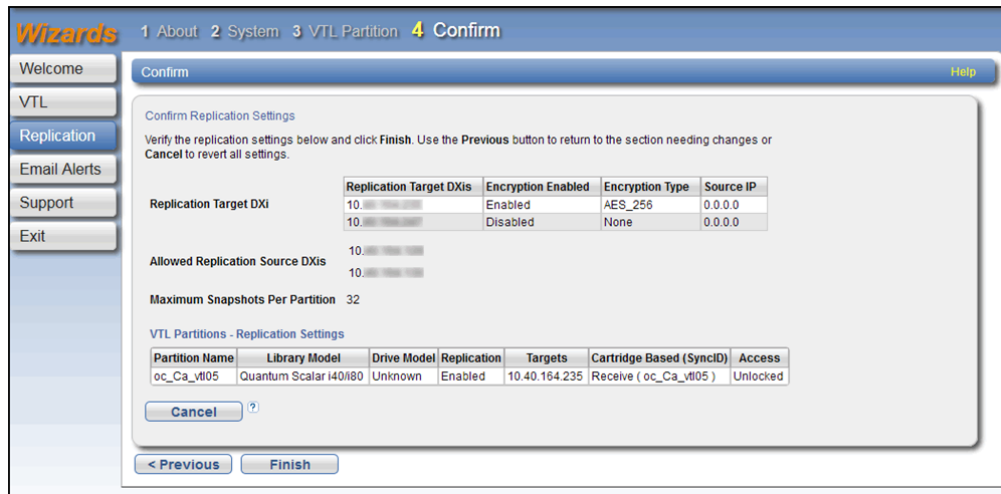

## Email Alerts Wizard

The **Email Alerts** wizard provides guided assistance for configuring the DXi6900 to automatically send notifications and reports to selected recipients. The wizard helps you configure an outgoing e-mail server. Then the wizard guides you through the process of specifying e-mail recipients and selecting the notifications and reports to send to the recipients.

**Note:** For more information about sending e-mail alerts, see [Email on page 304](#).

To begin the **Email Alerts** wizard, on the **Wizards** menu, click **Email Alerts**.

### Step 1: About

1. Read the information about the wizard (see [Figure 69 on the next page](#)).
2. Click **Next** to continue.

**Note:** At any time while using the wizard, you can click **Previous** to return to the previous step.

Figure 69: Email Alerts Wizard: About



## Step 2: Server

1. In the **Hostname or IP Address** box, enter the hostname or IP address of the outgoing e-mail server (see [Figure 70 on the next page](#)).

---

**i Note:** When entering IP addresses, never use an address that is in a reserved IP address range. To see a list of reserved IP address ranges, click the quick tip icon **[?]** located near the IP address field.

---

**i Note:** To use hostname format, you must specify at least one DNS IP address on the **Network** page (see [Network on page 322](#)).

2. In the **From Email Address** box, enter the return e-mail address displayed in e-mails sent by the DXi6900.
3. Specify a return address that lets you easily identify the system that generated the e-mail (for example, systemname@any-domain.com). The return address must contain an @ symbol and a valid domain name, including a period.
4. (Optional) Select the **Enable Admin Alerts about Email Server not configured** check box to have system generate administration alerts to notify you if an e-mail server is not configured.
5. (Recommended) Select the **Enable automatic emails to Quantum** check box to periodically send system configuration and status information to Quantum, including any software upgrades you have installed using the **Software Upgrade Utility**. Quantum Support can use this information to provide a better support experience in the future.

---

**i Note:** Automatic e-mails contain configuration and status information only, and do not contain any customer data stored on the system.

6. Click **Next** to continue.

Figure 70: Email Alerts Wizard: Server



## Step 3: Recipients

1. Click **Add** to add an e-mail recipient.
2. Under **Add Email Recipient**, enter information about the recipient (see [Figure 71 on page 119](#)):

Recipient Information	Description
<b>Name</b>	The name of the recipient.
<b>Email Address</b>	The e-mail address of the recipient.

Recipient Information	Description
<b>Notification Type</b>	<p>Select the types of notifications to send to the recipient:</p> <ul style="list-style-type: none"><li>• <b>High</b> - Send e-mail notifications for High service tickets. High service tickets indicate that a critical problem has occurred and needs to be resolved immediately. The operation and performance of the DXi6900 are degraded, and there is a risk of system failure or data loss.</li><li>• <b>High and Medium</b> - Send e-mail notifications for High and Medium service tickets. Medium service tickets indicate that a serious problem occurred and needs to be resolved, but it does not necessarily need to be fixed immediately. The operation and performance of the DXi6900 may be degraded.</li><li>• <b>All</b> - Send e-mail notifications for High, Middle, and Low service tickets, as well as any administration alerts. Low service tickets indicate that a minor problem occurred and needs to be resolved, but the operation and performance of the DXi6900 are not significantly affected.</li></ul>

3. Select the **Notification Enabled** check box to enable sending of notifications to the recipient.
4. Click **Add**.  
The recipient displays in the **Email Recipient** list.
5. (Optional) To add additional recipients, click **Add** and then repeat Steps 1–4.  
To change a recipient, select it in the **Email Recipient** list and click **Edit**. To remove a recipient, select it in the **Email Recipient** list and click **Delete**.
6. Click **Next** to continue.

**Figure 71:** Email Alerts Wizard: Recipients

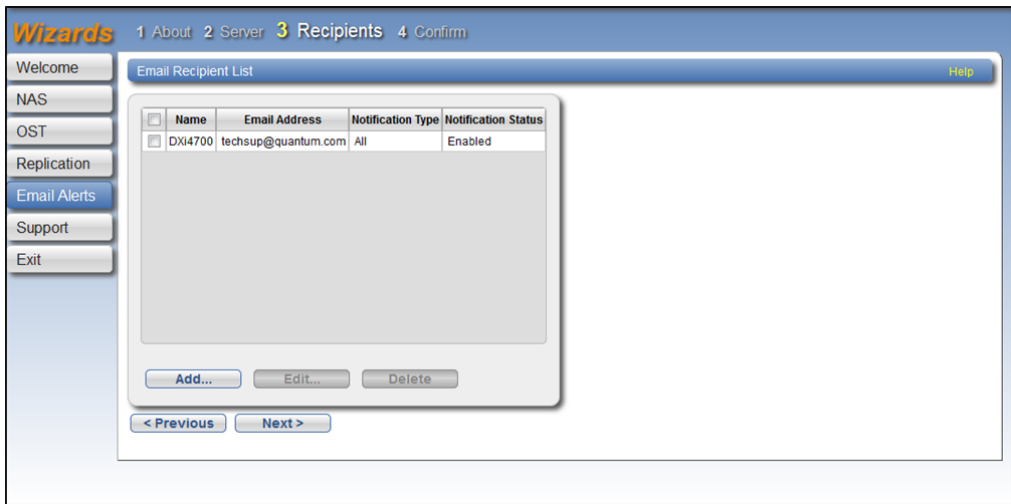

## Step 4: Confirm

1. Review the settings you selected to make sure they are correct. If necessary, click **Previous** to return to a previous step to make changes (see [Figure 72 on the next page](#)).
2. After you have confirmed all settings, click **Finish**. The wizard configures the DXi6900 with the settings you selected.

Figure 72: Email Alerts: Confirm

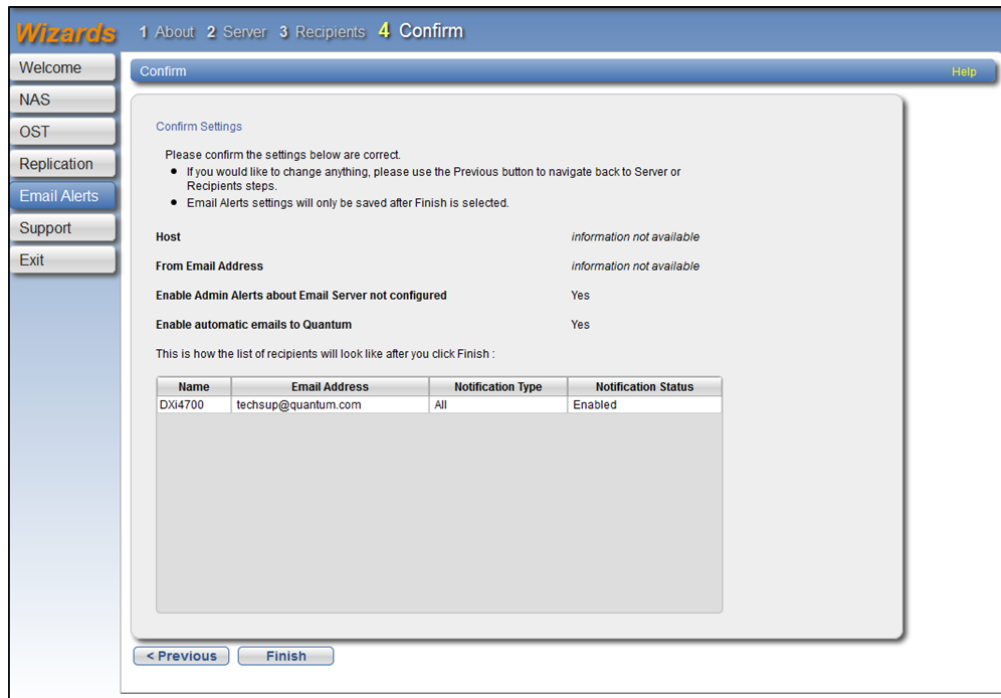

## Support Wizard

The **Support** wizard provides guided assistance to help you enable licensed features on the DXi6900 and register your system with Quantum. The wizard also guides you through other tasks that will aid Quantum customer support in assisting you, such as downloading StorageCare Guardian and creating a system log.

To begin the **Support** wizard, on the **Wizards** menu, click **Support**.

### Step 1: About

1. Read the information about the wizard (see [Figure 73 on the next page](#)).
2. Click **Next** to continue.

**Note:** At any time while using the wizard, you can click **Previous** to return to the previous step.



Figure 73: Support Wizard: About

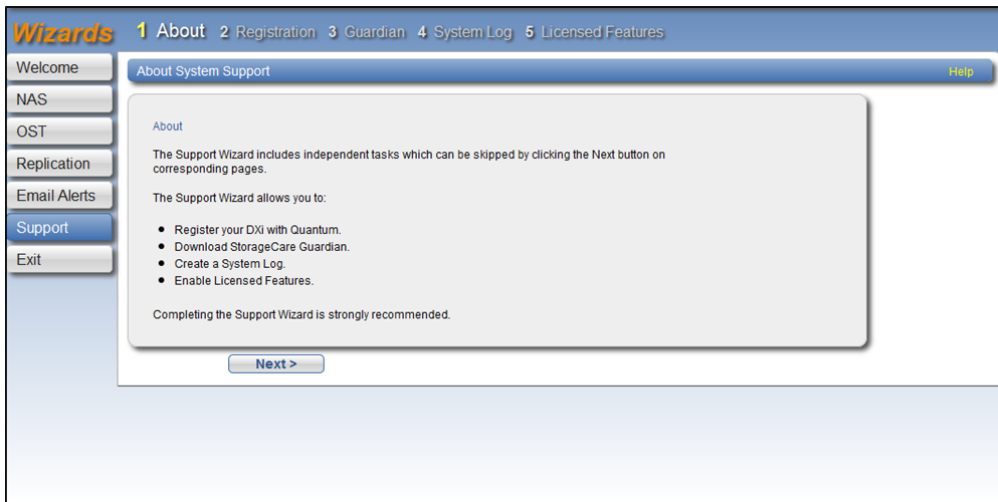

## Step 2: Registration

You must register your DXi6900 to receive service and support from Quantum.

1. Click the link for [Quantum's Product Registration](#) site (see [Figure 74 below](#)).
2. Follow the onscreen instructions to register your system.
3. When you are finished, switch back to the **Support** wizard.
4. Click **Next** to continue.

Figure 74: Support Wizard: Registration

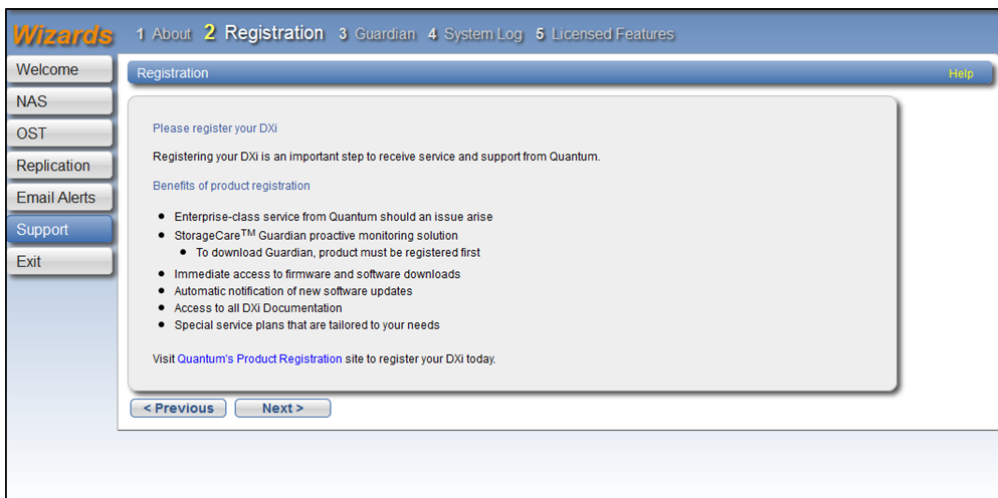

## Step 3: Guardian

StorageCare Guardian delivers more reliable operation and faster resolution time for customers at no additional cost for supported products under warranty or service contract.

1. Click the link to [learn more](#) about the features and benefits of StorageCare Guardian (see [Figure 75 below](#)).
2. Click the link to [download StorageCare Guardian](#), and then install it on a workstation with outgoing Internet access.

For more information, see the *StorageCare Guardian Installation Guide*. You can download a copy of the *Installation Guide* by clicking the link under **Documentation** on the StorageCare Guardian download page.

3. When you are finished, switch back to the **Support** wizard.
4. Click **Next** to continue.

**Figure 75:** Support Wizard: Guardian

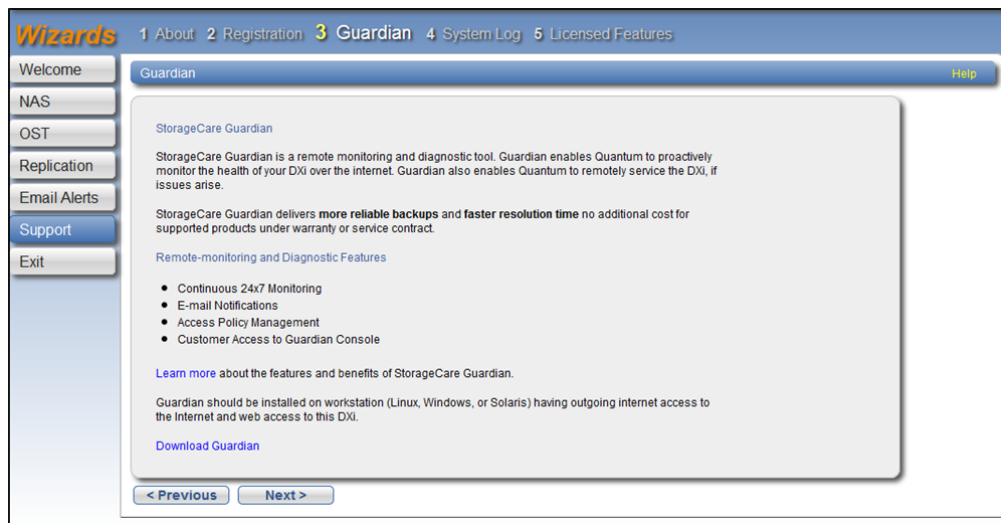

## Step 4: System Log

This system diagnostics file contains the diagnostic logs for all of the system components. The diagnostic files are helpful when troubleshooting problems on the DXi6900. You should generate a system diagnostic file after setting up your DXi6900 and save it for future reference.

1. Click **Generate New** to generate a new system diagnostics file (see [Figure 76 on the next page](#)).  
The system generates a new diagnostics file. This can take several minutes.
2. After the file finishes generating, click the link to enable the **Download Current** button.
3. To download the generated diagnostics file, click **Download Current**.

A dialog box displays asking if you want to open or save the file.

4. Click **Save** or **OK** to download the file.
5. Click **Next** to continue.

**Figure 76:** Support Wizard: System Log

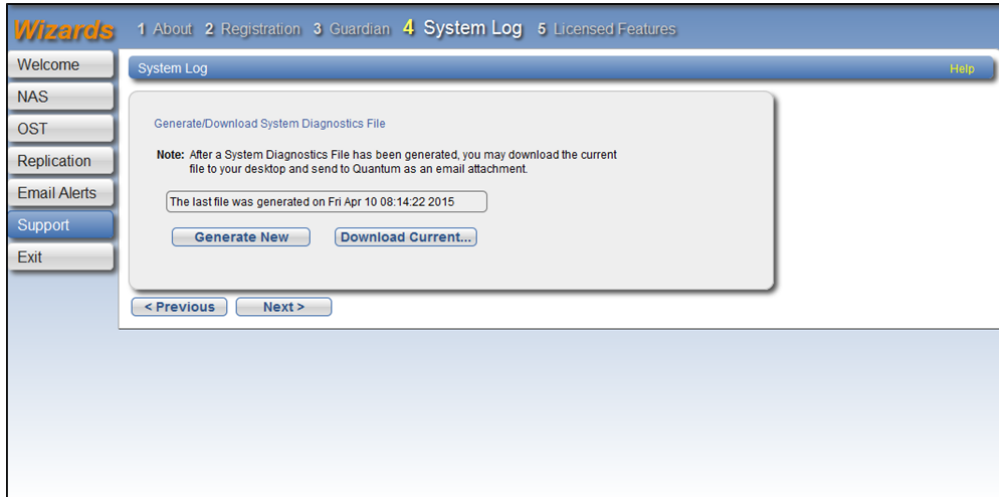

## Step 5: Licensed Features

Add a license key to enable new functionality on the DXi6900. To install a license key, you must first obtain a License Certificate containing an authorization code.

Contact your Quantum sales representative to purchase a license. After you purchase the license, you will receive a License Certificate containing an authorization code.

**Note:** Some licenses are pre-installed on the DXi6900. In addition, License Certificates for some licenses may be included with the DXi6900. For more information about licensed features, see [License Keys on page 377](#).

1. Select the DXi system serial number (displayed under **Enable Licensed Features**) and press **<Ctrl+C>** to copy it (see [Figure 77 on the next page](#)).
2. Click the link for [Quantum's License Key Management](#) site.  
The **License Key Management** page displays.
3. Click to place the cursor in the **Serial Number** box and press **<Ctrl+V>** to paste the DXi system serial number.
4. Click **Submit**.  
The **Licensed Feature** page displays.
5. Enter the authorization code (printed on the License Certificate) and click **Get License Key**.  
The **Licensed Feature** page returns a license key. Select the license key and press **<Ctrl+C>** to copy it. You should also print out or write down the license key, or save it to a text file, for future use.

6. Switch back to the **Support** wizard.
7. Enter the license key in the **New Key** box, and then click **Add**.  
The license key is added to the system, and the new feature is enabled.
8. (Optional) To add additional license keys, repeat Steps 1–7.
9. Click **Finish** to complete the **Support** wizard.

Figure 77: Support Wizard: Licensed Features

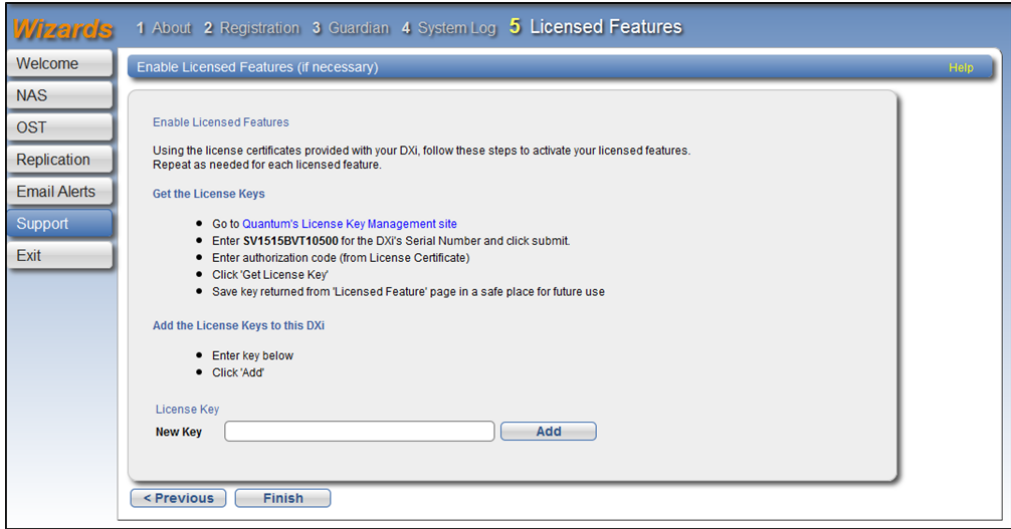



# Chapter 5: Home Page

---

This chapter contains the following topics:

Home Page .....	125
System Overview .....	127
Disk Usage .....	128
Data Reduction Statistics .....	130
Replication .....	131
Current Activity .....	134

---

## Home Page

The first page that displays after you log on to the DXi6900 remote management console is the **Home** page (see [Figure 78 on the next page](#) and [Figure 79 on page 127](#)). Use the **Home** page to see important performance information at a glance, including disk usage, data reduction statistics, and replication activity.

To return to the **Home** page at any time, click **Home** on the main menu.

The **Home** page contains the following overviews:

- [System Overview on page 127](#)
- [Disk Usage on page 128](#)
- [Data Reduction Statistics on page 130](#)

- [Replication on page 131](#)
- [Current Activity on page 134](#)

**i Note:** Disk usage statistics, data reduction statistics, replication statistics, and current activity are updated every 30 seconds.

Figure 78: DXi6900 Home Page

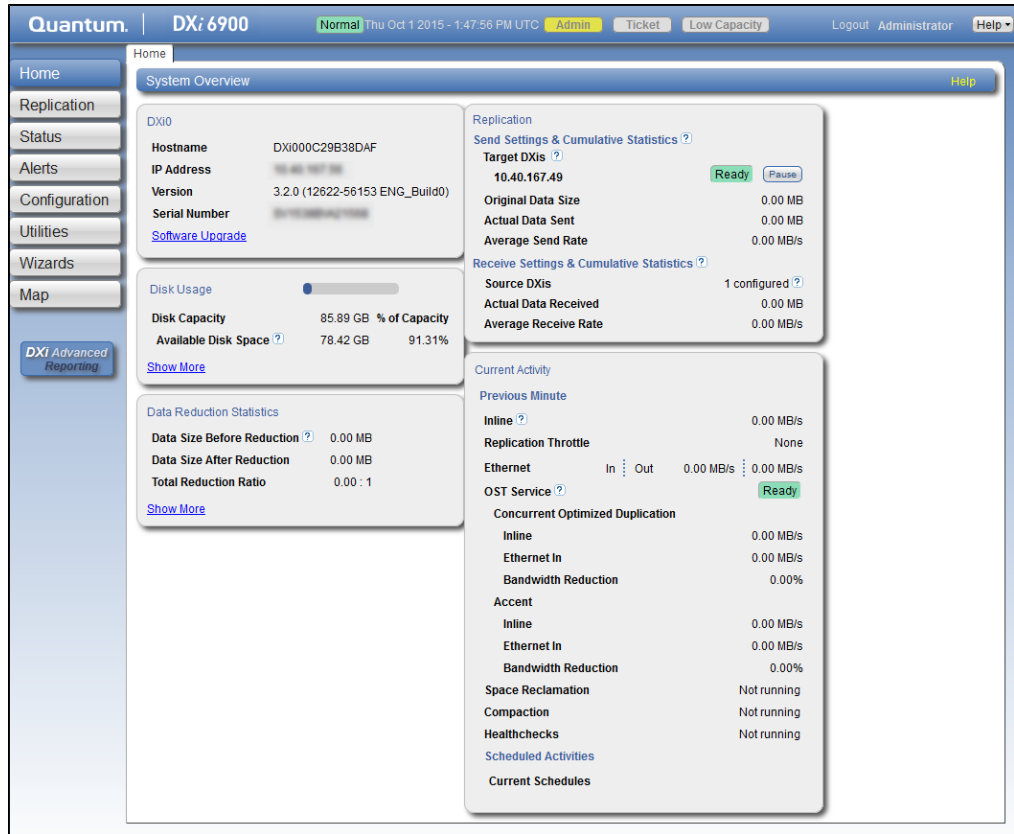
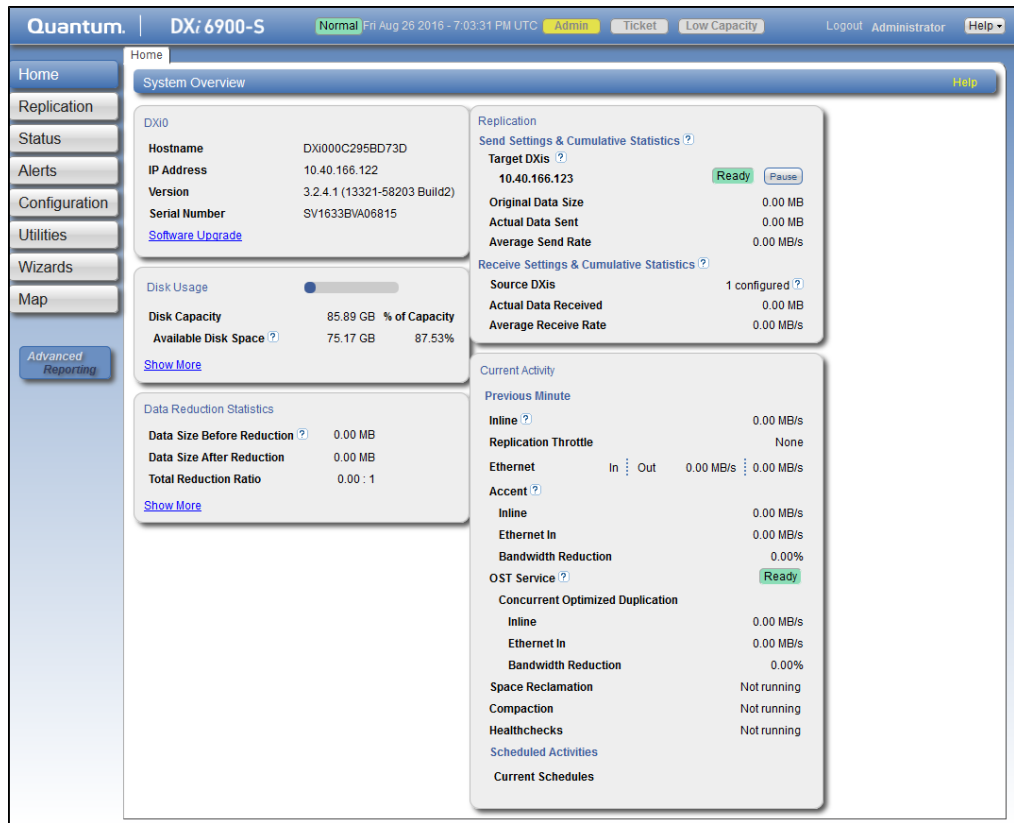

Figure 79: DXi6900-S Home Page



## System Overview

The **DXi6900 System Overview** on the **Home** page (see [Figure 80 below](#)) displays the following information about the system:

Figure 80: DXi6900 System Overview

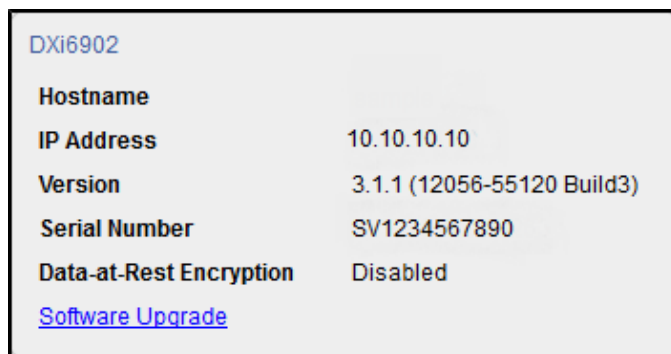

System Information	Description
<b>Hostname</b>	The hostname of the DXi6900. Click to change the hostname (see <a href="#">Network on page 322</a> ).
<b>IP Address</b>	The IP address of the DXi6900. Click to change the IP address (see <a href="#">Network on page 322</a> ).
<b>Version</b>	The software version installed on the DXi6900. A Quick Tip icon indicates if a software upgrade is available for the DXi6900. Click to upgrade the software (see <a href="#">Checking For Software Upgrades (DXi6900) on page 385</a> ).
<b>Serial Number</b>	The serial number of the DXi6900. (You need to know the serial number to add a licensed feature. For more information, see <a href="#">License Keys on page 377</a> .)
Data-at-Rest Encryption	The status of Data-at-Rest encryption ( <b>Enabled</b> or <b>Disabled</b> ). (To enable Data-at-Rest encryption, see <a href="#">Data-at-Rest Encryption on page 352</a> ).
<b>Software Upgrade</b>	Click to displays the <b>Software Upgrade Utility</b> (see <a href="#">Software Upgrades on page 384</a> ).

## Disk Usage

The **Disk Usage** overview on the **Home** page (see [Figure 81 below](#)) displays the following information about disk usage as an amount and as a percentage of the total capacity in the system:

**Figure 81:** Disk Usage Overview

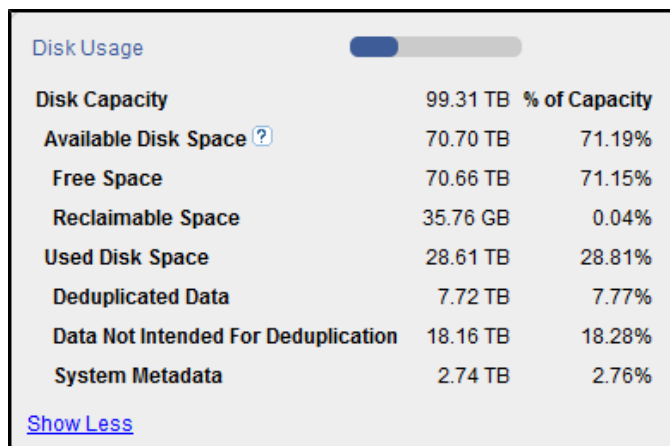

The screenshot shows a 'Disk Usage' section with a progress bar indicating approximately 28% usage. Below the progress bar is a table with the following data:

	Amount	% of Capacity
<b>Disk Capacity</b>	99.31 TB	
<b>Available Disk Space</b> <sup>?</sup>	70.70 TB	71.19%
<b>Free Space</b>	70.66 TB	71.15%
<b>Reclaimable Space</b>	35.76 GB	0.04%
<b>Used Disk Space</b>	28.61 TB	28.81%
<b>Deduplicated Data</b>	7.72 TB	7.77%
<b>Data Not Intended For Deduplication</b>	18.16 TB	18.28%
<b>System Metadata</b>	2.74 TB	2.76%

[Show Less](#)



Disk Usage Information	Description
<b>Disk Capacity</b>	The total usable disk capacity of the DXi6900.
<b>Available Disk Space</b>	<p>The disk space available for data storage (free space).</p> <p>On the disk space meter, blue (left side of meter) indicates used disk space and gray (right side of meter) indicates available disk space. The left side of the meter changes color based on the amount of remaining free disk space and the state of the DXi6900. For more information, see <a href="#">Low Space Management on page 72</a>.</p>

**Additional Information**

- When disk space is low, click the **Quick Warning** icon [!] next to the space meter to see more information.
- When disk space is low, target replication to the system is paused (see [Replication Service on page 174](#)).
- Space reclamation is automatically started to free up disk space (see [Space Reclamation on page 374](#)).
- For optimal system performance, Quantum recommends keeping the amount of **Available Disk Space** (free space) at 20% or more.

Click **Show More** to display additional information:

Show More Information	Description
<b>Free Space</b>	The disk space that can be used for new deduplicated or non-deduplicated data.
<b>Reclaimable Space</b>	The disk space that is occupied by outdated deduplicated data and which will be automatically reused if additional space for new deduplicated data is needed.
<b>Used Disk Space</b>	The disk space that already holds data, including deduplicated data, system metadata, and data not intended for deduplication.
<b>Deduplicated Data</b>	The amount of data that has been deduplicated.
<b>Data Not Intended for Deduplication</b>	The amount of data on shares or partitions that do not have deduplication enabled.
<b>System Metadata</b>	The amount of disk space used for internal operations of the DXi, including system configuration files as well as temporary files created during replication, space reclamation, and healthchecks.

Click an item to view detailed statistics for disk usage (see [Disk Usage on page 190](#)).

# Data Reduction Statistics

The **Data Reduction Statistics** overview on the **Home** page (see [Figure 82 below](#)) displays the following information about the results of data reduction:

**Figure 82:** Data Reduction Statistics Overview

Data Reduction Statistics	
Data Size Before Reduction <a href="#">?</a>	53.21 TB
Data Size After Reduction	7.72 TB
Total Reduction Ratio	6.89 : 1
<a href="#">Show More</a>	

Data Reduction Information	Description
<b>Data Size Before Reduction</b>	The original, native size of all data that has been processed by the data deduplication and compression engines.
<b>Data Size After Reduction</b>	The final, reduced size of all data that has been processed by the data deduplication and compression engines.
<b>Total Reduction Ratio</b>	The total reduction ratio of all data that has been processed by the data deduplication and compression engines ( <b>Data Size Before Reduction</b> divided by <b>Data Size After Reduction</b> ).

Click **Show More** to display additional information:

Show More Information	Description
<b>Incoming Replication</b>	The amount of data stored on the DXi via replication from another DXi. This does <i>not</i> include incoming data from Directory/File or Cartridge Based Replication, or incoming data from Failback replication.
<b>Shares &amp; Partitions</b>	The amount of data stored on the DXi via local I/O. This includes incoming data from Directory/File or Cartridge Based Replication, and incoming data from Failback replication.
<b>OST Storage Servers</b>	The amount of data stored in deduplicated OpenStorage (OST) storage servers. This includes incoming data for OST and DXi Accent.
<b>Deduplication Ratio</b>	The deduplication ratio of all data that has been processed by the data deduplication engine.
<b>Compression Ratio</b>	The compression ratio of all data that has been processed by the compression engine.

Click an item to view detailed statistics for disk usage (see [Disk Usage on page 190](#)).

---

# Replication

The **Replication** overview on the **Home** page (see [Figure 83 below](#)) displays the following information about target and source replication activity:

**Figure 83:** Replication Overview

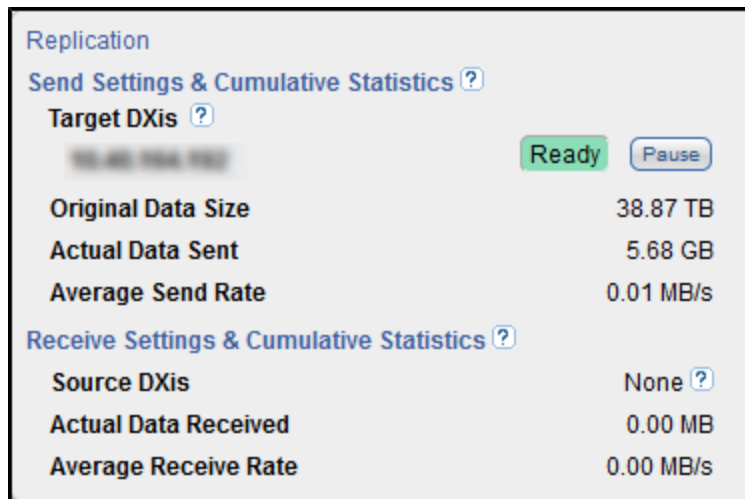

## Send Settings & Cumulative Statistics

The **Send Settings & Cumulative Statistics** section displays statistics for all data sent from the system since system installation or since Send cumulative replication statistics were last cleared by clicking **Clear Send** on the **Replication Actions** page (see [Replication Performance on page 175](#)).

Send Settings Information	Description
<b>Target DXis</b>	<p>The IP address and replication status for each configured replication target (up to two). Click to specify a replication target (see <a href="#">Replication Configuration on page 282</a>).</p> <p><b>Status</b></p> <ul style="list-style-type: none"><li>• <b>Ready</b> - (Green)The system is ready to perform replication.</li><li>• <b>In Progress</b> - (Blue) A replication job is currently in progress.</li><li>• <b>Queued</b> - (Blue) A replication job is queued and will continue when the system is ready.</li><li>• <b>Partial</b> - (Yellow) A replication job was partially completed. Generate a replication report to see the files that were not replicated (see <a href="#">Reports on page 176</a>).</li><li>• <b>Manually Paused</b> - (Yellow) Replication was manually paused. To resume replication, click Resume.</li><li>• <b>System Paused</b> - (Yellow) The system has automatically paused replication due to a problem, for example, low disk space or a problem on the target system.</li></ul> <p>To see more information about the problem that occurred, click Admin at the top of the remote management console to view administration alerts (see <a href="#">Admin Alerts on page 206</a>). You may also need to view alerts on the target DXi. In addition, make sure that the DXi is an allowed replication source on the target DXi (see <a href="#">Replication Configuration on page 282</a>).</p> <ul style="list-style-type: none"><li>• <b>Failed</b> - (Red) A replication job was not completed.</li><li>• <b>Internal Error</b> - (Red) An error occurred during replication.</li></ul>
<b>Pause/Resume</b>	<p>The source DXi controls the replication pause behavior. To manually pause replication between the source and target, click <b>Pause</b> on the source DXi. To manually restart replication, click <b>Resume</b> on the source DXi.</p> <p><b>Note:</b> When the target DXi enters low disk space condition, replication on the source DXi is automatically paused. Replication will resume when the target leaves low disk space condition.</p>
<b>Original Data Size</b>	<p>The original, native size of data sent during replication or failback. This value does not represent the amount of data actually sent over the network during replication or failback because data is deduplicated and compressed before being sent.</p>

Send Settings Information	Description
<b>Actual Data Sent</b>	The amount of data actually sent over the network during replication or failback. This value is usually much less than the <b>Original Data Size</b> due to the benefits of data deduplication and compression.
<b>Average Send Rate</b>	The average send rate (in MB/s) of data sent over the network during replication or failback (actual size of data sent over the network divided by the amount of time required to complete replication or failback)

### Additional Information

- **Average Data Sent** is based on actual bytes sent over network, the average send rate could be low if differential between the replications is low
- The **Average Send Rate** can be low if a replication target is un-configured and configured again. The replication send statistics for a particular target are reset when it is un-configured. Only new replications to the target will be considered when calculating average replication rate.
- OST network traffic may or may not be considered when calculating actual data statistics. It is considered only if the storage server has the following configuration:
  - Concurrent optimized duplication enabled.
  - Unique data gets replicated through concurrent optimized replication and not through an actual optimized duplication operation.
- The replication metadata transferred over network is not considered in calculating **Average Send Rate** statistics.

## Receive Settings & Cumulative Statistics

The **Receive Settings & Cumulative Statistics** section displays statistics for all data received by the system from all sources since system installation or since **Receive** cumulative replication statistics were last cleared by clicking **Clear Receive** on the **Replication Actions** page (see [Replication Performance on page 175](#)).

Receive Settings Information	Description
<b>Source DXIs</b>	The number of source systems configured to replicate data to the DXi6900. Click to specify replication sources (see <a href="#">Replication Configuration on page 282</a> ).
<b>Actual Data Received</b>	The amount of data actually received over the network during replication or failback.
<b>Average Receive Rate</b>	The average receive rate (in MB/s) of data received over the network during replication or failback (actual size of data sent over the network divided by the amount of time required to complete replication or failback).

# Current Activity

The **Current Activity** overview on the **Home** page (see [Figure 84 below](#) and [Figure 85 on the next page](#)) displays the following information about system activity that occurred in the previous minute:

**Figure 84:** DXi6900 Current Activity Overview

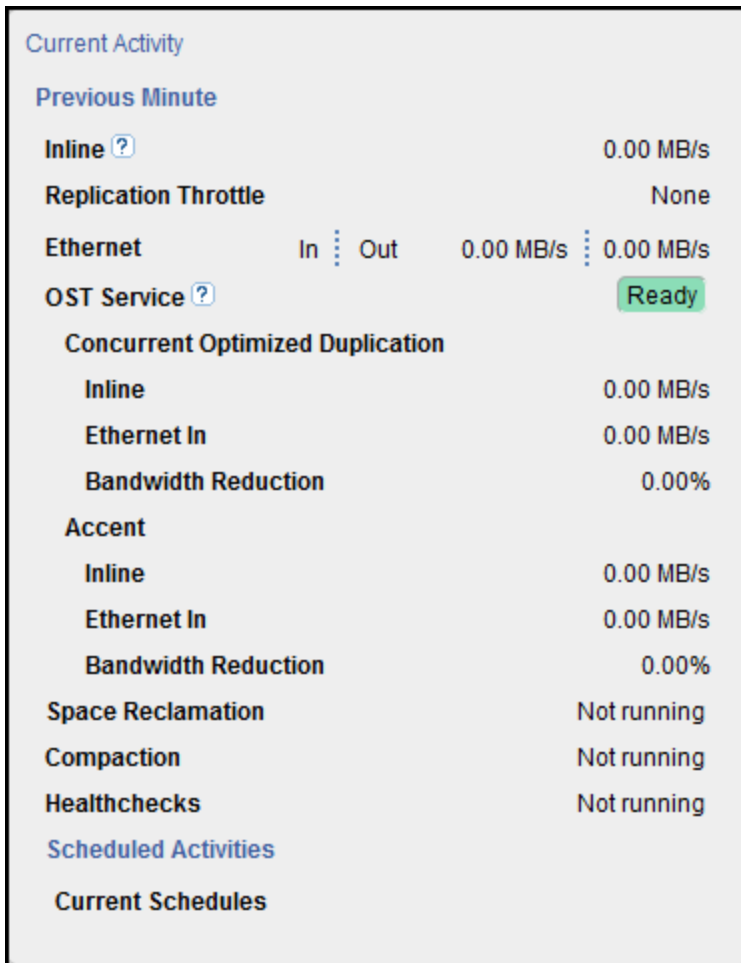

**Figure 85:** DXi6900-S Current Activity Overview

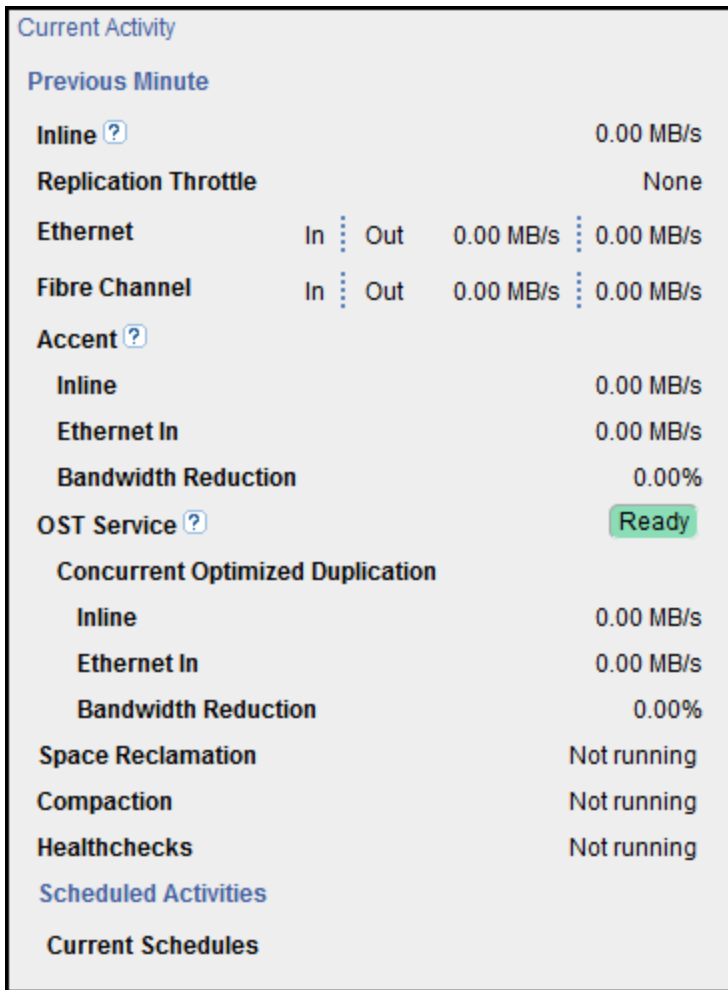

Current Activity Information	Description
<b>Inline</b>	The inline data flow throughput (in MB/s). Inline data flow includes deduplicated and non-deduplicated backup data as well as received OST data. Click to view detailed statistics for inline performance (see <a href="#">Inline on page 186</a> ).
<b>Replication Throttle</b>	The system replication throttle currently in effect (in KB/s or MB/s). When a constant throttle is enabled, the DXi limits the amount of data it sends during source replication so that it does not exceed the specified bandwidth. Click to enable or disable system throttling (see <a href="#">Replication Configuration on page 282</a> ).

Current Activity Information	Description
<b>Ethernet</b>	The amount of data received ( <b>In</b> ) and sent ( <b>Out</b> ) by all Ethernet ports (in MB/s). Click to view details statistics for Ethernet performance (see <a href="#">Ethernet on page 186</a> ).
<b>Fibre Channel</b>	The amount of data received ( <b>In</b> ) and sent ( <b>Out</b> ) by all Ethernet ports (in MB/s). Click to view details statistics for Fibre Channel performance (see <a href="#">Fibre Channel on page 188</a> ).
<b>Accent (DXi6900-S)</b>	<p>Accent statistics include NAS Application Specific (RMAN) and OST Accent throughput activity for the previous minute.</p> <p><b>Inline</b> - The inline data flow throughput (in MB/s). Inline data flow represents the original, native size of the data protected by the DXi.</p> <p><b>Ethernet In</b> - The amount of data received by all Ethernet ports (in MB/s). This amount represents the reduced size of the data protected by the DXi (after deduplication and compression on the media servers).</p> <p><b>Bandwidth Reduction</b> - The percentage by which network bandwidth utilization was reduced by Accent and/or RMAN.</p>
<b>OST Service</b>	The status of the OST service. OST settings can be configured in <b>Ready</b> , <b>Stopped</b> , or <b>Verifying</b> state. The OST server is available for backup only in <b>Ready</b> state.
<b>Concurrent Optimized Duplication</b>	<p><b>Inline</b> - The inline data flow throughput (in MB/s). Inline data flow represents the original, native size of the data protected by the DXi.</p> <p><b>Ethernet In</b> - The amount of data received by all Ethernet ports (in MB/s). This amount represents the reduced size of the data protected by the DXi (after deduplication and compression on the media servers).</p> <p><b>Bandwidth Reduction</b> - The percentage by which network bandwidth utilization was reduced by using Optimized Duplication.</p>



Current Activity Information	Description
<b>Accent (DXi6900)</b>	<p><b>Inline</b> - The inline data flow throughput (in MB/s). Inline data flow represents the original, native size of the data protected by the DXi.</p> <p><b>Ethernet In</b> - The amount of data received by all Ethernet ports (in MB/s). This amount represents the reduced size of the data protected by the DXi (after deduplication and compression on the media servers).</p> <p><b>Bandwidth Reduction</b> - The percentage by which network bandwidth utilization was reduced by enabling Accent.</p>
<b>Space Reclamation</b>	The status of space reclamation ( <b>Not running</b> or <b>Percent complete</b> ). Click to start or stop space reclamation (see <a href="#">Space Reclamation on page 374</a> ).
<b>Compaction</b>	The status of space compaction ( <b>Not running</b> or <b>Running</b> ).
<b>Healthchecks</b>	The status of healthchecks ( <b>Not running</b> or <b>Percent complete</b> ). Click to start or stop space healthchecks (see <a href="#">Healthchecks on page 369</a> ).

To view or modify scheduled system activity, click **Current Schedules** (see [Scheduler on page 297](#)).

#### Additional Information

- For more detailed information about all system activity, see [Status on page 177](#).
- DXi Accent activity displays only if DXi Accent is currently enabled or was previously enabled (see [DXi Accent on page 281](#)).



# Chapter 6: Replication

---

This chapter contains the following topics:

Replication .....	138
Replication Send .....	145
Receive NAS .....	153
Receive VTL .....	163
Actions .....	173
Reports .....	176

---

## Replication

The DXi6900 provides data replication capabilities that you can use as an integral part of a disaster recovery plan. Replication allows you to configure the DXi6900 to create a copy of your data on another DXi system at scheduled intervals (or manually as needed).

In the event of a disaster in which the original data is lost, you can quickly recover the replicated data on the remote system, allowing your business to resume normal operations. Once the original system is available again, you can restore all data back to its original location.

### Additional Information

- Quantum recommends that you configure and start replication before storing large amounts of data on the DXi6900.

**i Note:** To schedule replication for a share or partition, use the **Configuration > Scheduler** page (see [Scheduling a Share or Partition for Replication on page 300](#)). To limit the amount of network bandwidth used for replication, enable a constant throttle (see [Enabling System Throttling on page 288](#)), or schedule replication throttling (see [Scheduling Replication Throttling on page 301](#)).

## Understanding Data Replication

During data replication, data is sent from one system (the source) to another system, usually in another location (the target). For example, you might replicate data from a branch office (the source) to a central office (the target).

Sources *send* replicated data, and targets *receive* replicated data. A target system can receive data from up to ten sources. A source system can send data to up to two targets. Finally, one system can act as both a source and a target.

Replication works only with deduplicated data, and data is compressed before it is replicated. Because of this, the amount of data transmitted between systems during replication is greatly reduced compared to the original amount of data stored. In addition, a data block is transmitted only if the target does not already have a copy of the block. Finally, data can optionally be encrypted before it is transmitted.

The DXi6900 can perform the following types of replication:

### Replication

Replication occurs when replication is enabled for a deduplicated NAS share or VTL partition and a replication schedule is configured (or manual replication is performed on a regular basis). For replication to occur, the source system must be configured to point to the target system. Similarly, the target system must be configured to accept data from the source system.

To optimize the replication process, deduplicated data is continuously sent in the background from the source system to the target system. However, a snapshot that preserves the file structure of your data is sent to the target system only when a scheduled or manual replication job occurs. A snapshot contains all of the information that is necessary to recreate a share or partition just as it was at the point in time when the snapshot was created.

**⚠ Caution:** A saved snapshot is necessary to recover your data at a later time. For this reason, it is not enough to simply enable replication for a share or partition. You must also configure a replication schedule (recommended) or perform manual replication on a regular basis to send snapshots of the share or partition to the target system.

If the source system ever becomes unavailable, you can recover the share or partition on the target system using a saved snapshot. After you recover a share or partition, it is recreated on the target system and is available for use. Once the source system becomes available again, you can perform a failback operation to restore the share or partition to its original location.

## Directory/File or Cartridge Based Replication

Like replication, Directory/File or Cartridge Based Replication sends data from a NAS share or VTL partition to another system where it can be accessed. However, Directory/File or Cartridge Based Replication differs in a number of important ways:

- Both replication and Directory/File or Cartridge Based Replication must be enabled for the share or partition.
- A unique Sync ID is used to associate the replicated share or partition on the source system with the share or partition that will receive the replicated data on the target system.
- You do not need to schedule or manually perform Directory/File or Cartridge Based Replication through the remote management console. Instead, replication is triggered when a file is closed or a period of time after it is modified (NAS shares), or when a tape cartridge is unmounted (VTL partitions).

---

**i Note:** For CIFS/SMB shares, a file is replicated immediately after it is closed. For NFS shares, a file is replicated after it has been idle (not accessed) for several minutes.

---

**i Note:** To optimize the replication process, deduplicated data is continuously sent in the background from the source system to the target system. Any remaining data is sent (along with metadata) at the time a file is closed or a tape cartridge is unmounted.

- After files or cartridges are replicated using Directory/File or Cartridge Based Replication, they are automatically recovered on the target system and are immediately available for use. There is no need to first recover the share or partition to access its data.
- Deletions are automatically propagated from the source system to the target system in order to free up space on the target. In addition, you can manually initiate a synchronization from the source system at any time. Synchronizing ensures that the contents of the source share or partition are exactly the same as the target share or partition.

---

**! Caution:** Cartridge barcodes for all source systems that are replicating to the same target must be unique.

---

**i Note:** If you delete a share configured for Directory/File Based Replication on the source DXi, the share is *not* automatically deleted on the target DXi. If you do not want to retain the share on the target DXi, you can manually delete it.

## OST Optimized Duplication

The DXi6900 can duplicate the data on an LSU (logical storage unit) to another location using the OST optimized duplication (OST replication) feature supported by Veritas NetBackup and Backup Exec. If you are using Veritas NetBackup 7.1 or higher, you can configure an LSU for Automatic Image Replication.

For information about configuring and using OST optimized duplication and Automatic Image Replication, see [Replicating OST Data on page 258](#).

## Multiple Target Replication

The DXi6900 can send replicated data to multiple target systems. First, configure up to two replication

targets (see [Adding a Replication Target on page 284](#)). Then, for each share or partition, select which targets to replicate data to—one, both, or neither (see [Enabling Replication For a Share or Partition on page 148](#)).

Below are three possible scenarios in which multiple replication targets are configured.

### All Shares or Partitions Replicate to Multiple Targets

For enhanced disaster recovery, all shares or partitions on the DXi6900 are configured to replicate to multiple targets. In this scenario, even if one target system is lost, the other target system still retains a full copy of all data on the source DXi6900.

### Some Shares or Partitions Replicate to Multiple Targets

For increased flexibility, each share or partition on the DXi6900 is configured to replicate only to the targets where needed. In this scenario, shares or partitions fall into three categories:

- Some shares or partitions replicate to Target 1. (They may also replicate to Target 2.)
- Some shares or partitions replicate to Target 2. (They may also replicate to Target 1.)
- Some shares or partitions are not replicated.

## Performing Data Replication

The **Replication** page allows you to set up replication for NAS shares or VTL partitions and to replicate and recover data.

To access the **Replication** page, click the **Replication** menu.

The **Replication** page contains the following tabs:

- [Replication Send on page 145](#)
- [Receive NAS on page 153](#)
- [Receive VTL on page 163](#)
- [Actions on page 173](#)
- [Reports on page 176](#)

### Task Overview

Use the DXi6900 data replication features to perform the following tasks:

- Replicate all data on a share or partition to another system where it can be recovered at a later time (see [Task Overview: Setting Up and Performing Replication on the next page](#)).
- Automatically replicate files or cartridges to another system where they are immediately available (see [Task Overview: Setting Up and Performing Directory/File or Cartridge Based Replication on page 143](#) [Task Overview: Setting Up and Performing Directory/File or Cartridge Based Replication on page 143](#)).

- Restore a lost or damaged share or partition back to its original location (see [Task Overview: Performing a Share or Partition Failback on page 144](#)).
- Recover data from a lost or damaged share or partition (see [Task Overview: Recovering a Replicated Share or Partition on page 144](#)).

**i Note:** The **Replication** wizard provides guided assistance for configuring data replication (see [Configuration Wizards on page 79](#)).

### Task Overview: Setting Up and Performing Replication

To replicate all data on a NAS share or VTL partition from a source system to a target system:

1. On the target system, add the source system to the list of allowed replication sources (see [Adding a Replication Source on page 290](#)).
2. On the source system, specify the target system that will receive replicated data (see [Adding a Replication Target on page 284](#)).
3. On the source system, create a new share or partition with deduplication enabled (see [Adding a NAS Share on page 218](#) or [Adding a VTL Partition on page 233](#)).
4. Enable replication for the new share or partition (see [Enabling Replication For a Share or Partition on page 148](#)).
5. Before writing any data to the new share or partition, replicate the new share or partition (see [Replicating a Share or Partition on page 151](#)).

Quantum recommends that you always replicate a new share or partition immediately after creating it. This establishes the initial data structure on the target system and greatly increases the speed of the first replication.

6. Choose one of the following methods to regularly replicate the new share or partition:
  - (Recommended) Use the **Scheduler** page to set up a schedule for performing replication automatically after backups complete (see [Scheduling a Share or Partition for Replication on page 300](#)).
  - Manually perform replication at frequent intervals (see [Replicating a Share or Partition on page 151](#)).

After replication, a snapshot is sent to the target system. You can use the snapshot to recover the replicated share or partition on the target system (see [Task Overview: Recovering a Replicated Share or Partition on page 144](#)) or restore the share or partition to its original location on the source system (see [Task Overview: Performing a Share or Partition Failback on page 144](#)).

### Important Information: Setting up and Performing Replication

- If you do not configure a replication schedule or manually replicate the share or partition on a regular basis, your data is *not* protected. While the DXi6900 continually sends data to the target system in the background to optimize the replication process, a snapshot that preserves the complete structure of

your data is sent to the target system *only* when a scheduled or manual replication job occurs. If you do not regularly and frequently replicate your data as described in Step 6 above, it cannot be restored at a later time.

- If a replication is not scheduled or run manually, data is still continuously sent to the target once replication is configured on the source DXi. This can potentially fill up the target DXi.

---

**i Note:** To limit the amount of network bandwidth used for replication, enable a constant throttle (see [Enabling System Throttling on page 288](#)), or schedule replication throttling (see [Scheduling Replication Throttling on page 301](#)).

### Task Overview: Setting Up and Performing Directory/File or Cartridge Based Replication

To automatically replicate files or cartridges from a source system and immediately recover them for use on a target system:

1. Perform the following steps on the target system:
  - a. Add the source system to the list of allowed replication sources (see [Adding a Replication Source on page 290](#)).
  - b. Create a new share or partition with deduplication enabled (see [Adding a NAS Share on page 218](#) or [Adding a VTL Partition on page 233](#)).
  - c. Enable Directory/File or Cartridge Based Replication for the new share or partition and specify the Sync ID (see or [Configuring Directory/File or Cartridge Based Replication on page 149](#)).
2. Perform the following steps on the source system:
  - a. Specify the target system that will receive replicated data (see [Adding a Replication Target on page 284](#)).
  - b. Create a new share or partition with deduplication enabled (see [Adding a NAS Share on page 218](#) or [Adding a VTL Partition on page 233](#)).
  - c. Enable Directory/File or Cartridge Based Replication for the new share or partition and specify the Sync ID (see [Configuring Directory/File or Cartridge Based Replication on page 149](#)).

A file is automatically replicated when it is closed or a period of time after it is modified. A cartridge is automatically replicated after it is unmounted. After replication, the replicated files or cartridges are immediately available on the target system. There is no need to recover the share or partition to make the files or cartridges available.

---

**⚠ Caution:** Cartridge barcodes for all source systems that are replicating to the same target must be unique.

---

**i Note:** To limit the amount of network bandwidth used for replication, enable a constant throttle (see [Enabling System Throttling on page 288](#)), or schedule replication throttling (see [Scheduling Replication Throttling on page 301](#)).

### Task Overview: Recovering a Replicated Share or Partition

If a NAS share or VTL partition is lost or damaged on the source system, you can recover it on the target system using a received snapshot. When you recover a share or partition, it is recreated on the target system just as it was at the point in time when the snapshot was saved.

To recover a replicated share or partition:

1. On the target system, select a received snapshot and perform a recover operation (see [Recovering a Share on page 155](#) or [Recovering a Partition on page 165](#)).  
The share or partition is now available on the target system.
2. (Optional) Map your backup application to the recovered share or partition on the target system to continue making backups.
3. When the source system is operating correctly again, choose one of the following actions:
  - Failback the share or partition to restore it on the original source system (see [Task Overview: Performing a Share or Partition Failback below](#)). Then, if necessary, map your backup application to the restored share or partition on the original source system.
  - Continue to make backups to the recovered share or partition on the original target system. In addition, set up replication to replicate the share or partition back to the original source system (see [Task Overview: Setting Up and Performing Replication on page 142](#)). In this scenario, the original source system is now the target, and the original target system is now the source.

### Task Overview: Performing a Share or Partition Failback

If a NAS share or VTL partition is lost or damaged on the source system, you can failback the share or partition to the source system using a received snapshot on the target system. When you failback a share or partition, it is restored on the source system just as it was at the point in time when the snapshot was saved.

To perform a share or partition failback:

1. On the original source system, add the original target system to the list of allowed replication sources (see [Adding a Replication Source on page 290](#)).

---

**i Note:** For the purposes of failback, the original source system is now acting as a target because it will receive the snapshot from the original target system.

2. On the original target system, select a received snapshot and perform a failback operation pointing to the original source system, and then recover the share or partition on the original source system (see [Performing a Failback For a Share on page 156](#) or [Performing a Failback For a Partition on page 166](#)).

The share or partition is now available on the original source system.

3. (Optional) If necessary, map your backup application to the restored share or partition on the original source system.



# Replication Send

The **Replication Send** page allows you to manage outgoing replication activity for NAS shares or VTL partitions. You can replicate shares or partitions on the DXi6900 (the source) to other DXi systems (the targets). You can also schedule replication, and view the status of current and recent replication jobs.

**Note:** Before you can replicate shares or partitions, you must specify a replication target (see [Adding a Replication Target on page 284](#)).

To access the **Replication Send** page, click the **Replication** menu, and then click the **Send** tab (see [Figure 86 below](#)).

**Figure 86:** Replication Send Page

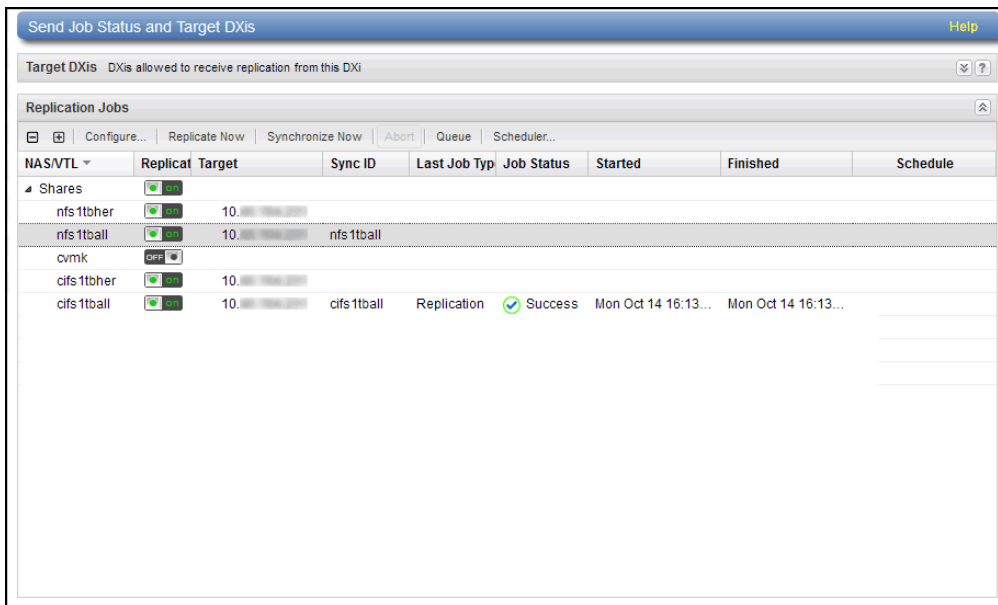

## Tasks

Use the **Replication Send** page to perform the following tasks:

- View replication information for shares or partitions (see [Replication Jobs List on the next page](#)).
- Enable or disable replication for a share or partition (see [Enabling Replication For a Share or Partition on page 148](#)).
- Configure Directory/File or Cartridge Based Replication for a share or partition (see [Configuring Directory/File or Cartridge Based Replication on page 149](#)).
- Initiate replication for a share or partition (see [Replicating a Share or Partition on page 151](#)).

- Synchronize a share or partition configured for Directory/File or Cartridge Based Replication (see [Synchronizing a Share or Partition on page 151](#)).
- View replication statistics for a share or partition configured for Directory/File or Cartridge Based Replication (see [Directory/File or Cartridge Based Replication Queue on page 152](#)).
- Schedule a share or partition for replication (see [Scheduling a Share or Partition For Replication on page 153](#)).
- Manage replication targets (see [Target DXis List on page 153](#))

## Replication Jobs List

The **Replication Jobs** list displays replication statistics for all NAS shares or VTL partitions on the DXi6900 that are eligible for replication. To be eligible for replication, a share or partition must have data deduplication enabled at the time it is created.

**i Note:** For information about creating NAS shares or VTL partitions, (see [Adding a NAS Share on page 218](#) or [Adding a VTL Partition on page 233](#)).

The **Replication Jobs** list displays the following information:

**i Note:** Click the arrow next to **Shares** or **Partitions** to display all shares or partitions in the list. Alternately, click the plus [ + ] or minus [ - ] icons to show or hide all shares or partitions.

- **NAS/VTL** - The name of the share or partition. Hold the cursor over the name to display detailed information about the share or partition.

**i Note:** If multiple targets are configured for a share or partition, click the arrow next to the share or partition to view all targets.

- **Replication** - The replication state (**On** or **Off**). Click the toggle switch to turn replication on or off for the share or partition.

**i Note:** Clicking the toggle next to **Shares** or **Partitions** will turn replication on or off for all shares or partitions.

Replication Jobs Information	Description
<b>Target</b>	The hostname or IP address of the configured replication target. If the share or partition is configured to replicate to multiple targets, click the arrow next to the share or partition name to display all targets.
<b>Sync ID</b>	The Sync ID of the share or partition if Directory/File or Cartridge Based Replication is enabled.
<b>Last Job Type</b>	The type of the most recent replication job ( <b>Replication</b> or <b>Synchronization</b> ).

Replication Jobs Information	Description
<b>Job Status</b>	The status of the most recent replication job (see <a href="#">Replication and Synchronization Status below</a> ). Hold the cursor over the job status to display detailed job statistics.
<b>Started</b>	The time the most recent replication job was started.
<b>Finished</b>	The time the most recent replication job was completed.
<b>Schedule</b>	A watch icon displays if replication is scheduled for the share or partition, as well as the next scheduled event (see <a href="#">Scheduling a Share or Partition For Replication on page 153</a> ).

### Replication Jobs Customization

You can customize the appearance of the **Replication Jobs** list in the following ways:

- Click the top banner row of the list to collapse or expand the list.
- Click the arrow to the right of a column heading and select **Sort Ascending** or **Sort Descending** to sort the rows in the table by that column.
- To show or hide a column, click the arrow to the right of a column heading, and then click **Columns**. Select the check box to show a column, or clear the check box to hide a column. (The following columns are hidden by default: **Original Data Size**, **Actual Data Sent**, and **Average Data Sent**.)
- To filter content in a column, click the arrow to the right of a column heading, and then click **Filters**. Type or select the desired filter. (If one row for a share or partition matches the filter, all rows for the share or partition are displayed.)

### Replication and Synchronization Status

A replication job can have one of the following statuses:

<b>In Progress</b>	The replication job is in progress.
<b>Partial</b>	A replication job was partially completed. Generate a replication report to see the files that were not replicated (see <a href="#">Reports on page 176</a> ).
<b>Queued</b>	The replication job is queued and will continue when the system is ready.
<b>Success</b>	The replication job was completed successfully.
<b>Failed</b>	The replication job was not completed.

A synchronization job can have one of the following statuses:

---

<b>Queued</b>	The synchronization job is queued and will continue when the system is ready.
<b>Success</b>	The synchronization job was completed successfully.
<b>Recovering</b>	The recover operation is in process.
<b>Replicating</b>	The replication operation is in process.
<b>Failed</b>	The synchronization job was not completed.

---

## Enabling Replication For a Share or Partition

Enable replication for a NAS share or VTL partition to allow the data on the share or partition to be replicated to other DXi systems (the targets). Disable replication if you do not want to replicate the share or partition to other DXi systems.

**Note:** To be eligible for replication, a share or partition must have data deduplication enabled at the time it is created.

To enable or disable replication for a share or partition:

1. Select the share or partition and click **Configure**.

The **Share or Partition Configure** window displays (see [Figure 87 below](#)).

**Figure 87:** Share or Partition Configure Window

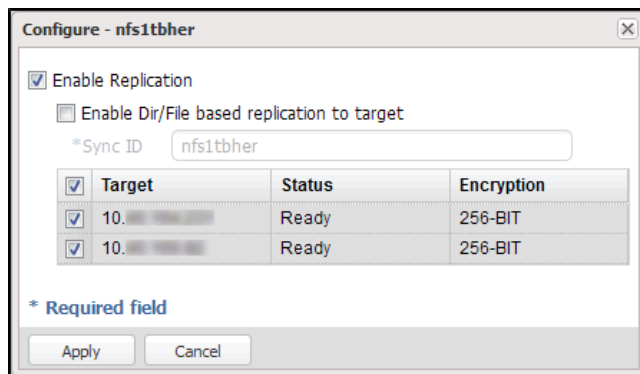

2. Select the **Enable Replication** check box to enable replication for the share or partition.
3. Or clear the **Enable Replication** check box to disable replication for the share or partition. Any jobs from that share or partition that are in progress or queued will transition to failure. Also, all replication job history for that combination of target and share or partition will be removed.
4. Select the check box for each replication target you want to replicate the share or partition to. (You must select at least one target.) When the share or partition is replicated, its data will be sent to all selected targets.
5. Click **Apply**.

### Additional Information

- Quantum recommends scheduling replication to run after backups are complete (see [Scheduling a Share or Partition For Replication on page 153](#)). If you do not enable scheduled replication, replication will only occur if you manually replicate a share or partition (see [Replicating a Share or Partition on page 151](#)) or if you configure Directory/File Based Replication (see [Configuring Directory/File or Cartridge Based Replication below](#)).
- Disabling replication for a share or partition does not delete any scheduled replication events for that share or partition. If you no longer want to schedule the share or partition for replication, manually delete the schedule (see [Deleting a Scheduled Event on page 304](#)).

## Configuring Directory/File or Cartridge Based Replication

Configure a NAS share or VTL partition for Directory/File or Cartridge Based Replication to automatically replicate files or cartridges to other DXi systems (the targets). A file is automatically replicated when it is closed or a period of time after it is modified. A cartridge is automatically replicated when it is unmounted. After replication, the replicated files or cartridges are immediately available on the target systems. There is no need to recover the share or partition to make the files or cartridges available. Disable Directory/File or Cartridge Based Replication if you do not want to automatically replicate files or cartridges.

When you configure a share or partition for Directory/File or Cartridge Based Replication, you must specify a Sync ID. The Sync ID associates the share or partition on the source system with the share or partition on the target systems that will receive the replicated data. The **Sync ID** for the source share or partition must match the **Sync ID** for the target share or partition.

If Cartridge Based Replication is enabled for a VTL partition, the following media behaviors apply:

- When a cartridge is exported from the partition, the cartridge is deleted from the configured target systems.
- When a cartridge is imported into the partition, the cartridge is replicated to the configured target systems.
- When a cartridge is deleted on a source system, it is in the **Unassigned** partition, thus this action has no effect on Cartridge Based Replication activity.

To configure a source share or partition for Directory/File or Cartridge Based Replication:

1. If you have not already done so, configure the target share or partition on the target DXi (see [Configuring a Target Share for Directory/File Based Replication on page 162](#) or [Configuring a Target Partition for Cartridge Based Replication on page 172](#).)
2. On the source DXi, select the source share or partition and click **Configure**.

The **Share or Partition Configure** window displays (see [Figure 88 on the next page](#)).

**Figure 88:** Share or Partition Configure Window

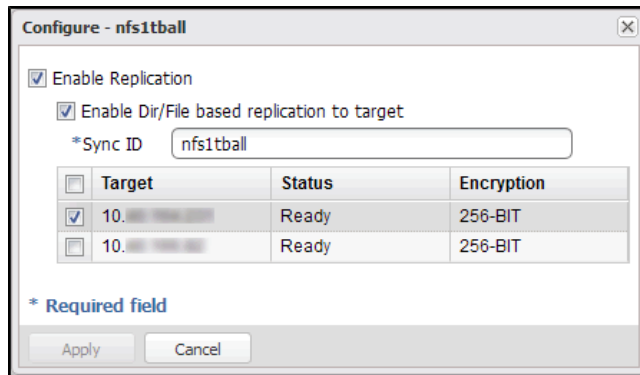

3. If it is not already selected, select the **Enable Replication** check box to enable replication for the share or partition.
4. Select the **Enable Directory/File or Cartridge Based Replication to target** check box to enable Directory/File or Cartridge Based Replication for the share or partition.

Or clear the **Enable Directory/File or Cartridge Based Replication to target** check box to disable Directory/File or Cartridge Based Replication for the share or partition.

5. Enter a **Sync ID** in the box.

The **Sync ID** is used to identify the target share or partition that will receive replicated data from the source share or partition. The **Sync ID** must be identical to the **Sync ID** of the target share or partition on the target system.

The **Sync ID** must contain no more than 32 characters (NAS share) or 12 characters (VTL partition) and can contain only alphanumeric characters, underscores, and hyphens. (An underscore or hyphen must not be the first character.)

---

**i Note:** If you are performing Directory/File or Cartridge Based Replication with a system running a DXi software version prior to 2.3, you may need to change the **Sync ID** on the system running pre-2.3 software to match the above **Sync ID** name restrictions.

6. Select the check box for each replication target you want to replicate the share or partition to. (You must select at least one target.) When the share or partition is replicated, its data will be sent to all selected targets.

---

**i Note:** Directory/File or Cartridge Based Replication will be configured for all selected targets. You cannot configure one share or partition for multiple replication types.

7. Click **Apply**.

---

**i Note:** After you configure a share or partition for Directory/File or Cartridge Based Replication, you should synchronize it to ensure it is in sync with the target share or partition (see [Synchronizing a Share or Partition on the next page](#)).

## Replicating a Share or Partition

Replicate a NAS share or VTL partition to send a snapshot of the share or partition to the target systems. A snapshot is required to recover the data on the targets at a later time. If you have not configured a replication schedule for a share or partition, replication only occurs when you manually initiate it (see ).

---

**⚠ Caution:** Do not replicate a partition containing media in an **Exported** state.

To replicate a share or partition:

1. Select the share or partition to replicate.

If multiple targets are configured, click the arrow next to the share or partition to display all targets, and then select the desired target.

2. Click **Replicate Now**.

The status of the replication job displays in the **Job Status** column.

To cancel the replication job, select the share or partition and click **Abort**.

## Synchronizing a Share or Partition

Synchronize a NAS share or VTL partition to synchronize its contents with the corresponding share or partition on the target systems. To synchronize a share or partition, it must be configured for Directory/File or Cartridge Based Replication (see [Configuring Directory/File or Cartridge Based Replication on page 149](#)).

Synchronizing a share or partition ensures that the contents of the source share or partition are the same as the target share or partition. The synchronization verifies that the same files or cartridges exist in both locations, and that no additional files or cartridges exist in either location.

You should perform a synchronization in any of the following situations:

- When Directory/File or Cartridge Based Replication is first enabled for a share or partition.
- If a Directory/File or Cartridge Based Replication job fails.
- If Directory/File or Cartridge Based Replication is disabled for a time and then is re-enabled.

Manually performing a synchronization is not necessary except in the cases described above. When synchronization is manually initiated for a share or partition, the replication queue for that share or partition is cleared. All file write and delete requests are queued after the synchronization, and they are not processed until the synchronization is complete. This can cause replication to appear to be slow, especially for a share or partition that is frequently accessed.

---

**⚠ Caution:** Before synchronizing a share or partition, make sure all media are unmounted and there are no active backup jobs to the share or partition. (After the synchronization reaches the **Replicating** state, backup jobs are allowed.)

---

**i Note:** Even when replication is paused, the system continues to queue Directory/File or Cartridge Based Replication operations. Each time an operation is queued, the system logs an administration alert that reports the total number of queued Directory/File or Cartridge Based Replication requests.

**i Note:** If a synchronization fails, make sure the target share or partition is unlocked (see [Configuring a Target Share for Directory/File Based Replication on page 162](#) or [Configuring a Target Partition for Cartridge Based Replication on page 172](#)).

To synchronize a share or partition:

1. Select the share or partition to synchronize.

If multiple targets are configured, click the arrow next to the share or partition to display all targets, and then select the desired target.

2. Click **Synchronize Now**.

The status of the synchronization job displays in the **Job Status** column.

To cancel the synchronization job, select the share or partition and click **Abort**.

## Directory/File or Cartridge Based Replication Queue

The Directory/File or Cartridge Based Replication displays replication statistics for shares or partitions that are configured for Directory/File or Cartridge Based Replication (see [Configuring Directory/File or Cartridge Based Replication on page 149](#)).

To view the Directory/File or Cartridge Based Replication Queue:

1. Select a share or partition that is configured for Directory/File or Cartridge Based Replication.

If multiple targets are configured, click the arrow next to the share or partition to display all targets, and then select the desired target.

2. Click **Queue**.

The Directory/File or Cartridge Based Replication Queue displays the following information for the share or partition:

<b>File/Directory or Barcode</b>	The file/directory or cartridge to be replicated.
<b>State</b>	The replication state for the file/directory or cartridge.
<b>Progress</b>	The percentage complete for replication of the file/directory or cartridge.
<b>Estimated Duration</b>	The estimated time it will take to complete replication for the file/directory or cartridge. <b>i Note:</b> The estimated duration may display as unknown if replication has been very recently initiated. After the system has enough information to calculate a value, the estimated duration will display.

### Additional Information

- The contents of the Directory/File or Cartridge Based Replication Queue are dynamic. Because of this, statistics are subject to change if items are added to the queue.



- The queue may show a large number of deletion entries after a single directory is deleted. This is expected behavior, and occurs because several recursive file or subdirectory deletions may be required.

3. To close the Directory/File or Cartridge Based Replication Queue, click the Close icon.

## Scheduling a Share or Partition For Replication

When a share or partition is enabled for replication, it is important to regularly replicate the share or partition to the target systems. Quantum recommends scheduling replication to run after backups are complete.

To schedule a share or partition for replication, click **Scheduler**. The **Scheduler** window displays (see [Figure 89 below](#)).

For details about using the **Scheduler** to add or edit a replication schedule, see [Scheduling a Share or Partition for Replication on page 300](#).

**Figure 89:** Scheduler Window

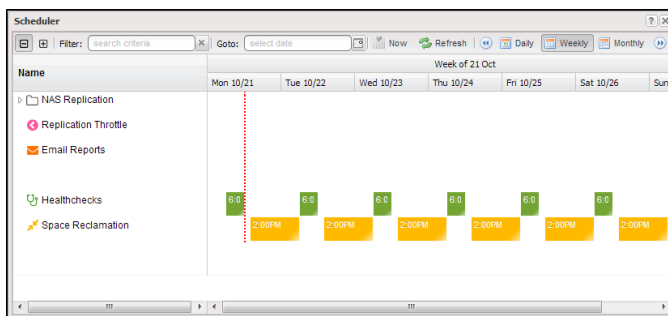

## Target DXIs List

The **Target DXIs** list allows you to configure and manage replication targets on the DXi6900. Click the arrows at the upper right, or click the top banner row, to expand or collapse the **Target DXIs** list.

---

# Receive NAS

The **Receive NAS** page allows you to manage incoming replication activity for NAS shares. You can recover a replicated share on the target system if the source system is unavailable. Once the source system becomes available, you can failback the share to make it available on the source system again.

**Note:** Before you can receive replicated shares, you must specify one or more replication sources (see [Adding a Replication Target on page 284](#)).

To access the **Receive NAS** page, click the **Replication** menu, and then click the **Receive > NAS** tab.

### Tasks

Use the **Receive NAS** page to perform the following tasks:

- View received snapshots and recover, failback, or delete snapshots (see [Received Snapshots below](#)).
- Manage recovery jobs (see [Recovery Jobs on page 158](#)).
- Manage failback jobs (see [Failback Jobs on page 159](#)).
- Manage shares configured for Directory/File Based Replication (see [Directory/File Based on page 160](#)).

## Received Snapshots

The **Received Snapshots** page allows you to view and work with received snapshots. When a replicated NAS share is received from a source system, it is saved as a snapshot. The snapshot contains all of the data necessary to fully recover or failback the share to the point in time when the snapshot was saved.

To access the **Received Snapshots** page, on the **Receive NAS** page, click the **Received Snapshots** tab (see [Figure 90 below](#)).

**Figure 90:** Received Snapshots Page

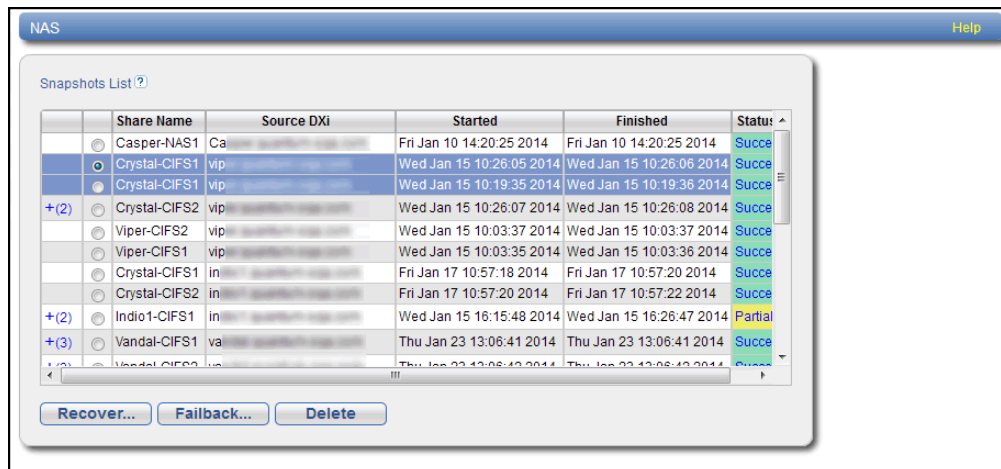

### Tasks

Use the **Received Snapshots** page to perform the following tasks:

- View information about received snapshots (see [Snapshots List on the next page](#)).
- Recover a partition on the target system (see [Recovering a Share on the next page](#)).

- Failback a partition to the source system (see [Performing a Failback For a Share on the next page](#)).
- Delete a received snapshot (see [Deleting a Snapshot on page 158](#)).

**i Note:** The target system will retain up to 10 replication snapshots (default setting) for each replicated partition. Once 10 snapshots have been saved, the oldest snapshot is deleted to make room for each new snapshot that is received. (To change the maximum number of snapshots retained for each partition, see [Changing the Maximum Number of Snapshots on page 291](#)).

## Snapshots List

The **Snapshots List** displays all available snapshots that have been received from configured replication sources. Snapshots are grouped by NAS Share. To see all available snapshots for a partition, click the plus icon **[+]** next to the share name.

The **Snapshots List** displays the following information about each snapshot:

<b>Share Name</b>	The name of the share.
<b>Source DXi</b>	The hostname of the system that the snapshot was sent from.
<b>Started</b>	The time the most recent replication job was started.
<b>Finished</b>	The time the most recent replication job finished.
<b>Status</b>	The status of the most recent replication job (see <a href="#">Replication and Synchronization Status on page 147</a> ). Click the status to display detailed information about the most recent replication job.

**i Note:** Click a column heading to sort the rows in the table by that column. Click the column heading again to reverse the sort order.

## Recovering a Share

Recover a NAS share if the source system is unavailable and you need to access the share (for example, to continue performing backups). When you recover a share, you select a received snapshot. The DXi6900 uses the snapshot to recreate the share on the target system just as it was at the point in time when the snapshot was saved.

**i Note:** Before recovering a share, you must enable CIFS/SMB on the DXi (see [Windows Domain on page 223](#)). Also, if the DXi is not using Active Directory, you must configure at least one workgroup user to own recovered CIFS/SMB shares (see [Share Access on page 225](#)).

To recover a share:

1. On the target system, select a snapshot in the **Snapshots List** and click **Recover**.  
The **Recovered Share Name** page displays (see [Figure 91 below](#)).

**Figure 91:** Recovered Share Name Page

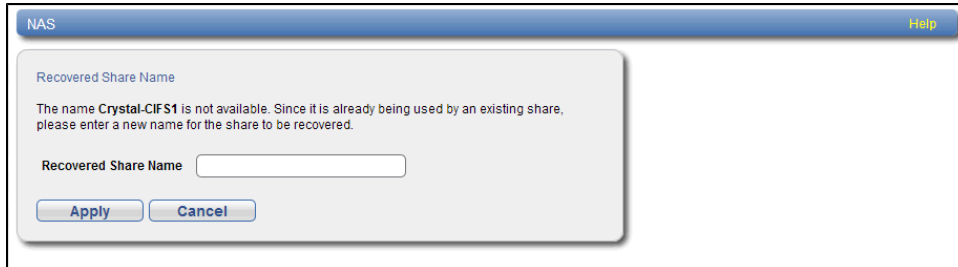

2. (Optional) In the **Recovered Share Name** box, type a new name for the recovered share. (The default name is the original share name.)
3. Click **Apply**.

The share is recovered on the target system. All data stored on the share at the time the snapshot was saved is available. The original export protocol of the share (NFS or CIFS/SMB) is retained in the recovery process.

---

**i Note:** After you recover a share, if you want to continue backing up data to the share, you must remap your backup application to point to the target system instead of the source system.

### Performing a Failback For a Share

Perform a failback of a NAS share if a source system that was previously unavailable becomes available again. When you failback a share, you select a received snapshot. The DXi6900 copies the snapshot from the target system back to the source system. You can then perform a recover operation to recreate the share on the source system just as it was at the point in time when the snapshot was saved.

---

**i Note:** Before you can failback a share, on the original source system, you must add the original target system to the list of allowed replication sources (see [Adding a Replication Source on page 290](#)). This is because, during failback, the original target is acting as a source when it sends a snapshot to the original source.

1. To perform a share failback:  
On the target system, select a snapshot in the **Snapshots List** and click **Failback**.  
The **Failback Target** page displays (see [Figure 92 on the next page](#)).

**Figure 92:** Failback Target Page

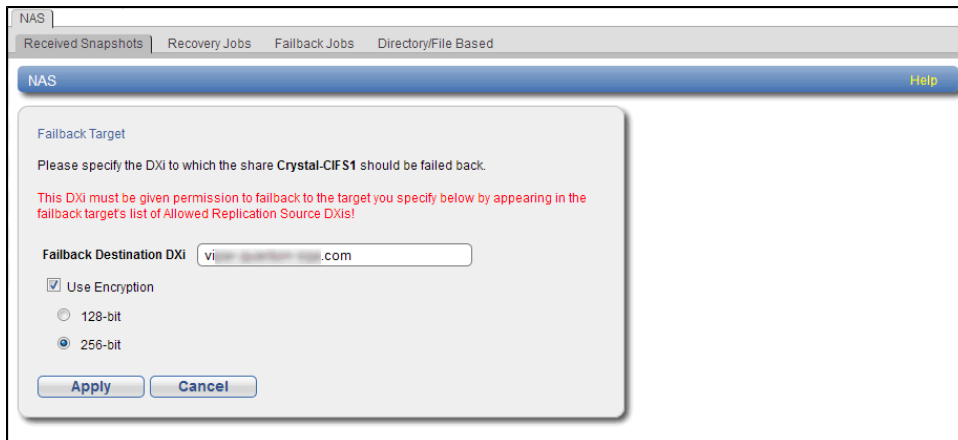

- (Optional) In the **Failback Destination DXi** box, type the hostname or IP address of a new destination system to failback the partition to. (The default destination is the original source system.)

---

**i Note:** To use hostname format, you must specify at least one DNS IP address on the **Network** page (see [Network on page 322](#)).

- (Optional) Leave the **Use Encryption** check box selected to enable encryption when sending the snapshot to the destination. Or clear the **Use Encryption** check box to disable encryption when sending the snapshot to the destination.

---

**! Caution:** Select 128-bit encryption if you are sending data to a DXi running a system software version prior to DXi 2.1 Software.

---

**i Note:** AES encryption options are available only if the Data-in-Flight license is installed (see [License Keys on page 377](#)).

- Click **Apply**.

The snapshot is sent to the source system.

- On the source system, in the **Snapshots List**, select the snapshot that was sent during the failback operation and click **Recover**.

The **Recovered Partition Name** page displays.

- (Optional) In the **Recovered Partition Name** box, type a new name for the recovered share. (The default name is the original share name.)

- Click **Apply**.

The share is recovered on the source system. All data stored on the share at the time the snapshot was saved is available. The original export protocol of the share (NFS or CIFS/SMB) is retained in the recovery process.

- 
- i Note:** If you previously remapped your backup application to a recovered share on the target system, after you failback the share, you must remap your backup application again to point to the source system.

## Deleting a Snapshot

Delete a snapshot if it is no longer needed. After you delete a snapshot, it can no longer be used to recover or failback a NAS share.

- 
- i Note:** You cannot delete a snapshot if a failback operation is in progress for the snapshot. Wait for the failback operation to complete, or abort the operation (see ).

To delete a snapshot:

1. Do one of the following actions:
  - **On the source system, disable replication for the share associated with the snapshot (see [Enabling Replication For a Share or Partition on page 148](#)).**
  - On the target system, delete the source system associated with the snapshot from the list of allowed replication sources (see [Deleting a Replication Source on page 2918](#)).
2. On the target system, select a snapshot in the **Snapshots List** and click **Delete**.

- 
- i Note:** If you delete the last snapshot for a partition while replication for the partition (to this target) is still enabled, any replicated data not yet protected by a replicated share is *not* deleted. To delete this data, on the source system, disable replication for the partition before deleting the last snapshot.

3. Click **Yes** to confirm the action.

## Recovery Jobs

The **Recovery Jobs** page allows you to view information about snapshot recover operations that were previously completed.

To access the **Recovery Jobs** page, on the **Receive NAS** page, click the **Recovery Jobs** tab (see [Figure 93 on the next page](#)).

**Figure 93:** Recovery Jobs Page

	Original Share Name	New Share Name	Source DXi	Started	Finished	Status
<input type="radio"/>	Viper-CIFS2	Viper-CIFS2	vip	Wed Jan 15 10:08:28 2014	Wed Jan 15 10:08:31 2014	Success
<input type="radio"/>	Viper-CIFS1	Viper-CIFS1	vip	Wed Jan 15 10:09:09 2014	Wed Jan 15 10:09:12 2014	Success
<input type="radio"/>	Crystal-CIFS1	CrystCIFS1	ind	Fri Jan 17 11:24:19 2014	Fri Jan 17 11:24:23 2014	Success
<input type="radio"/>	Indio1-CIFS1	Indio1-CIFS1	ind	Wed Jan 15 12:07:42 2014	Wed Jan 15 12:07:46 2014	Success
<input type="radio"/>	Vandal-CIFS1	Vandal-CIFS1	var	Thu Jan 23 11:04:39 2014	Thu Jan 23 11:04:43 2014	Success
<input type="radio"/>	Vandal-CIFS2	Vandal-CIFS2	var	Thu Jan 23 11:04:57 2014	Thu Jan 23 11:05:01 2014	Success
<input type="radio"/>	v4000-CIFS1	v4000-CIFS1	DX100	Thu Jan 16 10:58:27 2014	Thu Jan 16 10:58:30 2014	Success
<input type="radio"/>	Crystal-CIFS1	Crystal-CIFS1	Crys	Wed Jan 22 15:59:35 2014	Wed Jan 22 15:59:41 2014	Success
<input type="radio"/>	Crystal-CIFS2	Crystal-CIFS2	Crys	Wed Jan 22 15:59:50 2014	Wed Jan 22 15:59:56 2014	Success
<input type="radio"/>	blue3	blue3	Aqu	Thu Jan 9 15:53:24 2014	Thu Jan 9 15:53:29 2014	Success
<input type="radio"/>	blue1	blue1-rec4	Aqu	Fri Jan 10 06:23:44 2014	Fri Jan 10 06:23:50 2014	Success

Delete Job Info

The **Snapshot Recovery Jobs** section displays the following information about recovery jobs:

<b>Original Share Name</b>	The name of the share the snapshot was created from.
<b>New Share Name</b>	The name of the share the snapshot was recovered to.
<b>Source DXi</b>	The hostname of the system that the snapshot was received from.
<b>Started</b>	The time the recovery job was started.
<b>Finished</b>	The time the recovery job finished.
<b>Status</b>	The status of the recovery job ( <b>Success</b> , <b>In Progress</b> , or <b>Failed</b> ).

To delete information for a recovery job, select it in the **Snapshot Recovery Jobs** list and click **Delete Job Info**.

## Failback Jobs

The **Failback Jobs** page allows you to view information about snapshot failback operations that were previously completed. You can also abort a failback that is currently in progress.

To access the **Failback Jobs** page, on the **Receive NAS** page, click the **Failback Jobs** tab (see [Figure 94 on the next page](#)).

Figure 94: Failback Jobs Page

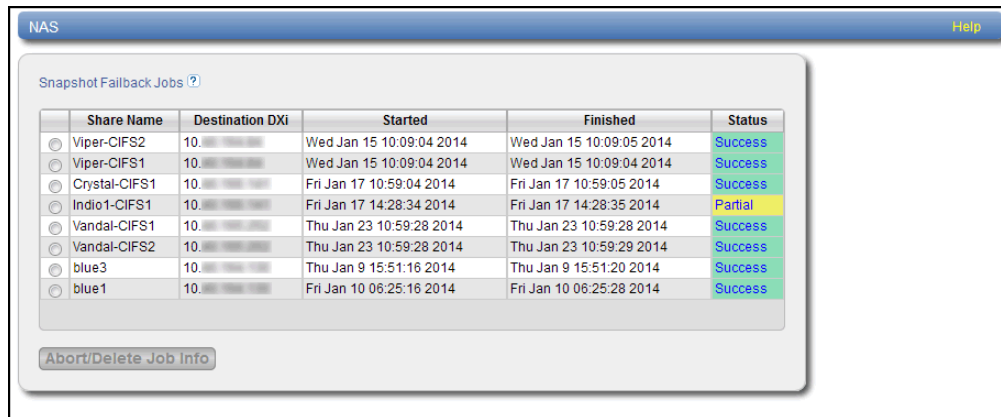

The screenshot shows a web interface titled "NAS" with a "Help" link. Below the title is a section for "Snapshot Failback Jobs" with a help icon. A table lists several failback jobs with columns for Share Name, Destination DXi, Started, Finished, and Status. The status column uses color coding: green for Success, yellow for Partial, and red for Failed. A button labeled "Abort/Delete Job Info" is located at the bottom of the table.

	Share Name	Destination DXi	Started	Finished	Status
<input type="radio"/>	Viper-CIFS2	10.10.10.10	Wed Jan 15 10:09:04 2014	Wed Jan 15 10:09:05 2014	Success
<input type="radio"/>	Viper-CIFS1	10.10.10.10	Wed Jan 15 10:09:04 2014	Wed Jan 15 10:09:04 2014	Success
<input type="radio"/>	Crystal-CIFS1	10.10.10.10	Fri Jan 17 10:59:04 2014	Fri Jan 17 10:59:05 2014	Success
<input type="radio"/>	Indio1-CIFS1	10.10.10.10	Fri Jan 17 14:28:34 2014	Fri Jan 17 14:28:35 2014	Partial
<input type="radio"/>	Vandal-CIFS1	10.10.10.10	Thu Jan 23 10:59:28 2014	Thu Jan 23 10:59:28 2014	Success
<input type="radio"/>	Vandal-CIFS2	10.10.10.10	Thu Jan 23 10:59:28 2014	Thu Jan 23 10:59:29 2014	Success
<input type="radio"/>	blue3	10.10.10.10	Thu Jan 9 15:51:16 2014	Thu Jan 9 15:51:20 2014	Success
<input type="radio"/>	blue1	10.10.10.10	Fri Jan 10 06:25:16 2014	Fri Jan 10 06:25:28 2014	Success

The **Snapshot Failback Jobs** section displays the following information about failback jobs:

<b>Share Name</b>	The name of the share the snapshot was created from.
<b>Destination DXi</b>	The hostname of the system that the snapshot was sent to.
<b>Started</b>	The time the failback job was started.
<b>Finished</b>	The time the failback job finished.
<b>Status</b>	The status of the failback job ( <b>Success</b> , <b>In Progress</b> , or <b>Failed</b> ).

Use the **Failback Jobs** page to perform the following tasks:

- To delete information for a failback job, select it in the **Snapshot Failback Jobs** section and click **Delete Job Info**.
- To abort a failback job that is in progress, select it in the **Snapshot Failback Jobs** section and click **Abort**.

## Directory/File Based

The **Directory/File Based** page allows you to manage Directory/File Based Replication on the target system. You can configure a NAS share to receive Directory/File Based Replication data sent from a source system and view replication statistics for the share.

**Note:** For information about creating NAS shares, see [Adding a NAS Share on page 218](#).

To access the **Directory/File Based** page, on the **Receive NAS** page, click the **Directory/File Base** tab (see [Figure 95 on the next page](#)).



**Figure 95:** Directory/File Based Page

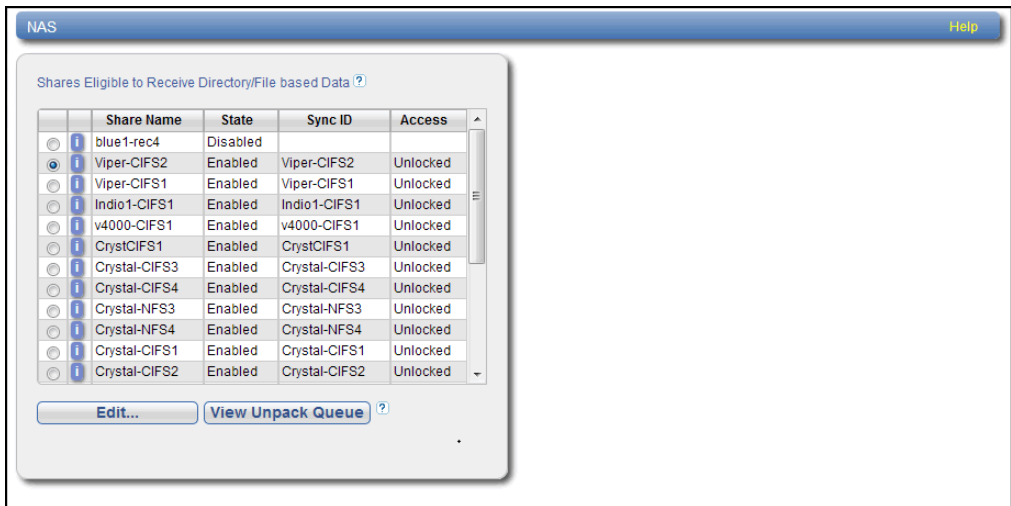

## Tasks

Use the **Directory/File Based** page to perform the following tasks:

- View shares eligible to receive Directory/File Based data (see [Shares Eligible to Receive Directory/File Based Data below](#))
- Configure a share to receive Directory/File Based data (see [Configuring a Target Share for Directory/File Based Replication on the next page](#))
- View statistics for shares configured for Directory/File Based Replication (see [Unpack Queue on page 163](#))

## Shares Eligible to Receive Directory/File Based Data

The **Shares Eligible to Receive Directory/File Based Data** section displays information for all NAS shares on the DXi6900 that are eligible to receive Directory/File Based Replication data from a source share. To be eligible to receive Directory/File Based Replication data, a share must have data deduplication enabled at the time it is created.

The **Shares Eligible for Replication** section displays the following information:

<b>Share Name</b>	The name of the share.
<b>State</b>	The state of Directory/File Based Replication for the share ( <b>Enabled</b> or <b>Disabled</b> ).
<b>Sync ID</b>	The Sync ID used to identify the source share that will send replicated data to the share.
<b>Access</b>	The selected access option for the share ( <b>Locked</b> or <b>Unlocked</b> ).

**i Note:** Click the Information button **[i]** next to a partition to display detailed information about the share and recent replication activity.

## Configuring a Target Share for Directory/File Based Replication

Configuring a NAS share for Directory/File Based Replication enables the automatic replication of files and directories on the source partition to the target share. Before you configure a share on the source system for Directory/File Based Replication, you must configure a share on the target system to receive the replicated data from the source share.

**i Note:** For information about configuring Directory/File Based Replication on the source system, see [Configuring Directory/File or Cartridge Based Replication on page 149](#).

To configure a target share for Directory/File Based Replication:

1. Select the share and click **Edit**.

The **Edit Share Settings** page displays (see [Figure 96 below](#)).

**Figure 96:** Edit Share Settings Page

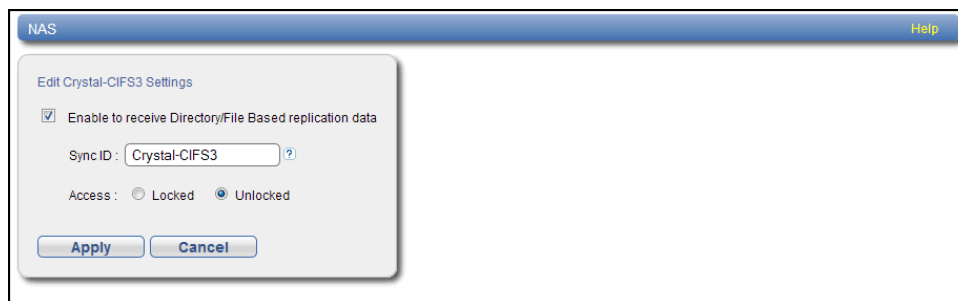

2. Select the **Enable to receive Directory/File Based replication data** check box to enable Directory/File Based Replication for the share.

Or clear the **Enable to receive Directory/File Based replication data** check box to disable Directory/File Based Replication for the share.

3. Enter a **Sync ID** in the box.

The Sync ID is used to identify the source share that will send replicated data to the target partition. The Sync ID *must* be identical to the Sync ID of the source share on the source system.

4. Select an **Access** option:
  - **Locked** - The share is not allowed to receive new Directory/File Based Replication data.
  - **Unlocked** - The share is allowed to receive new Directory/File Replication data.

**i Note:** If a share configured for Directory/File Based Replication is locked on the target system, synchronization jobs may fail on the source system.

5. Click **Apply**.

## Unpack Queue

Use the **Unpack Queue** to view Directory/File Replication statistics for data received from the source system.

To view the **Unpack Queue**, select a share and click **View Unpack Queue** (see [Figure 97 below](#)).

**Figure 97:** Unpack Queue

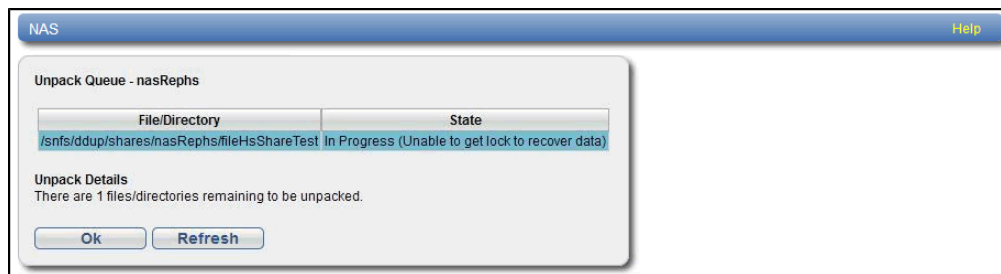

The **Unpack Queue** displays the following information:

<b>Barcode</b>	The barcode of the file or directory to be replicated.
<b>State</b>	The replication state of the file or directory.

Click **Refresh** to update the statistics in the Unpack Queue. Click **OK** to return to the **Directory/File Based** page.

---

# Receive VTL

The **Receive VTL** page allows you to manage incoming replication activity for VTL partitions. You can recover a replicated partition on the target system if the source system is unavailable. Once the source system becomes available, you can failback the partition to make it available on the source system again.

**i Note:** Before you can receive replicated partitions, you must specify one or more replication sources (see [Adding a Replication Source on page 290](#)).

To access the **Receive VTL** page, click the **Replication** menu, and then click the **Receive > VTL** tab.

## Tasks

Use the **Receive VTL** page to perform the following tasks:

- View received snapshots and recover, failback, or delete snapshots (see [Received Snapshots below](#)).
- Manage recovery jobs (see [Recovery Jobs on page 168](#)).
- Manage failback jobs (see [Failback Jobs on page 169](#)).
- Manage shares configured for Cartridge Based Replication (see [Cartridge Based on page 170](#)).

## Received Snapshots

The **Received Snapshots** page allows you to view and work with received snapshots. When a replicated VTL partition is received from a source system, it is saved as a snapshot. The snapshot contains all of the data necessary to fully recover or failback the partition to the point in time when the snapshot was saved.

To access the **Received Snapshots** page, on the **Receive VTL** page, click the **Received Snapshots** tab (see [Figure 98 below](#)).

**Figure 98:** Received Snapshots Page

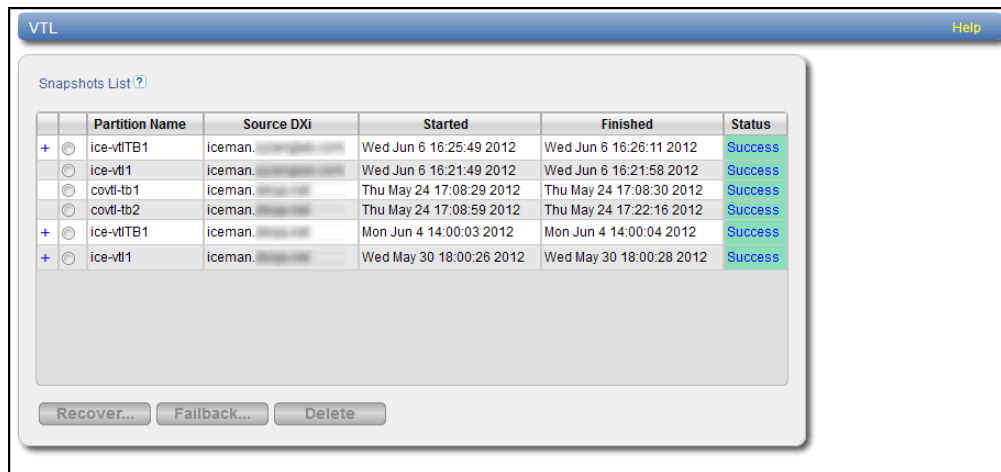

## Tasks

Use the **Received Snapshots** page to perform the following tasks:

- View information about received snapshots (see [Snapshots List on the next page](#)).
- Recover a partition on the target system (see [Recovering a Partition on the next page](#)).
- Failback a partition to the source system (see [Performing a Failback For a Partition on page 166](#)).
- Delete a received snapshot (see [Deleting a Snapshot on page 168](#)).

**i Note:** The target system will retain up to 10 replication snapshots (default setting) for each replicated partition. Once 10 snapshots have been saved, the oldest snapshot is deleted to make room for each new snapshot that is received. (To change the maximum number of snapshots retained for each partition, see [Changing the Maximum Number of Snapshots on page 291](#)).

## Snapshots List

The **Snapshots List** displays all available snapshots that have been received from configured replication sources. Snapshots are grouped by VTL partition. To see all available snapshots for a partition, click the plus icon **[+]** next to the partition name.

The **Snapshots List** displays the following information about each snapshot:

<b>Partition Name</b>	The name of the partition.
<b>Source DXi</b>	The hostname of the system that the snapshot was sent from.
<b>Started</b>	The time the most recent replication job was started.
<b>Finished</b>	The time the most recent replication job finished.
<b>Status</b>	The status of the most recent replication job (see <a href="#">Replication and Synchronization Status on page 147</a> ). Click the status to display detailed information about the most recent replication job.

**i Note:** Click a column heading to sort the rows in the table by that column. Click the column heading again to reverse the sort order.

## Recovering a Partition

Recover a VTL partition if the source system is unavailable and you need to access the partition (for example, to continue performing backups). When you recover a partition, you select a received snapshot. The DXi6900 uses the snapshot to recreate the partition on the target system just as it was at the point in time when the snapshot was saved.

**i Note:** To recover a partition, the target system must support the library emulation and drive type used in the original partition. For a list of the available library emulations and drive types on the target system, see [Adding a VTL Partition on page 233](#).

To recover a partition:

1. On the target system, select a snapshot in the **Snapshots List** and click **Recover**.

The **Recovered Partition Name** page displays (see [Figure 99 on the next page](#)).

**Figure 99:** Recovered Partition Name Page

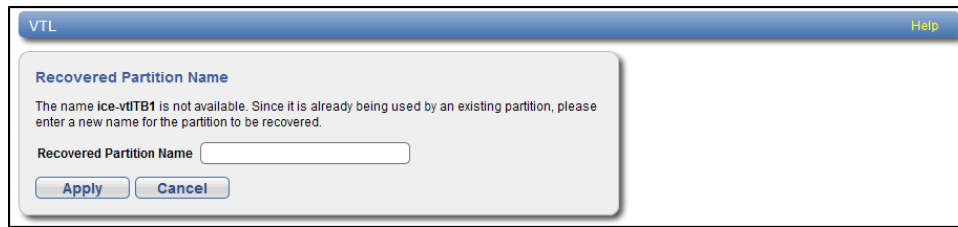

2. (Optional) In the **Recovered Partition Name** box, type a new name for the recovered partition. (The default name is the original partition name.)
3. Click **Apply**.

The partition and its cartridges are recovered on the target system. All data stored on the partition at the time the snapshot was saved is available.

After recovering the partition, you must add tape drives to the partition. The tape drive type must be identical to the original partition so that the media is compatible. In addition, you must map the devices before the VTL partition is accessible.

If the partition contains media, you will only be able to select the highest capacity tape drive for that media type. For example, if the partition contains SDLT600 tape cartridges, you will only be able to select DLT-S4 tape drives when mapping devices to the recovered partition.

#### Additional Information

- When a VTL partition is recovered on a target system, a new serial number is created for the partition.
- After you recover a partition, if you want to continue backing up data to the partition, you must remap your backup application to point to the target system instead of the source system.

#### Performing a Failback For a Partition

Perform a failback of a VTL partition if a source system that was previously unavailable becomes available again. When you failback a partition, you select a received snapshot. The DXi6900 copies the snapshot from the target system back to the source system. You can then perform a recover operation to recreate the partition on the source system just as it was at the point in time when the snapshot was saved.

**i Note:** Before you can failback a partition, on the original source system, you must add the original target system to the list of allowed replication sources (see [Adding a Replication Source on page 290](#)). This is because, during failback, the original target is acting as a source when it sends a snapshot to the original source.

1. To perform a partition failback:

On the target system, select a snapshot in the **Snapshots List** and click **Failback**.

The **Failback Target** page displays (see [Figure 100 below](#)).

**Figure 100:** Failback Target Page

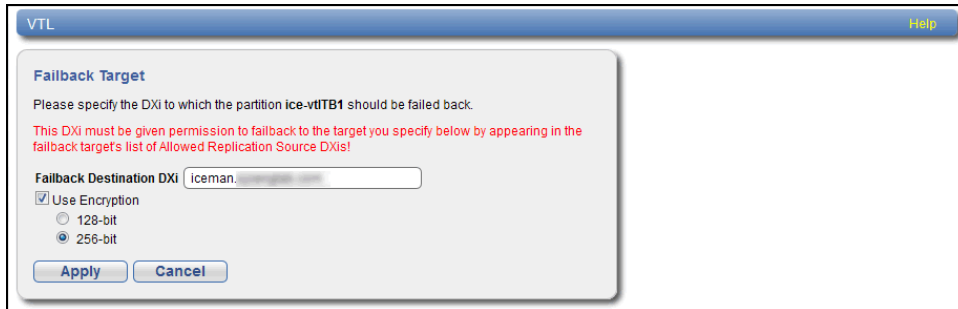

- (Optional) In the **Failback Destination DXi** box, type the hostname or IP address of a new destination system to failback the partition to. (The default destination is the original source system.)

---

**i Note:** To use hostname format, you must specify at least one DNS IP address on the **Network** page (see [Network on page 322](#)).

- (Optional) Leave the **Use Encryption** check box selected to enable encryption when sending the snapshot to the destination. Or clear the **Use Encryption** check box to disable encryption when sending the snapshot to the destination.

---

**! Caution:** Select 128-bit encryption if you are sending data to a DXi running a system software version prior to DXi 2.1 Software.

---

**i Note:** AES encryption options are available only if the Data-in-Flight license is installed (see [License Keys on page 377](#)).

- Click **Apply**.

The snapshot is sent to the source system.

- On the source system, in the **Snapshots List**, select the snapshot that was sent during the failback operation and click **Recover**.

The **Recovered Partition Name** page displays.

- (Optional) In the **Recovered Partition Name** box, type a new name for the recovered partition. (The default name is the original partition name.)

- Click **Apply**.

The partition and its cartridges are recovered on the source system. All data stored on the partition at the time the snapshot was saved is available.

After recovering the partition, you must add tape drives and a robot to the partition, and you must map the devices before the VTL partition is accessible. If the partition contains media, you will only be able to

select the highest capacity tape drive for that media type. For example, if the partition contains SDLT600 tape cartridges, you will only be able to select DLT-S4 tape drives when mapping devices to the recovered partition.

### Additional Information

- When a VTL partition is recovered on a target system, a new serial number is created for the partition.
- If you previously remapped your backup application to a recovered partition on the target system, after you failback the partition, you must remap your backup application again to point to the source system.

### Deleting a Snapshot

Delete a snapshot if it is no longer needed. After you delete a snapshot, it can no longer be used to recover or failback a VTL partition.

**i Note:** You cannot delete a snapshot if a failback operation is in progress for the snapshot. Wait for the failback operation to complete, or abort the operation (see [Failback Jobs on the next page](#)).

To delete a snapshot:

1. Do one of the following actions:
  - On the source system, disable replication for the partition associated with the snapshot (see [Enabling Replication For a Share or Partition on page 148](#)).
  - On the target system, delete the source system associated with the snapshot from the list of allowed replication sources (see [Deleting a Replication Source on page 291](#)).
2. On the target system, select a snapshot in the **Snapshots List** and click **Delete**.

**i Note:** If you delete the last snapshot for a partition while replication for the partition (to this target) is still enabled, any replicated data not yet protected by a replicated partition is *not* deleted. To delete this data, on the source system, disable replication for the partition before deleting the last snapshot.

3. Click **Yes** to confirm the action.

## Recovery Jobs

The **Recovery Jobs** page allows you to view information about snapshot recover operations that were previously completed.

To access the **Recovery Jobs** page, on the **Receive VTL** page, click the **Recovery Jobs** tab (see [Figure 101 on the next page](#)).



**Figure 101:** Recovery Jobs Page

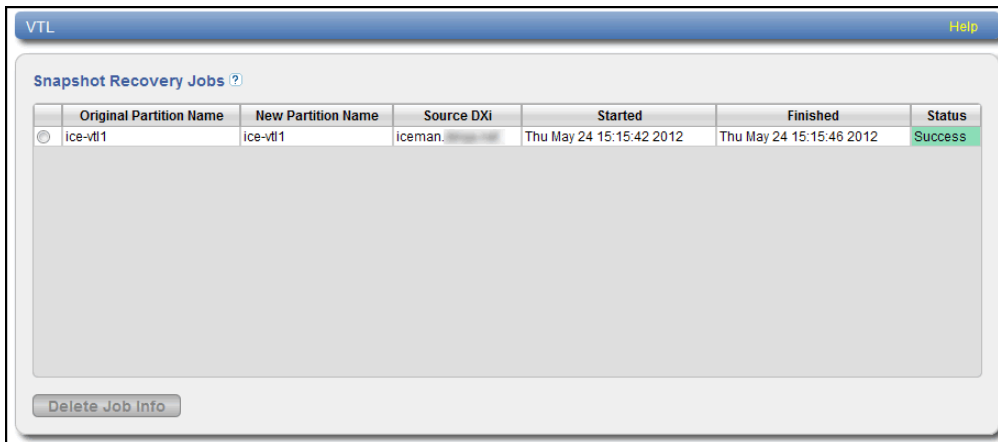

The **Snapshot Recovery Jobs** section displays the following information about recovery jobs:

<b>Original Partition Name</b>	The name of the partition the snapshot was created from.
<b>New Partition Name</b>	The name of the partition the snapshot was recovered to.
<b>Source DXi</b>	The hostname of the system that the snapshot was received from.
<b>Started</b>	The time the recovery job was started.
<b>Finished</b>	The time the recovery job finished.
<b>Status</b>	The status of the recovery job ( <b>Success</b> , <b>In Progress</b> , or <b>Failed</b> ).

To delete information for a recovery job, select it in the **Snapshot Recovery Jobs** list and click **Delete Job Info**.

## Failback Jobs

The **Failback Jobs** page allows you to view information about snapshot failback operations that were previously completed. You can also abort a failback that is currently in progress.

To access the **Failback Jobs** page, on the **Receive VTL** page, click the **Failback Jobs** tab (see [Figure 102 on the next page](#)).

Figure 102: Failback Jobs Page

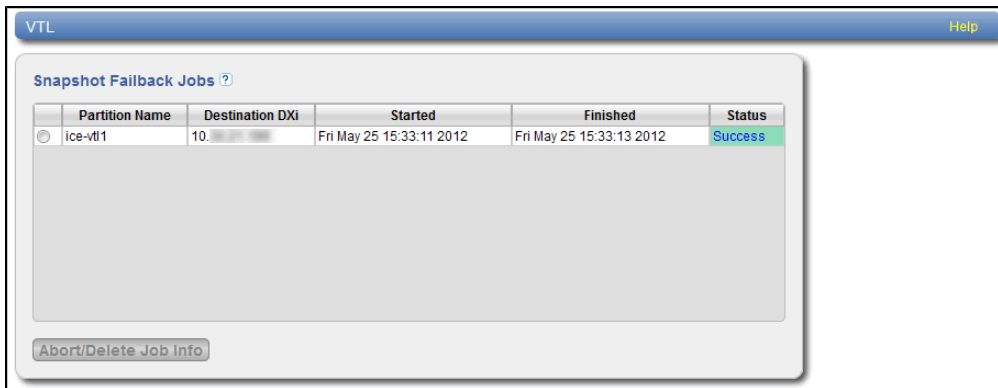

The **Snapshot Failback Jobs** section displays the following information about failback jobs:

<b>Partition Name</b>	The name of the partition the snapshot was created from.
<b>Destination DXi</b>	The hostname of the system that the snapshot was sent to.
<b>Started</b>	The time the failback job was started.
<b>Finished</b>	The time the failback job finished.
<b>Status</b>	The status of the failback job ( <b>Success</b> , <b>In Progress</b> , or <b>Failed</b> ).

Use the **Failback Jobs** page to perform the following tasks:

- To delete information for a failback job, select it in the **Snapshot Failback Jobs** section and click **Delete Job Info**.
- To abort a failback job that is in progress, select it in the **Snapshot Failback Jobs** section and click **Abort**.

## Cartridge Based

The **Cartridge Based** page allows you to manage Cartridge Based Replication on the target system. You can configure a VTL partition to receive Cartridge Based Replication data sent from a source system and view replication statistics for the partition.

**i Note:** For information about creating VTL partitions, see [Adding a VTL Partition on page 233](#).

To access the **Cartridge Based** page, on the **Receive VTL** page, click the **Cartridge Based** tab (see [Figure 103 on the next page](#)).

Figure 103: Cartridge Based Page

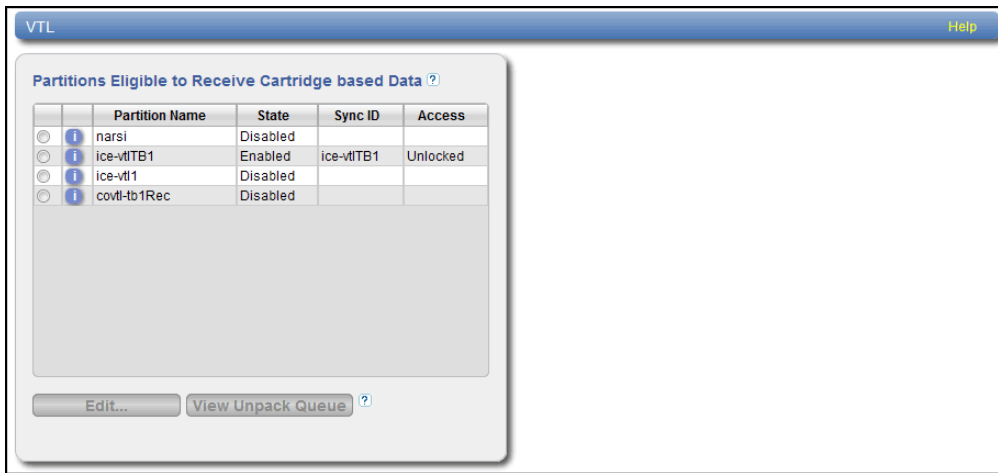

### Tasks

Use the **Cartridge Based** page to perform the following tasks:

- View partitions eligible to receive Cartridge Based data (see [Partitions Eligible to Receive Cartridge Based Data below](#))
- Configure a partition to receive Cartridge Based Replication data (see [Configuring a Target Partition for Cartridge Based Replication on the next page](#))
- View statistics for partitions configured for Cartridge Based Replication (see [Unpack Queue on page 173](#))

### Partitions Eligible to Receive Cartridge Based Data

The **Partitions Eligible to Receive Cartridge Based Data** section displays information for all VTL partitions on the DXi6900 that are eligible to receive Cartridge Based Replication data from a source partition. To be eligible to receive Cartridge Based Replication data, a partition must have data deduplication enabled at the time it is created.

The **Partitions Eligible for Replication** section displays the following information:

<b>Partition Name</b>	The name of the partition.
<b>State</b>	The state of Cartridge Based Replication for the partition ( <b>Enabled</b> or <b>Disabled</b> ).
<b>Sync ID</b>	The Sync ID used to identify the source partition that will send replicated data to the partition.
<b>Access</b>	The selected access option for the partition ( <b>Locked</b> or <b>Unlocked</b> ).

**i Note:** Click the Information button **[i]** next to a partition to display detailed information about the partition and recent replication activity.

### Configuring a Target Partition for Cartridge Based Replication

Configuring a VTL partition for Cartridge Based Replication enables the automatic replication of cartridges on the source partition to the target partition. Before you configure a partition on the source system for Cartridge Based Replication, you must configure a partition on the target system to receive the replicated data from the source partition.

**i Note:** For information about configuring Cartridge Based Replication on the source system, see [Configuring Directory/File or Cartridge Based Replication on page 149](#).

To configure a target partition for Cartridge Based Replication:

1. Select the partition and click **Edit**.

The **Edit Partition Settings** page displays (see [Figure 104 below](#)).

**Figure 104:** Edit Partition Settings Page



2. Select the **Enable to receive Cartridge Based replication data** check box to enable Cartridge Based Replication for the partition.

Or clear the **Enable to receive Cartridge Based replication data** check box to disable Cartridge Based Replication for the partition.

3. Enter a **Sync ID** in the box.

The Sync ID is used to identify the source partition that will send replicated data to the target partition. The Sync ID *must* be identical to the Sync ID of the source partition on the source system.

4. Select an **Access** option:

- **Locked** - The partition is not allowed to receive new Cartridge Based Replication data.
- **Unlocked** - The partition is allowed to receive new Cartridge Based Replication data.

If a partition configured for Cartridge Based Replication is locked on the target system, synchronization jobs may fail on the source system.

5. Click **Apply**.

## Unpack Queue

Use the **Unpack Queue** to view Cartridge Based Replication statistics for data received from the source system.

To view the **Unpack Queue**, select a partition and click **View Unpack Queue** (see [Figure 105 below](#)).

**Figure 105:** Unpack Queue

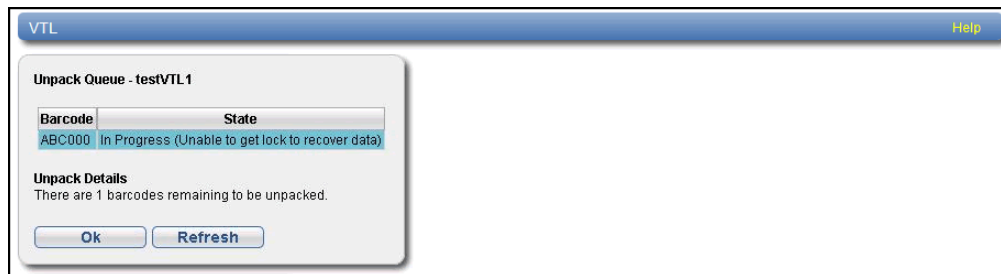

The **Unpack Queue** displays the following information:

<b>Barcode</b>	The barcode of the cartridge to be replicated.
<b>State</b>	The replication state of the cartridge.

Click **Refresh** to update the statistics in the Unpack Queue. Click **OK** to return to the **Cartridge Based** page.

---

## Actions

The **Actions** page allows you to manage replication activity on the DXi6900. You can pause the replication service, enable the replication state, and clear performance statistics.

To access the **Actions** page, click the **Replication** menu, and then click the **Actions** tab (see [Figure 106 on the next page](#)).

Figure 106: Actions Page

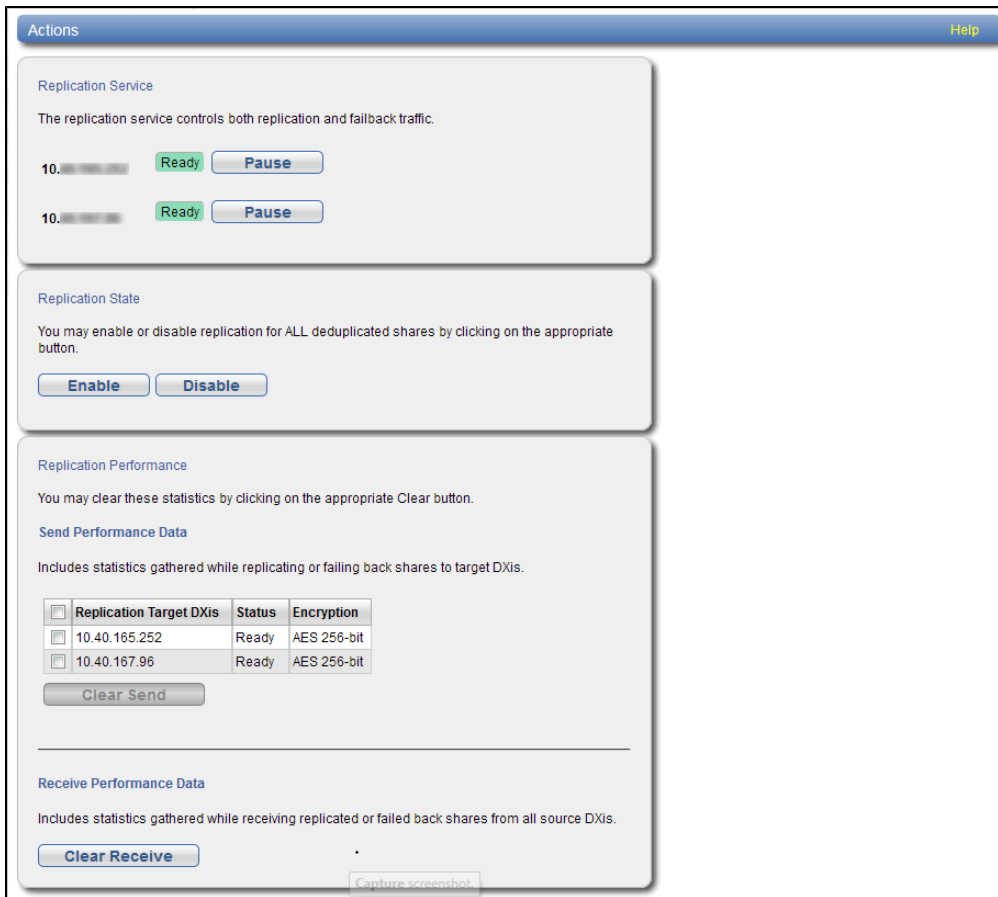

## Tasks

Use the **Actions** page to perform the following tasks:

- Pause or resume the replication service (see [Replication Service below](#)).
- Enable or disable the replication state (see [Replication State on the next page](#)).
- Clear cumulative replication statistics (see [Replication Performance on the next page](#)).

## Replication Service

The replication service controls replication and failback traffic on the DXi6900. You can pause each replication target independently.

- Click **Pause** next to a target to pause all replication and failback traffic to that target.

If a replication job is currently in progress, the system continues to replicate the current block of data. The process of replicating the current block can take up to 15 minutes to complete. After the block has completed replication, the system pauses replication.

---

**i Note:** If you pause a replication job that is in process, a Failure event is logged in the replication report (see [Reports on the next page](#)).

- Click **Resume** next to a target to resume all incoming and outgoing replication and failback traffic to that target.

If a replication job was in progress when replication was paused, the replication job continues.

## Replication State

The replication state applies to all NAS shares or VTL partitions on the DXi6900 that are eligible for replication (that is, all deduplicated shares or partitions).

---

**i Note:** The **Replication Actions** page may appear busy for a few moments when enabling or disabling the replication state. Wait for the process to complete before performing other actions.

- Click **Enable** to enable replication for all shares or partitions.
- Click **Disable** to disable replication for all shares or partitions.

If a replication job is currently in progress, the system continues until the entire replication job is complete. After the replication job has completed, the system disables replication. The system will not be able to replicate data for any shares or partitions until you click **Enable**.

---

**i Note:** To disable replication for a single share or partition, select it on the **Replication > Send** page and click **Edit**. Clear the **Enable replication** and the **Enable scheduled replication** check boxes, and then click **Apply**. For more information, see [Replication Send on page 145](#).

## Replication Performance

The DXi6900 maintains cumulative performance statistics for send and receive replication activity. The statistics appear on the **Home** page and elsewhere. You can reset these statistics so the system will calculate them with new data going forward.

### Clear Send Statistics

To clear send statistics, first select one or more targets to clear statistics for, and then click **Clear Send**. This resets cumulative performance statistics gathered while replicating shares or partitions to the selected target systems, or when sending a snapshot during a failback operation.

### Clear Receive Statistics

To clear receive statistics, click **Clear Receive**. This resets cumulative performance statistics gathered while receiving replicated shares or partitions from source systems, or when receiving a snapshot during a failback operation.

# Reports

The **Reports** page allows you to generate and download a replication report. The report includes detailed information about all replication activity, including Directory/File or Cartridge Based Replication.

To access the **Reports** page, click the **Replication** menu, and then click the **Reports** tab (see [Figure 107 below](#)).

**Figure 107:** Reports Page

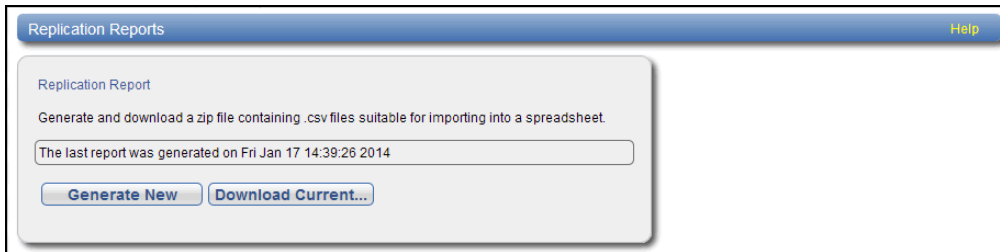

Use the **Reports** page to perform the following tasks:

To generate a new replication report, click **Generate New**.

- To download the most recently generated replication report, click **Download Current**.
- Save the replication report to your local workstation, and then unzip the downloaded file. The report consists of a ZIP file that contains multiple CSV (comma separated value) files. To view the CSV files, open them in a compatible spreadsheet application.





# Chapter 7: Status

---

This chapter contains the following topics:

Status .....	177
Hardware .....	178
Performance .....	185
Disk Usage .....	190
VTL Status .....	193
Accent Status (DXi6900-S) .....	197
OST Status .....	199
Activity Log .....	201

---

## Status

The **Status** page allows you to view status information for the DXi6900 hardware as well as performance and disk usage information.

**i Note:** Status information is gathered by the system every two minutes.

To access the **Status** pages, click the **Status** menu.

The **Status** pages contains the following tabs:

- [Hardware below](#)
- [Performance on page 185](#)
- [Disk Usage on page 190](#)
- [VTL Status on page 193](#)
- [Accent Status \(DXi6900-S\) on page 197](#)
- [OST Status on page 199](#)
- [Activity Log on page 201](#)

---

## Hardware

The **Hardware** page allows you to view information about the hardware components of the DXi6900. You can view the overall status of the node as well as detailed status information for components such as the system board, host bus adapters, network ports, and storage arrays.

To access the **Hardware** page, click the **Status** menu, and then click the **Hardware** tab.

The **Hardware** page contains the following tabs:

### Summary

The **Hardware Summary** page allows you to view the overall status of the node and its main components. The system and each component can have one of the following statuses:

<b>Normal</b>	(Green) The hardware is operating correctly.
<b>Attention</b>	(Yellow) There is a problem with the hardware.
<b>Failed</b>	(Red) The hardware has failed.

To access the **Hardware Summary** page, on the **Hardware** page, click the **Summary** tab (see [Figure 108 on the next page](#)).

**Figure 108:** Hardware Summary Page

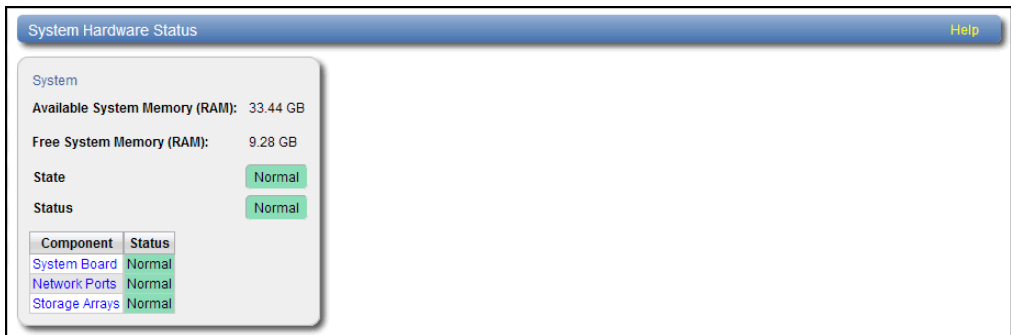

The **Hardware Summary** page displays the following information:

<b>Available System Memory (RAM)</b>	The total amount of memory (RAM) installed in the system.
<b>Free System Memory (RAM)</b>	The amount of system memory (RAM) that is currently free.
<b>State</b>	The status of the node.
<b>Status</b>	The overall status of all components in the node.
<b>Component Name</b>	The name of the main component. Click the component name to see detailed information (see <a href="#">Details below</a> ).
<b>Component Status</b>	The overall status of the main component.

## Details

The **Details** page allows you to view detailed information about the hardware components of the DXi6900.

To access the **Details** page, on the **Hardware** page, click the **Details** tab.

Use the **Details** page to view information for the following components:

### System Board

The **System Board** page allows you to view information reported by the main system board in the node, such as temperature, voltage, fan, and power supply information.

To access the **System Board** page, on the **Details** page, click the **System Board** tab (see [Figure 109 on the next page](#)).

Figure 109: System Board Page

Component	Type	Value	Status
IPMI	IPMI	NA	Normal
Inlet Temperature	Temperature	25 degrees C	Normal
Exhaust Temperature	Temperature	48 degrees C	Normal
CPU1 Temperature	Temperature	52 degrees C	Normal
CPU2 Temperature	Temperature	55 degrees C	Normal
CMOS Battery	Alarm	NA	Normal
ROMB Battery	Alarm	NA	Normal
CPU1 VCORE PG	Alarm	NA	Normal
CPU2 VCORE PG	Alarm	NA	Normal
3.3V PG	Alarm	NA	Normal
5V PG	Alarm	NA	Normal
CPU1 PLL PG	Alarm	NA	Normal
CPU2 PLL PG	Alarm	NA	Normal
1.1V PG	Alarm	NA	Normal
CPU1 M23 VDDQ PG	Alarm	NA	Normal
CPU1 M23 VTT PG	Alarm	NA	Normal
FETDRV PG	Alarm	NA	Normal
CPU1 VSA PG	Alarm	NA	Normal
CPU2 VSA PG	Alarm	NA	Normal
CPU1 M01 VDDQ PG	Alarm	NA	Normal
CPU2 M01 VDDQ PG	Alarm	NA	Normal
CPU2 M23 VTT PG	Alarm	NA	Normal
CPU2 M01 VTT PG	Alarm	NA	Normal
NDC PG	Alarm	NA	Normal
CPU2 VTT PG	Alarm	NA	Normal
CPU1 VTT PG	Alarm	NA	Normal
CPU2 M23 VDDQ PG	Alarm	NA	Normal
CPU1 Status	Alarm	NA	Normal
CPU2 Status	Alarm	NA	Normal
1.5V PG	Alarm	NA	Normal
BP1 5V PG	Alarm	NA	Normal
CPU1 M01 VTT PG	Alarm	NA	Normal
Power Consumption	Voltage	224 Watts	Normal
Fan Redundancy	Fan	Fully Redundant	Normal
Fan 1 RPM	Fan	5040 RPM	Normal
Fan 2 RPM	Fan	4920 RPM	Normal
Fan 3 RPM	Fan	5040 RPM	Normal
Fan 4 RPM	Fan	4920 RPM	Normal
Fan 5 RPM	Fan	5400 RPM	Normal
Fan 6 RPM	Fan	5160 RPM	Normal
PS 1 Status	Power Supply	NA	Normal
PS 1 AC	Power Supply	NA	Normal
PS 2 Status	Power Supply	NA	Normal
PS 2 AC	Power Supply	NA	Normal

The **System Board** page displays the following information:

<b>Component</b>	The name of the component on the system board.
<b>Type</b>	The component type (Sensor, Fan, or Power Supply).
<b>Value</b>	The value reported by the sensor or component.

---

<b>Status</b>	The status of the component. <b>Normal</b> - (Green) The component is operating correctly. <b>Attention</b> - (Yellow) There is a problem with the component. <b>Failed</b> - (Red) The component has failed.
---------------	--

---

## Host Bus Adapters

The **Host Bus Adapters** page allows you to view information about installed Fibre Channel or SAS cards and their ports.

To access the **Host Bus Adapters** page, on the **Details** page, click the **Host Bus Adapters** tab (see [Figure 110 below](#)).

**Figure 110:** Host Bus Adapters Page

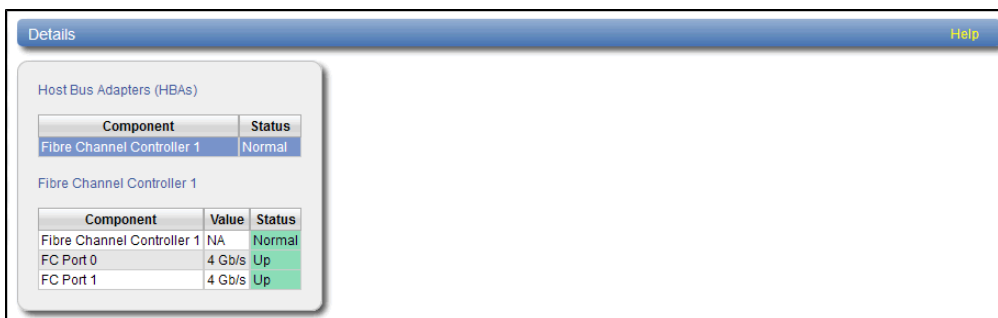

The **Host Bus Adapters** section displays the following information about each Fibre Channel or SAS card:

---

<b>Component</b>	The name of the Fibre Channel and/or SAS card. Click the name of the card to view detailed information for the card below.
------------------	---

---

<b>Status</b>	The status of the Fibre Channel or SAS card. <ul style="list-style-type: none"><li>• <b>Normal</b> - (Green) The component is operating correctly.</li><li>• <b>Attention</b> - (Yellow) There is a problem with the component.</li><li>• <b>Failed</b> - (Red) The component has failed.</li></ul>
---------------	---

---

The **Fibre Channel Controller** or **SAS HBA** section displays the following information about the ports in the selected Fibre Channel or SAS controller:

---

<b>Component</b>	The number of the Fibre Channel or SAS port.
------------------	--

---

---

<b>Value -</b>	The throughput capacity of the port (if connected).
----------------	---

---

<b>Status</b>	The status of the port. <ul style="list-style-type: none"><li>• <b>Up</b> - (Green) The port is connected.</li><li>• <b>Down</b> - (Green) The port is not connected.</li></ul>
---------------	---

---

## Network Ports

The **Network Ports** page allows you to view information about Ethernet ports in the system. The DXi6900 includes three or more Ethernet ports (depending on the configuration).

To access the **Network Ports** page, on the **Details** page, click the **Network Ports** tab (see [Figure 111 below](#)).

**Figure 111:** Network Ports Page

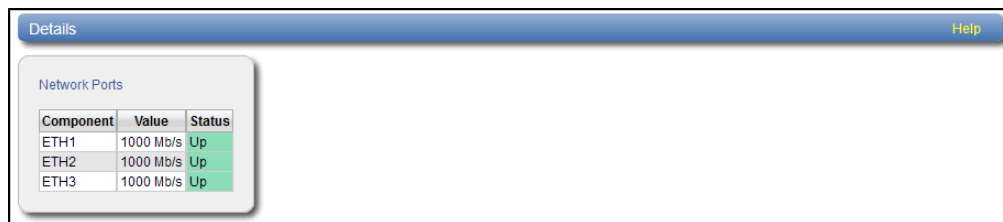

The **Network Ports** page displays the following information:

---

<b>Component</b>	The number of Ethernet port.
------------------	------------------------------

---

<b>Value</b>	The speed of the port in Mb/s
--------------	-------------------------------

---

<b>Status</b>	The status of the Ethernet port. <ul style="list-style-type: none"><li>• <b>Up</b> - (Green) The port is connected.</li><li>• <b>Down</b> - (Green) The port is not connected.</li></ul>
---------------	--

---

## Storage Arrays

The **Storage Arrays** page allows you to view information about storage arrays and controllers in the DXi6900.

To access the **Storage Arrays** page, on the **Details** page, click the **Storage Arrays** tab (see [Figure 112 on the next page](#)).

**Figure 112:** Storage Arrays Page

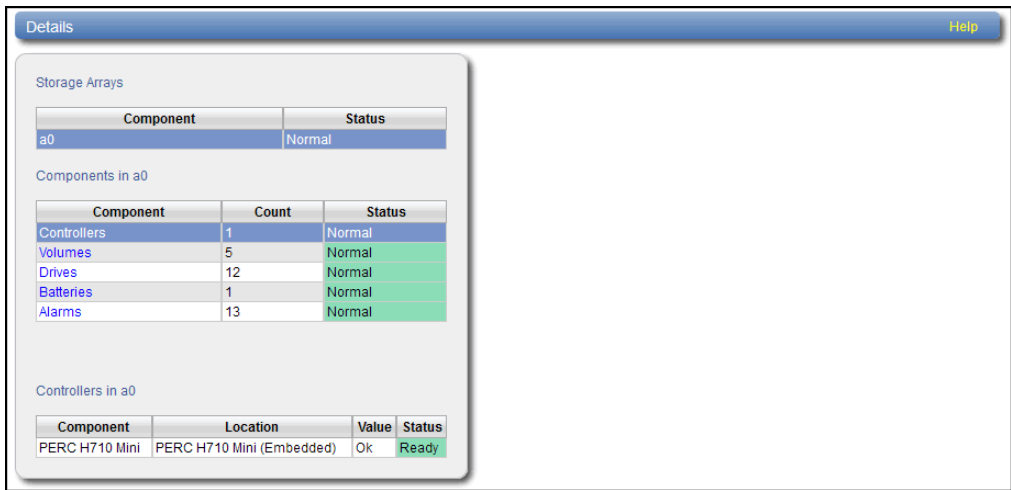

The **Storage Arrays** section displays the following information about each storage array:

<b>Component</b>	The name of the storage array.  Click the name of the storage array to view detailed information for the array in the <b>Component</b> section.
<b>Status</b>	The status of the storage array. <ul style="list-style-type: none"> <li>• <b>Normal</b> - (Green) The component is operating correctly.</li> <li>• <b>Attention</b> - (Yellow) There is a problem with the component.</li> <li>• <b>Failed</b> - (Red) The component has failed.</li> </ul>

The **Components** section displays the following information about the components in the selected storage array:

<b>Component</b>	The name of the component.  Click the name of the component to view detailed information for the component in the subcomponent section.
<b>Count</b>	The number of that component type in the system.

---

<b>Status</b>	The status of the component: <ul style="list-style-type: none"><li>• <b>Normal</b> - (Green) The component is operating correctly.</li><li>• <b>Attention</b> - (Yellow) There is a problem with the component.</li><li>• <b>Failed</b> - (Red) The component has failed.</li></ul>
---------------	---

---

The subcomponent section displays the following information about the subcomponents in the selected component:

---

<b>Component</b>	The name of the subcomponent.
<b>Location</b>	The location of the subcomponent within the system.
<b>Value</b>	The value reported by the subcomponent.
<b>Status</b>	The status of the subcomponent. <ul style="list-style-type: none"><li>• <b>Normal</b> - (Green) The component is operating correctly.</li><li>• <b>Attention</b> - (Yellow) There is a problem with the component.</li><li>• <b>Failed</b> - (Red) The component has failed.</li></ul>

---

## Firmware Version

The **Firmware Version** page allows you to view information about hardware components installed in the DXi6900, such as the firmware version, hardware revision, and manufacturer.

To access the **Firmware Version** page, on the **Hardware** page, click the **Firmware Version** tab (see [Figure 113 on the next page](#)).



Figure 113: Firmware Version Page

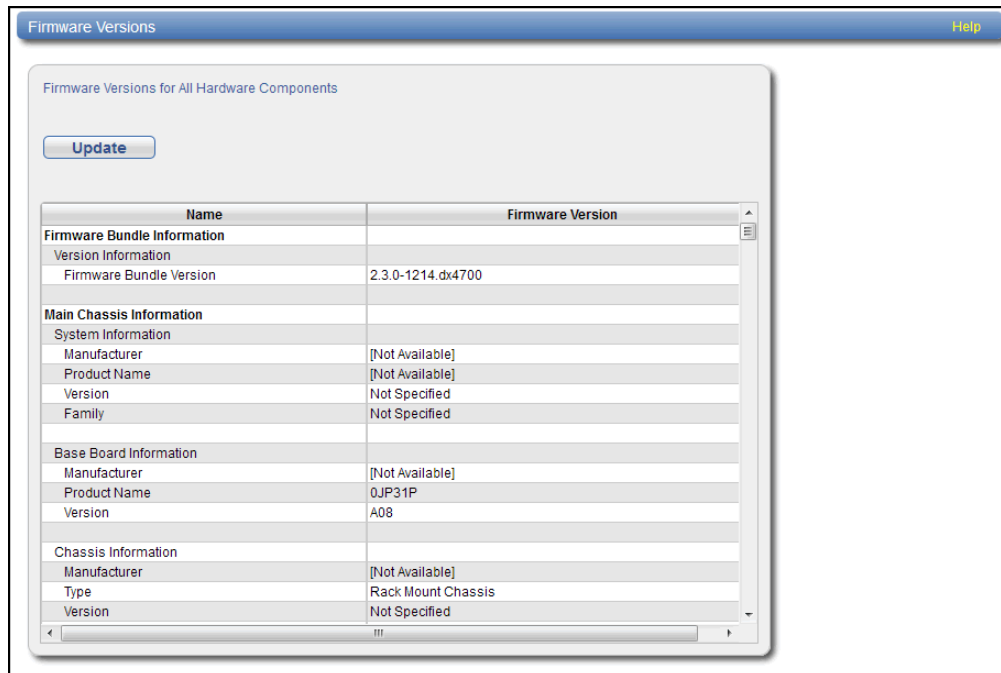

The **Firmware Version** page displays the following information:

**Name** Displays a hardware component or a property of the component (for example, **Manufacturer**, **Version**, or **Release Date**)

**Note:** The properties that are listed vary depending on the hardware component.

**Firmware Version** The value of the corresponding item in the **Name** column (for example, the specific manufacturer, version number, or release date for the item).

Click **Update** to refresh the table with the latest information.

**Note:** In some cases, when updating firmware versions, the remote management console may time out and then return to the **Home** page. If this occurs, simply navigate back to the **Status > Hardware > Firmware Version** page to see the updated information.

## Performance

The **Performance** page allows you to view information about system performance, including inline throughput, network throughput, read/write throughput, and CPU usage.

To access the **Performance** page, click the **Status** menu, and then click the **Performance** tab.

The **Performance** page contains the following tabs:

## Inline

The **Inline** page allows you to view throughput performance for inline data flow. Inline data flow includes deduplicated and non-deduplicated backup data as well as received replication data.

To access the **Inline** page, on the **Performance** page, click the **Inline** tab (see [Figure 114 below](#)).

**Figure 114:** Inline Page

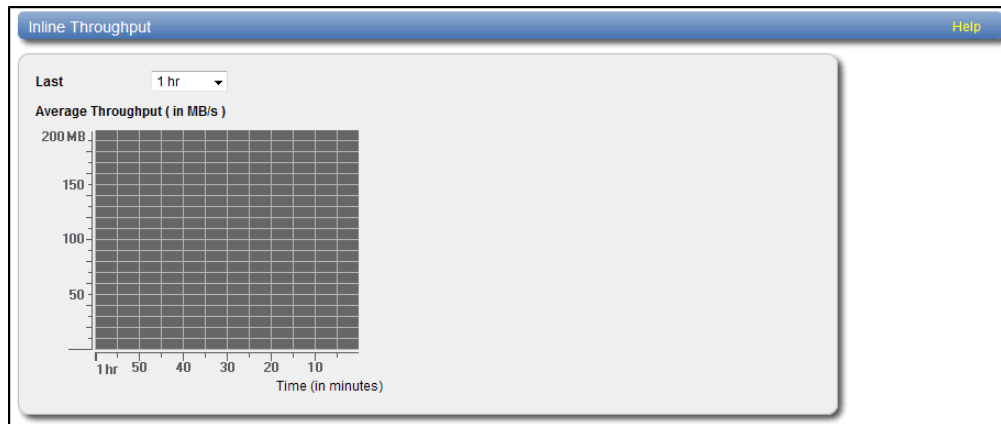

Use the **Inline** page to display recent inline data flow activity in a dynamic graph:

- Select the amount of time to display in the **Last** list (1–24 hours).
- The horizontal axis displays time (in minutes).
- The vertical axis displays inline throughput (0–2,000 MB/s).

**i Note:** The range represented by the Y-axis changes based on the maximum value, increasing in 200 MB increments as needed.

- Each bar on the graph represents approximately 1 minute of time.
- Hold the cursor over a bar to display the value of the bar.

## Ethernet

The **Ethernet** page allows you to view throughput performance for network send and receive activity.

To access the **Ethernet** page, on the **Performance** page, click the **Ethernet** tab (see [Figure 115 on the next page](#)).

**Figure 115:** Ethernet Page

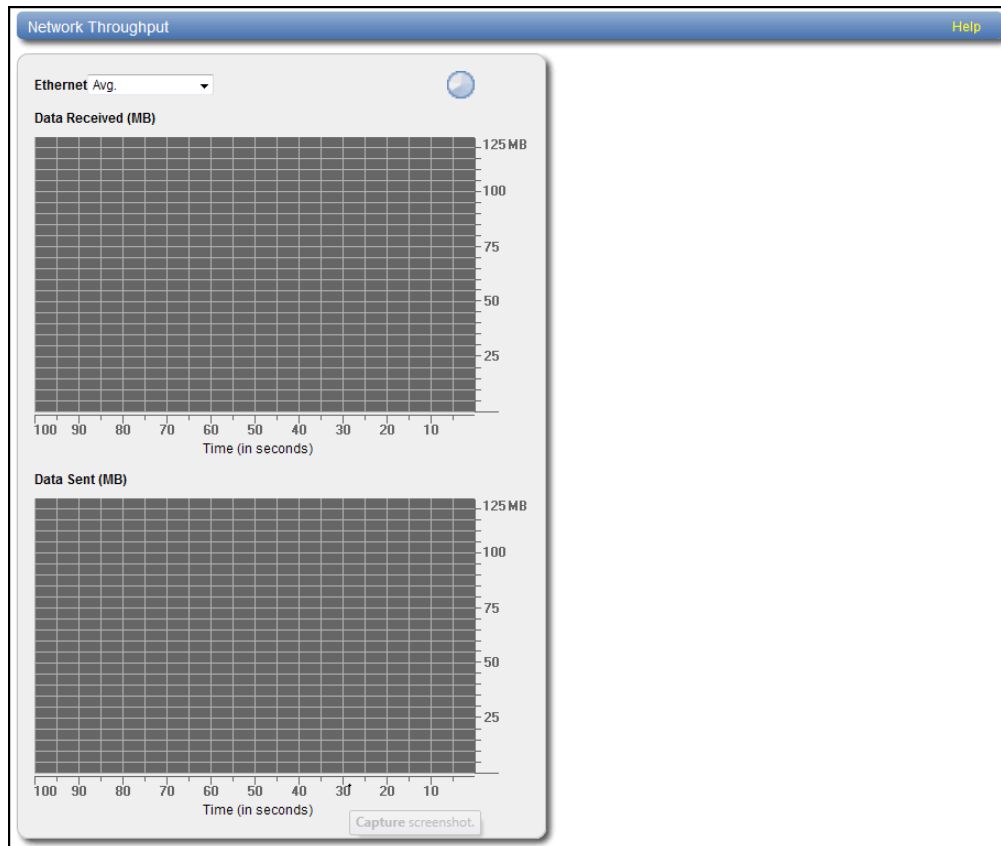

Use the **Ethernet** page to display recent network activity in dynamic graphs:

- The top graph reports data received and the bottom graph reports data sent.
- Select the port to monitor in the **Ethernet** drop-down box, or select **Avg** to display an average of all ports.
- The horizontal axis displays time (0–100 seconds).
- The vertical axis displays data throughput (0–125 MB/s for 1 GbE ports or 0–1.25 GB/s for 10 GbE ports).
- Values that exceed the maximum value of the vertical axis are shown in lighter green.
- Each bar on the graph represents approximately 1 second of time.
- Hold the cursor over a bar to display the value of the bar.

## RAID

The **RAID** page allows you to view throughput performance for RAID read and write activity.

To access the **RAID** page, on the **Performance** page, click the **RAID** tab (see [Figure 116 on the next page](#)).

**Figure 116:** RAID Page

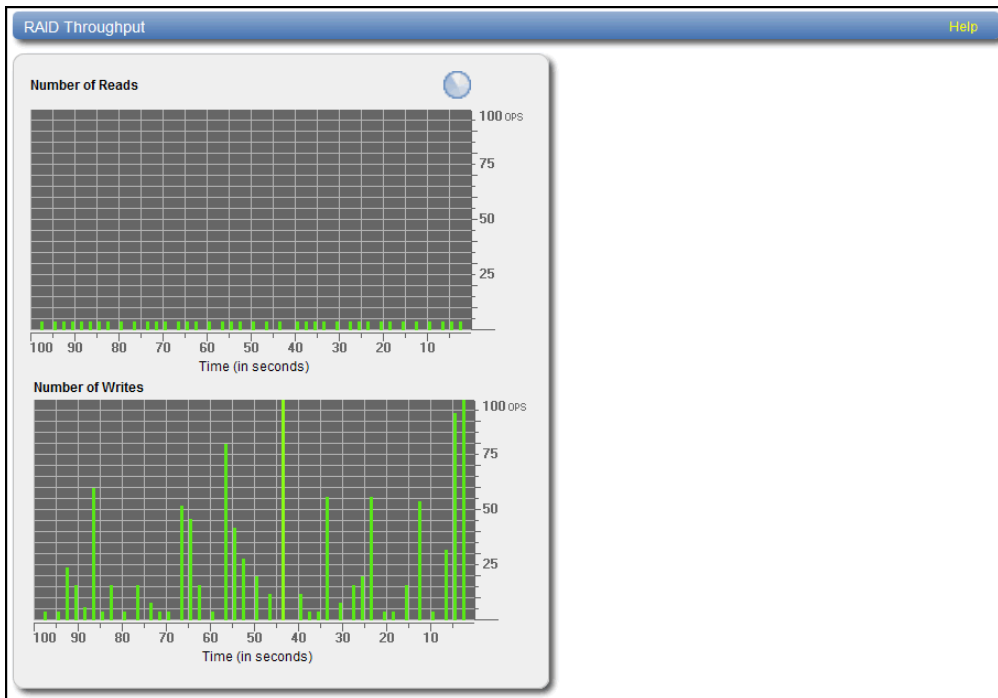

Use the **RAID** page to display recent RAID activity in dynamic graphs:

- The top graph reports data reads and the bottom graph reports data writes.
- The horizontal axis displays time (0–100 seconds).
- The vertical axis displays the amount of data read or written (100 OPS/s).
- Values that exceed the maximum value of the vertical axis are shown in lighter green.
- Each bar on the graph represents approximately 1 second of time.
- Hold the cursor over a bar to display the value of the bar.

## Fibre Channel

The **Fibre Channel** page allows you to view throughput performance for Fibre Channel send and receive activity.

To access the **Fibre Channel** page, on the **Performance** page, click the **Fibre Channel** tab (see [Figure 117 on the next page](#)).

**Figure 117:** Fibre Channel Page

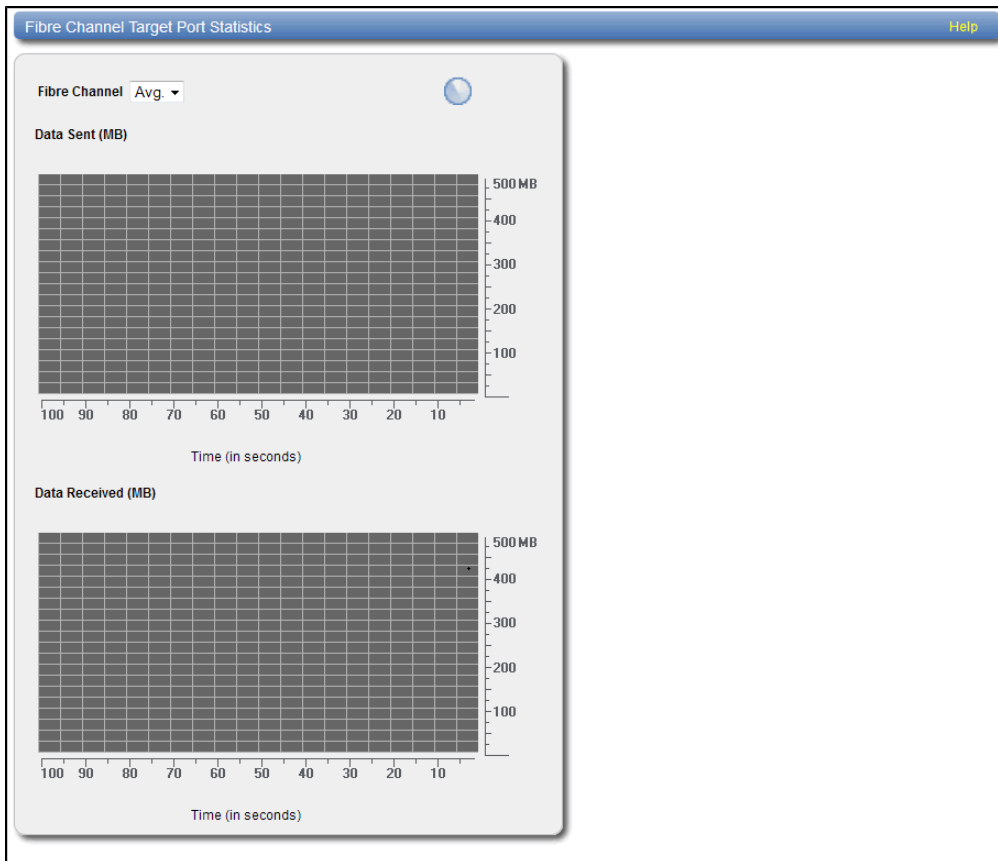

Use the **Fibre Channel** page to display recent fibre channel activity in dynamic graphs:

- The top graph reports data received and the bottom graph reports data sent.
- Select the port to monitor in the **Fibre Channel** drop-down box, or select **Avg** to display an average of all ports.
- The horizontal axis displays time (0–100 seconds).
- The vertical axis displays data throughput (0–500 MB/s).
- Values that exceed the maximum value of the vertical axis are shown in lighter green.
- Each bar on the graph represents approximately 1 second of time.
- Hold the cursor over a bar to display the value of the bar.

## CPU

The **CPU** page allows you to view CPU usage.

To access the CPU page, on the **Performance** page, click the **CPU** tab (see [Figure 118 on the next page](#)).

**Figure 118:** CPU Page

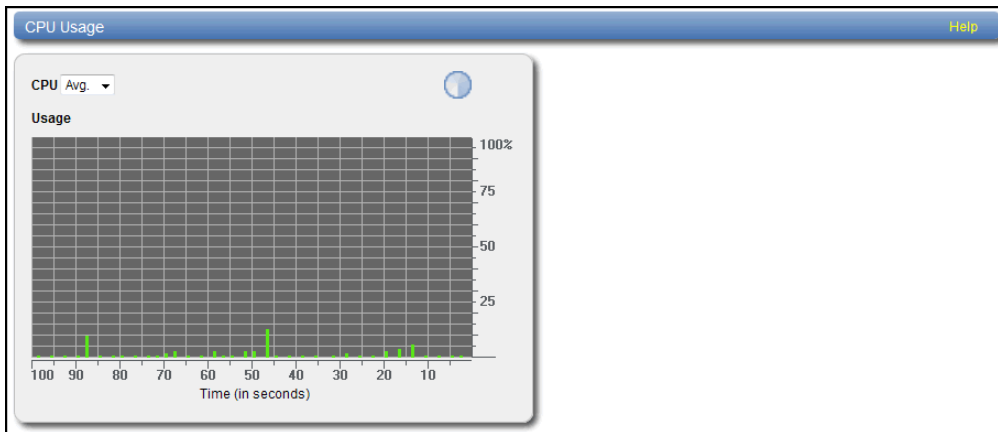

Use the **CPU** page to display recent CPU usage in a dynamic graph:

- Select the CPU core to monitor in the **CPU** drop-down box, or select **Avg** to display an average of all CPUs.
- The **CPU** drop-down box lists all CPU threads. Each hyper-threaded CPU core counts as two threads.
- The horizontal axis displays time (0–100 seconds).
- The vertical axis displays CPU usage (0–100%).

---

**i Note:** Each bar on the graph represents approximately 1 second of time.

- Hold the cursor over a bar to display the value of the bar.

---

## Disk Usage

The **Disk Usage** page allows you to view information about free and used disk space on the system. You can also view data reduction statistics.

To access the **Disk Usage** page, click the **Status** menu, and then click the **Disk Usage** tab (see [Figure 119 on the next page](#)).

**Figure 119:** Disk Usage Page

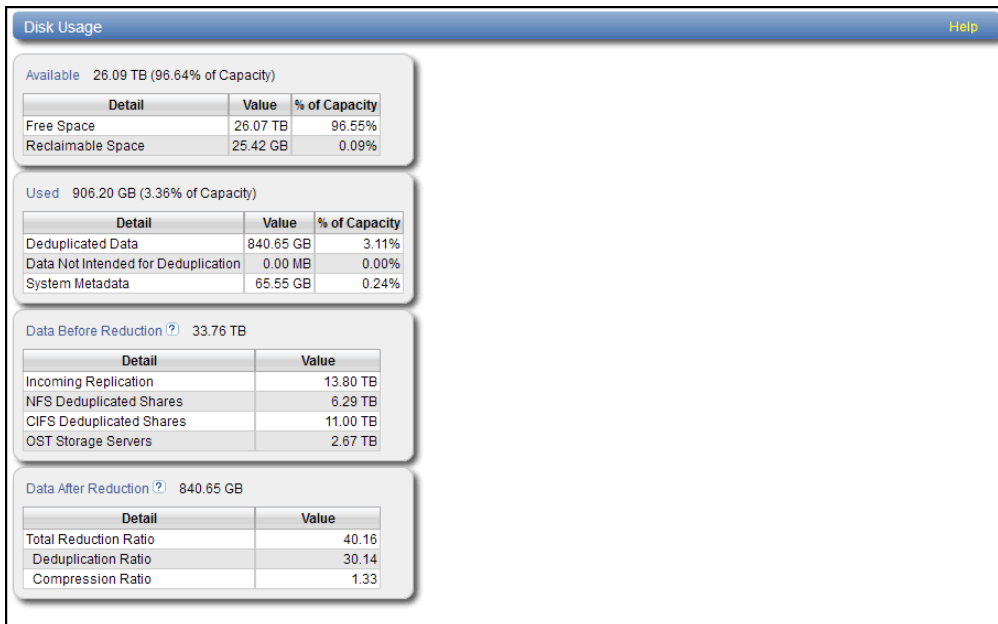

Use the **Disk Usage** page to view the following information:

## Available

Available space is the area that is available for data storage. The **Available** value is displayed as an amount and as a percentage of the total capacity in the system.

Available space is divided into the following categories:

Category	Description
<b>Free Space</b>	The disk space that can be used for new deduplicated or non-deduplicated data.
<b>Reclaimable Space</b>	The disk space that is occupied by outdated deduplicated data and which will be automatically reused if additional space for new deduplicated data is needed.

**i Note:** For optimal system performance, Quantum recommends keeping the amount of **Available** disk space at 20% or more.

## Used

Used space is the area that already holds data. The **Used** value is displayed as an amount and as a percentage of the total capacity in the system.

Used space is divided into the following categories:

Category	Description
<b>Deduplicated Data</b>	The amount of data that has been deduplicated.
<b>Data Not Intended For Deduplication</b>	The amount of data that will not be deduplicated (data on shares or partitions that do not have deduplication enabled).
<b>System Metadata</b>	The amount of disk space used for internal operations of the DXi, including system configuration files as well as temporary files created during replication, space reclamation, and healthchecks.

## Data Before Reduction

The **Data Before Reduction** value represents the original, native size of all data that has been processed by the data deduplication and compression engines.

Data before reduction is divided into the following categories:

Category	Description
<b>Incoming Replication</b>	The amount of data stored on the DXi via replication from another DXi. This does <i>not</i> include incoming data from Directory/File or Cartridge Based Replication, or incoming data from Failback replication.
<b>NFS Deduplicated Shares</b>	The amount of data stored in deduplicated shares configured in Network File System (NFS) format for Linux systems. This includes incoming data from Directory/File Based Replication, and incoming data from Failback replication.
<b>CIFS/SMB Deduplicated Shares</b>	The amount of data stored in deduplicated shares configured in Common Internet File System (CIFS/SMB), also known as Server Message Block (SMB), format for Windows systems. This includes incoming data from Directory/File Based Replication, and incoming data from Failback replication.
<b>Deduplicated Partitions</b>	The amount of data stored in deduplicated partitions. This includes incoming data from Cartridge Based Replication, and incoming data from Failback replication.
<b>OST Storage Servers</b>	The amount of data stored in deduplicated OpenStorage (OST) storage servers. This includes incoming data for OST and DXi Accent.

## Data After Reduction

The **Data After Reduction** value represents the final, reduced size of all data that has been processed by the data deduplication and compression engines.



Data after reduction is divided into the following categories:

Category	Description
<b>Total Reduction Ratio</b>	The total reduction ratio of all data that has been processed by the data deduplication and compression engines ( <b>Data Before Reduction</b> divided by <b>Data After Reduction</b> ).
<b>Deduplication Ratio</b>	The deduplication ratio of all data that has been processed by the data deduplication engine.
<b>Compression Ratio</b>	The compression ratio of all data that has been processed by the compression engine.

---

## VTL Status

The **VTL Status** page allows you to view information about virtual tape library (VTL) components, including tape drives, storage slots, and cartridges. You can view a physical or logical representation of VTL components, or view VTL performance statistics.

**i Note:** For information about creating VTLs, see [Adding a VTL Partition on page 233](#).

To access the **VTL Status** page, click the **Status** menu, and then click the **VTL** tab.

The **VTL Status** page contains the following tabs:

### Physical View

The **Physical View** page allows you to view a physical representation of the virtual components in a VTL. You can view information about virtual tapes drives, storage slots, and cartridges.

To access the **Physical View** page, on the **VTL Status** page, click the **Physical View** tab (see [Figure 120 on the next page](#)).

Figure 120: Physical View Page

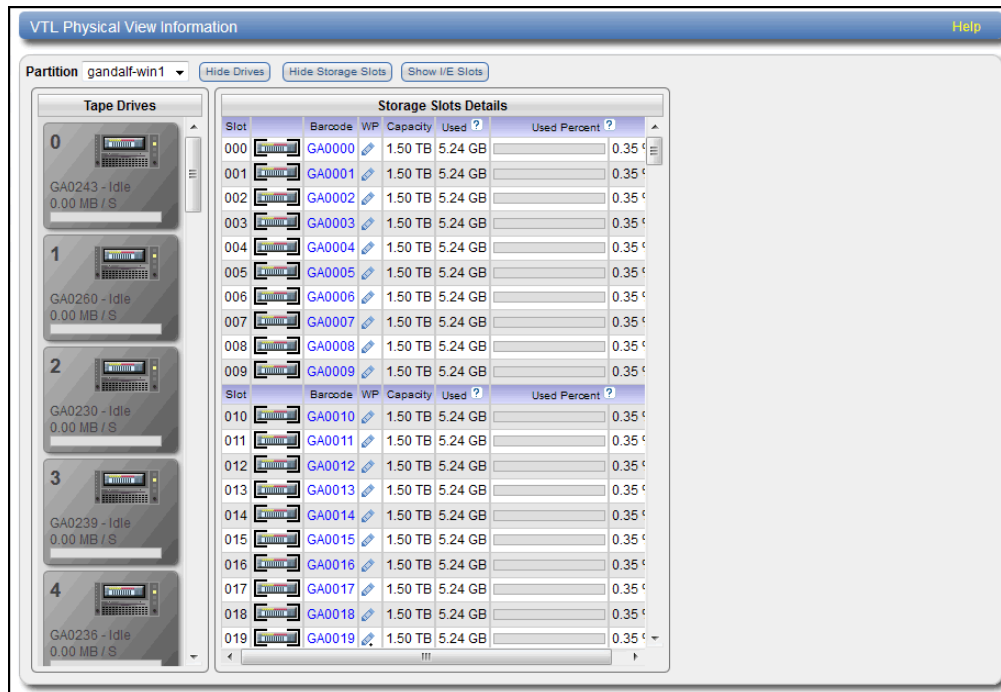

Use the controls in the **VTL Physical View Information** section to select the information to display:

1. Select the VTL to display in the **Partition** drop-down box.
2. Click **Hide Drives** or **Show Drives** to hide or show the virtual tape drives in the VTL (see [Tape Drives below](#)).
3. Click **Hide Storage Slots** or **Show Storage Slots** to hide or show the virtual storage slots in the VTL (see [Storage and I/E Slots below](#)).
4. Click **Hide I/E Slots** or **Show I/E Slots** to hide or show the virtual I/E slots in the VTL (see [Storage and I/E Slots below](#)).

### Tape Drives

The **Tape Drives** section displays information about virtual tape drives in the VTL:

- If a cartridge is mounted in the tape drive, the barcode of the cartridge displays beneath the drive.
- Click a tape drive to view detailed information about the drive.

### Storage and I/E Slots

The **Storage Slots** and **I/E Slots** sections displays information about the virtual cartridges located in the storage and I/E slots:

The following information is displayed for each cartridge:

<b>Slot</b>	The slot where the cartridge is located.
<b>Barcode</b>	The barcode of the cartridge.
<b>WP</b>	The write protect status of the cartridge.
<b>Capacity</b>	The capacity of the cartridge.
<b>Used</b>	The amount of space on the cartridge currently used to store data. The value for <b>Used</b> might be less than the original, native (raw) data size because the data is compressed before it is written to the media.
<b>Used Percent</b>	The amount of currently used space on the cartridge expressed as a percentage of the total capacity ( [ Used / Capacity ] x 100 ).

- Click a cartridge to view detailed information about the cartridge.
- When the storage system is degraded, all tape cartridges are shown in a degraded state.
- When the storage system has failed or is inaccessible due to failure, all tape cartridges are shown as unavailable.

## Logical View

Use the **Logical View** page to view information about the virtual (logical) components in a VTL partition. You can also view information about used space in the partition.

To access the **Logical View** page, on the **VTL Status** page, click the **Logical View** tab (see [Figure 121 below](#)).

**Figure 121:** Logical View Page

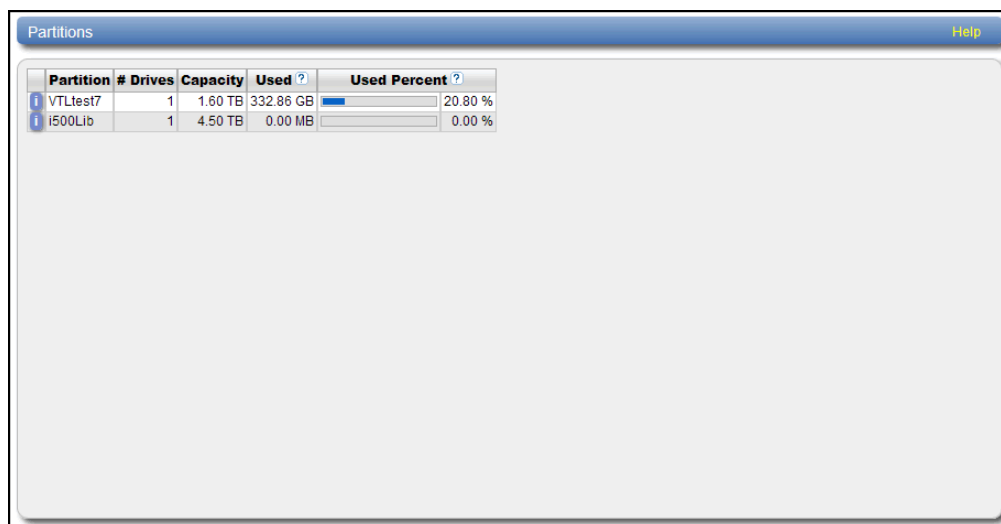

Partition	# Drives	Capacity	Used	Used Percent
i VTLtest7	1	1.60 TB	332.86 GB	20.80 %
i i500Lib	1	4.50 TB	0.00 MB	0.00 %

The **Partitions** section displays the following information about VTL partitions:

<b>Partition</b>	The name of the partition.
<b>Number of Drives</b>	The number of virtual tape drives in the partition.
<b>Capacity</b>	The storage capacity of the partition.
<b>Used</b>	The amount of space on all cartridges in the partition currently used to store data. The value for <b>Used</b> might be less than the original, native (raw) data size because the data is compressed before it is written to the media.
<b>Used Percent</b>	The amount of currently used space on all cartridges in the partition expressed as a percentage of the total capacity ( [ Used / Capacity ] x 100 ).

**i Note:** Click the **Information** button **[i]** next to a partition to display detailed information about the partition.

## Performance View

Use the **Performance View** page to view information about the throughput of VTL partitions. You can also view performance for virtual tape drives.

To access the **Performance View** page, on the **VTL Status** page, click the **Performance View** tab (see [Figure 122 on the next page](#)).

**Figure 122:** Performance View Page



The **Partition Throughput** section displays the following information about VTL partitions:

<b>Partition</b>	The name of the partition.  Click the partition name to display the tape drives in the partition. Click a tape drive to see individual performance information for that drive.
<b>Performance (write)</b>	The average write speed to the partition in MB/s.

**i Note:** Click the **Information** button [i] next to a partition to display detailed information about the partition. Click a tape drive to view detailed information about the drive.

## Accent Status (DXi6900-S)

Use the **Accent Status** page to view statistics for DXi Accent and NAS Application Specific (Oracle RMAN) activity that occurred in the previous minute.

To access the **Accent Status** page, click the **Status** menu, and then click the **Accent** tab (see [Figure 123 on the next page](#)).

**Figure 123:** Accent Status Page

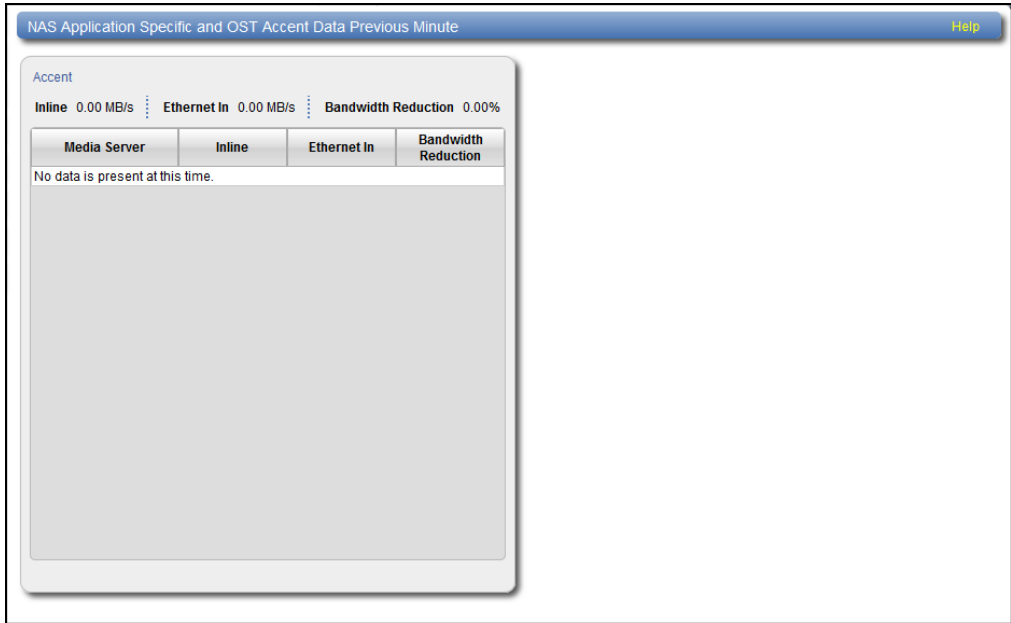

Combined statistics for all media servers display at the top of each section (**NAS Application Specific and Accent**).

<b>Inline</b>	The inline data flow throughput (in MB/s). Inline data flow represents the original, native size of the data protected by the DXi.
<b>Ethernet In</b>	The amount of data received by all Ethernet ports (in MB/s). This amount represents the reduced size of the data protected by the DXi (after deduplication and compression on the media servers).
<b>Bandwidth Reduction</b>	The percentage by which network bandwidth utilization was reduced by using RMAN or enabling Accent.

Statistics for individuals media servers display in the tables in each section (**NAS Application Specific and Accent**):

<b>Media Server</b>	The IP address of the media server.
<b>Inline</b>	The inline data flow throughput (in MB/s). Inline data flow represents the original, native size of the data protected by the DXi.
<b>Ethernet In</b>	The amount of data received by all Ethernet ports (in MB/s). This amount represents the reduced size of the data protected by the DXi (after deduplication and compression on the media server).
<b>Bandwidth Reduction</b>	The percentage by which network bandwidth utilization was reduced by using RMAN or enabling Accent.

# OST Status

(DXi6900) Use the **OST Status** page to view statistics for OST optimized duplication and DXi Accent activity that occurred in the previous minute.

**i Note:** DXi Accent statistics display only if DXi Accent is currently enabled or was previously enabled (see [DXi Accent on page 281](#)).

(DXi6900-S) Use the **OST Status** page to view statistics for OST optimized duplication and DXi activity that occurred in the previous minute.

To access the **OST Status** page, click the **Status** menu, and then click the **OST** tab (see [Figure 124 below](#) and [Figure 125 on the next page](#)).

**Figure 124:** DXi6900 OST Status Page

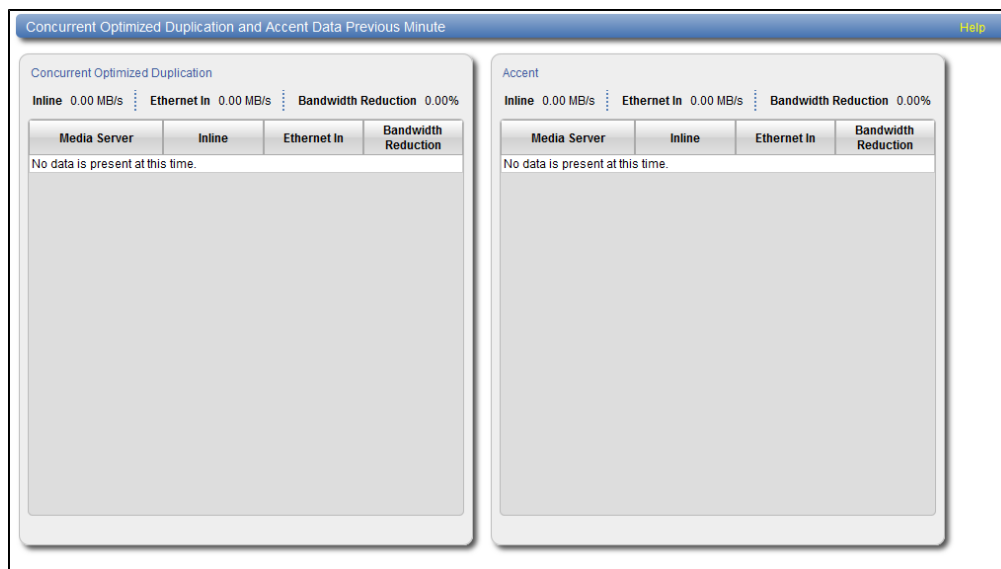
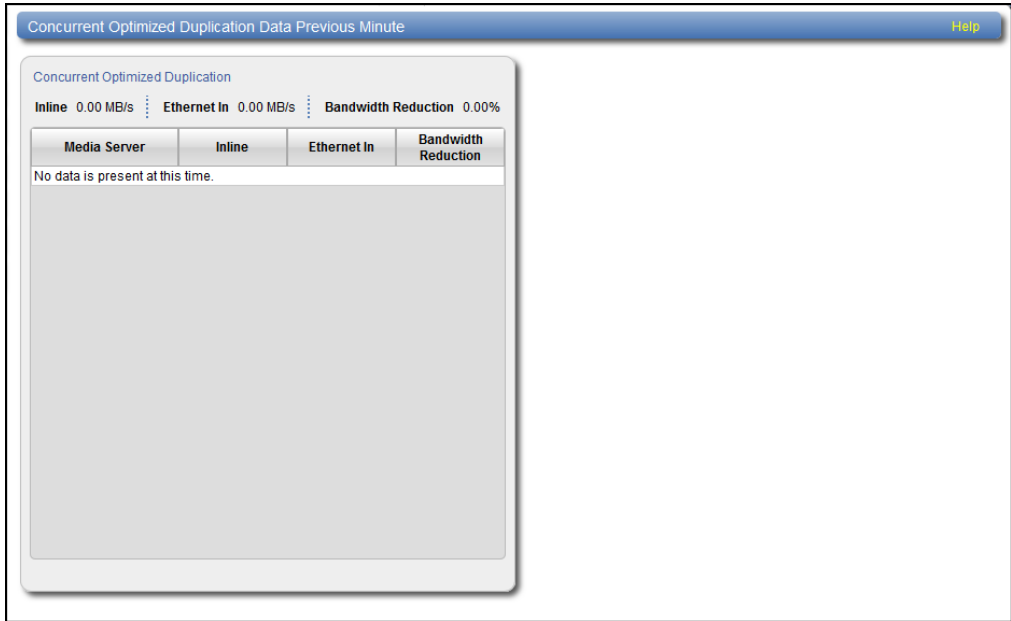

Figure 125: DXi6900-S OST Status Page



## DXi6900

Combined statistics for all media servers display at the top of each section (**Concurrent Optimized Duplication** and **Accent**).

<b>Inline</b>	The inline data flow throughput (in MB/s). Inline data flow represents the original, native size of the data protected by the DXi.
<b>Ethernet In</b>	The amount of data received by all Ethernet ports (in MB/s). This amount represents the reduced size of the data protected by the DXi (after deduplication and compression on the media servers).
<b>Bandwidth Reduction</b>	The percentage by which network bandwidth utilization was reduced by using optimized duplication or enabling Accent.

Statistics for individual media servers display in the tables in each section (**Optimized Duplication** and **Accent**):

<b>Media Server</b>	The IP address of the media server.
<b>Inline</b>	The inline data flow throughput (in MB/s). Inline data flow represents the original, native size of the data protected by the DXi.



---

<b>Ethernet In</b>	The amount of data received by all Ethernet ports (in MB/s). This amount represents the reduced size of the data protected by the DXi (after deduplication and compression on the media server).
<b>Bandwidth Reduction</b>	The percentage by which network bandwidth utilization was reduced by using optimized duplication or enabling Accent.

---

## DXi6900-S

Combined **Concurrent Optimized Duplication** statistics for all media servers display at the top of each section.

---

<b>Inline</b>	The inline data flow throughput (in MB/s). Inline data flow represents the original, native size of the data protected by the DXi.
<b>Ethernet In</b>	The amount of data received by all Ethernet ports (in MB/s). This amount represents the reduced size of the data protected by the DXi (after deduplication and compression on the media servers).
<b>Bandwidth Reduction</b>	The percentage by which network bandwidth utilization was reduced by using optimized duplication.

---

---

## Activity Log

The **Activity Log** page allows you to view a record of all activities performed by administrative and service users in the past 90 days. You can view the user who performed the activity, the time the activity was performed, and other information. You can also download the activity log to an XML file.

To access the **Activity Log** page, click the **Status** menu, and then click the **Logs** tab (see [Figure 126 on the next page](#)).

Figure 126: Activity Log Page

User	Date/Time	Origin	Action	Category	Role	Summary
Administrator	2014-01-24 11:39:50 AM M...	GUI	CREATE	UTILITY	ADMIN	ACTIONSTATUS=Success CLIENTID=10...--authenticate --name=admin--encrypted.password=*** --client=10...@GUI --apicallname=QSys_Authenticate
Administrator	2014-01-24 10:29:55 AM M...	GUI	CREATE	UTILITY	ADMIN	ACTIONSTATUS=Success CLIENTID=10...--authenticate --name=admin--encrypted.password=*** --client=10...@GUI --apicallname=QSys_Authenticate
Administrator	2014-01-24 9:52:14 AM MST	GUI	CREATE	UTILITY	ADMIN	ACTIONSTATUS=Success CLIENTID=10...--authenticate --name=admin--encrypted.password=*** --client=10...@GUI --apicallname=QSys_Authenticate
Administrator	2014-01-24 9:51:29 AM MST	GUI	UPDATE	UTILITY	ADMIN	ACTIONSTATUS=Success CLIENTID=10... --release=credential --credtoken=839266c786667820e91b261765c...
Administrator	2014-01-24 9:51:25 AM MST	GUI	CREATE	UTILITY	ADMIN	ACTIONSTATUS=Success CLIENTID=10...--authenticate --name=admin--encrypted.password=*** --client=10...@GUI --apicallname=QSys_Authenticate

### Tasks

Use the **Activity Log** page to perform the following tasks:

- View information about activities that have been recorded in the log (see [Viewing Logged Activities below](#)).
- Enable or disable the recording of activities in the log (see [Enabling or Disabling Activity Logging on the next page](#)).
- Delete one or more activities from the log (see [Deleting Logged Activities on page 204](#)).
- Download the activity log in XML format (see [Downloading the Activity Log on page 204](#)).

## Viewing Logged Activities

The **Administrative Activity Log** list displays the following information for each entry:

<b>User</b>	The user that performed the activity ( <b>GUI Administrator</b> , <b>GUI Monitor</b> , <b>GUI Service</b> , <b>ServiceLogin</b> , <b>CLI Admin</b> , or <b>CLI Viewer</b> ).
<b>Date/Time</b>	The date and time the activity was performed.
<b>Origin</b>	The interface where the activity originated. Possible origins are the <b>GUI</b> (remote management console) or the <b>CLI</b> (command line interface).
<b>Action</b>	The type of activity performed ( <b>Create</b> , <b>Update</b> , or <b>Delete</b> ).

<b>Category</b>	The category of the activity ( <b>Alert, Analyzer, Cluster, Date Time, Email, Event, Hard Drive Security, Healthcheck, NAS, Network, OST, PTT, Replication, Security, SNMP, Utility, or VTL</b> ).
<b>Role</b>	The role of the user that performed the activity ( <b>Admin</b> ).
<b>Summary</b>	Details about the activity that was performed, including CLI commands and field values.

### Additional Information

- Click a column heading to sort the rows in the table by that column. Click the column heading again to reverse the sort order.
- To rearrange the order of the columns, click and drag a column heading left or right. To show or hide columns, click the arrow to the right of a column heading. In the pop-up menu, point to **Columns**, then select the name of a column to show or hide it.

### Navigating in the Activity Log

Use the controls at the bottom of the **Administrative Activity Log** list to adjust the activity log view (see [Figure 127 below](#)):

- To view a specific page, type the page number in the box.
- To update the activity log with latest data, click the **Refresh** icon.

Figure 127: Activity Log View Controls

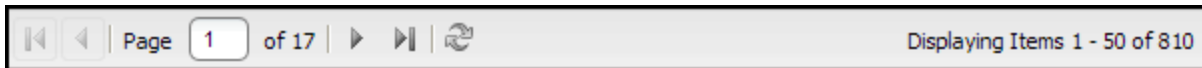

## Enabling or Disabling Activity Logging

By default, activity logging is enabled on the DXi6900. Use the toolbar above the **Administrative Activity Log** list to enable or disable activity logging (see [Figure 128 below](#)).

- To enable the logging of administrative and service actions, click **Enable Logging** on the toolbar.
- To disable the logging of administrative and service actions, click **Disable Logging** on the toolbar.
- To update the activity log with latest data, click **Refresh** on the toolbar.

Figure 128: Activity Log View Controls

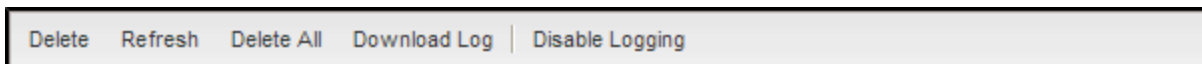

## Deleting Logged Activities

Use the toolbar above the **Administrative Activity Log** list to delete one or more entries in the activity log.

- To delete a log entry, select the entry and click **Delete**.
- To delete all entries in the activity log, click **Delete All**.

## Downloading the Activity Log

Use the toolbar above the **Administrative Activity Log** list to save the activity log in XML format. You can then open the log file in another program that is compatible with XML.

To download the activity log, click **Download Log**. Specify a location to save the file, and then click **OK** or **Save**.



# Chapter 8: Alerts

---

This chapter contains the following topics:

Alerts .....	205
Admin Alerts .....	206
Service Tickets .....	207

---

## Alerts

The **Alerts** page allows you to view and work with administration alerts and service tickets. The DXi6900 generates administration alerts and service tickets when a hardware or software event occurs.

To access the **Alerts** page, click the **Alerts** menu.

The **Alerts** page contains the following tabs:

- [Admin Alerts on the next page](#)
- [Service Tickets on page 207](#)



# Admin Alerts

The **Admin Alerts** page allows you to view and work with administration alerts. The DXi6900 generates an administration alert when the condition of the system has changed, such as going from the offline state to the online state.

**Note:** In addition to viewing administration alerts on the **Admin Alerts** page, you can configure the system to send alerts to an e-mail address (see [Recipients on page 304](#)).

To access the **Admin Alerts** page, click the **Alerts** menu, and then click the **Admin Alerts** tab (see [Figure 129 below](#)).

**Figure 129:** Admin Alerts Page

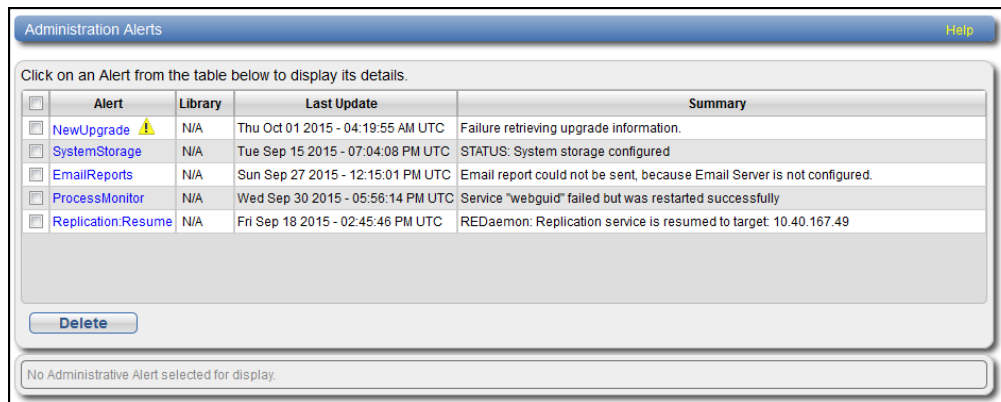

<input type="checkbox"/>	Alert	Library	Last Update	Summary
<input type="checkbox"/>	<a href="#">NewUpgrade</a> 	N/A	Thu Oct 01 2015 - 04:19:55 AM UTC	Failure retrieving upgrade information.
<input type="checkbox"/>	<a href="#">SystemStorage</a>	N/A	Tue Sep 15 2015 - 07:04:08 PM UTC	STATUS: System storage configured
<input type="checkbox"/>	<a href="#">EmailReports</a>	N/A	Sun Sep 27 2015 - 12:15:01 PM UTC	Email report could not be sent, because Email Server is not configured.
<input type="checkbox"/>	<a href="#">ProcessMonitor</a>	N/A	Wed Sep 30 2015 - 05:56:14 PM UTC	Service "webguid" failed but was restarted successfully
<input type="checkbox"/>	<a href="#">Replication.Resume</a>	N/A	Fri Sep 18 2015 - 02:45:46 PM UTC	REDaemon: Replication service is resumed to target: 10.40.167.49

No Administrative Alert selected for display.

The **Admin Alerts** page displays the following information about administration alerts:

<b>Alert</b>	The name of the administration alert.
<b>Library</b>	The library or partition where the admin alert was generated.
<b>Last Update</b>	The date when the administration alert was last updated by the system.
<b>Summary</b>	A brief description of the administration alert.

**Note:** Click a column heading to sort the rows in the table by that column. Click the column heading again to reverse the sort order.

Use the **Admin Alerts** page to perform the following tasks:

- To view details about an administration alert, click the alert name. Detailed information about the alert appears in the **Activity Status History** section.
- To delete an administration alert, select it and click **Delete**.

# Service Tickets

The DXi6900 has the capability to automatically detect and resolve problems encountered by the system during operation. If a problem cannot be resolved automatically and requires user intervention or servicing, the system generates a service ticket.

A service ticket contains detailed information about the problem and, if appropriate, steps you can take to resolve it. If the DXi6900 detects that the problem is resolved, the system automatically closes the service ticket. You can also manually close a service ticket after the problem is corrected.

**Note:** Tickets that are not resolved are generated again after 24 hours.

See the following sections for more information about service tickets:

## Service Ticket Priority

The system assigns each service ticket a priority based on the criticality of the problem that caused the system to generate the ticket. There are three priority levels:

Priority Level	Description
<b>Low</b>	A minor problem occurred and needs to be resolved, but the operation and performance of the DXi6900 are not significantly affected.
<b>Middle</b>	A serious problem occurred and needs to be resolved, but it does not necessarily need to be fixed immediately. The operation and performance of the DXi6900 may be degraded.
<b>High</b>	A critical problem has occurred and needs to be resolved immediately. The operation and performance of the DXi6900 are degraded, and there is a risk of system failure or data loss.

## Recommended Actions

If appropriate, a service ticket includes recommended actions. The recommended actions provide instructions for resolving the problem that caused the system to generate the ticket.

Perform the recommended actions to try to resolve the problem before contacting Quantum customer support. If you are able to resolve the problem, you can close the service ticket.

**Note:** The recommended actions should be performed by a user who is familiar with operating the DXi6900.

## Working With Service Tickets

The **Service Tickets** page allows you to view and work with service tickets.

To access the **Service Tickets** page, click the **Alerts** menu, and then click the **Service Tickets** tab (see [Figure 130 below](#)).

**Figure 130:** Service Tickets Page

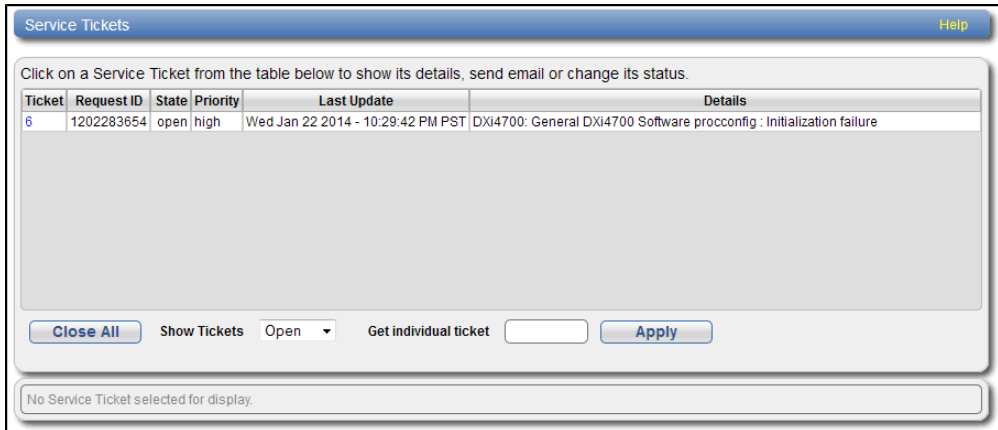

The **Service Tickets** page displays the following information about open service tickets:

<b>Ticket</b>	The service ticket number.
<b>Request ID</b>	The Request ID of the ticket.
<b>State</b>	The current status of the service ticket ( <b>Open</b> or <b>Closed</b> ).
<b>Priority</b>	The priority level of the service ticket ( <b>Low</b> , <b>Middle</b> , or <b>High</b> ).
<b>Last Update</b>	The date when the service ticket was last updated by the system.
<b>Details</b>	A brief description of the service ticket.
<b>Close All</b>	Click to close all open service tickets.
<b>Show Tickets</b>	Select an option to display <b>Open</b> tickets, <b>Closed</b> tickets, or <b>All</b> tickets.
<b>Get individual ticket</b>	To display a specific ticket in the list, enter a ticket number and click <b>Apply</b> .

**i Note:** Click a column heading to sort the rows in the table by that column. Click the column heading again to reverse the sort order.

### Tasks

Use the **Service Tickets** page to perform the following tasks:



- View details for a service ticket, including recommended actions (see [Viewing a Service Ticket below](#)).
- Add information to a service ticket (see [Viewing a Service Ticket below](#)).
- Send a service ticket to an e-mail address (see [Sending a Service Ticket on page 212](#)).
- Close a service ticket that has been resolved (see [Closing a Service Ticket on page 213](#)).

## Viewing a Service Ticket

View a service ticket to see detailed information about the problem that caused the system to generate the ticket and to view recommended actions.

To view a service ticket:

1. In the list of service tickets, click the ticket number.

The **Ticket Details** section at the bottom of the page displays information about the service ticket, including the time the ticket was opened and closed, the ticket status, and detailed information about the problem (see [Figure 131 on the next page](#)).

---

**i Note:** The time indicated in the service ticket may not match the DXi6900 system time.

Figure 131: Ticket Details

The screenshot shows a web interface for managing service tickets. At the top, there is a header bar with the text "Service Tickets" and a "Help" link. Below the header, a message reads: "Click on a Service Ticket from the table below to show its details, send email or change its status." A table with the following columns is displayed: Ticket, Request ID, State, Priority, Last Update, and Details. The table contains one row with the following data: Ticket 205, Request ID 1315268066, State open, Priority middle, Last Update Thu Jul 30 2015 - 04:50:54 AM PDT, and Details Space Manager daemon : System resource warning. Below the table, there are several controls: a "Close All" button, a "Show Tickets" button, a dropdown menu currently set to "Open", a "Get individual ticket" button with an adjacent input field, and an "Apply" button. The main content area below is titled "Ticket Details" and shows information for ticket 205. It includes the Request ID 1315268066 and a list of events. The first event is "Opened At: Thu Jul 30 2015 - 02:12:21 AM PDT" with a "Summary" of "Space Manager daemon : System resource warning". The second event is "Thu Jul 30 2015 - 04:50:54 AM PDT" with a "Summary" of "Space Manager daemon : System resource warning" and "Details" stating "Available Disk Space of 1 percent has reached or crossed the hard limit of 5 percent." Below this, there is a link for "View Recommended Actions". The third event is "Thu Jul 30 2015 - 02:12:21 AM PDT" with a "Summary" of "Space Manager daemon : I/O Write Low Threshold state". At the bottom of the details section, there are "Analysis" and "Email" buttons.

Ticket	Request ID	State	Priority	Last Update	Details
205	1315268066	open	middle	Thu Jul 30 2015 - 04:50:54 AM PDT	Space Manager daemon : System resource warning

Ticket Details

Ticket 205 : Request ID 1315268066

Opened At: Thu Jul 30 2015 - 02:12:21 AM PDT  
 Closed At: Open  
 Closed By: Open  
 Priority: middle  
 Summary: Space Manager daemon : System resource warning

Thu Jul 30 2015 - 04:50:54 AM PDT  
 Summary:  
 Space Manager daemon : System resource warning  
 Details:  
 Available Disk Space of 1 percent has reached or crossed the hard limit of 5 percent.  
[View Recommended Actions](#)

Thu Jul 30 2015 - 02:12:21 AM PDT  
 Summary:  
 Space Manager daemon : I/O Write Low Threshold state

Analysis Email

2. (Optional) Click **View Recommended Actions** to view instructions for resolving the problem.

The recommended actions display in a new Web browser window (see [Figure 132 on the next page](#)). Follow the instructions to resolve the problem. When you are finished, click the close button **[x]** on the upper right corner of the window.

Figure 132: Recommended Actions

Recommended Actions	
Quota Limit or Fragmentation Warnings	
IF	THEN
You receive a warning that the quota hard limit is reached for a user:	Either increase the user's quota, or notify the user.
You receive a warning that fragmentation has been detected in an inode:	<ol style="list-style-type: none"> <li>1. Consult the snfsdefrag man page for instructions on performing fragmentation analysis and defragmenting files.</li> <li>2. See ExtentCountThreshold in the cvfs_config documentation for information on adjusting this RAS event.</li> </ol>
The problem <b>IS</b> resolved:	Close the service ticket. Refer to <a href="#">Closing Service Tickets</a> .
The problem is <b>NOT</b> resolved:	<ol style="list-style-type: none"> <li>1. Modify the ticket according to the troubleshooting steps taken. Refer to <a href="#">Analyzing Service Tickets</a>.</li> <li>2. Contact the Quantum Technical Assistance Center. <ul style="list-style-type: none"> <li>In the USA: 1+800-284-5101</li> <li>UK, France and Germany: 00800 4 QUANTUM</li> <li>EMEA: +49 6131 3241 1164 / Asia Pacific: +603 7953 3010</li> <li>On the Web: <a href="http://www.quantum.com/support">http://www.quantum.com/support</a></li> </ul> </li> </ol>
<a href="#">Print Document</a>   <a href="#">Close Window</a>	
<small>©2010 Quantum Corporation © All rights reserved.</small>	

## Modifying a Service Ticket

Modify a service ticket to add additional information to the ticket, for example, troubleshooting steps you have taken or a record of calls made to Quantum customer support. The additional information is saved with the service ticket and remains associated with the ticket even after it is closed.

To modify a service ticket:

1. In the list of service tickets, click the ticket number.
2. Click **Analysis** at the bottom of the page.

The **Ticket Analysis** section displays at the bottom of the page (see [Figure 133 on the next page](#)).

Figure 133: Ticket Analysis

The screenshot shows a web interface for managing service tickets. At the top, there is a header bar with the text "Service Tickets" and a "Help" button. Below the header, there is a instruction: "Click on a Service Ticket from the table below to show its details, send email or change its status." A table with the following columns is displayed: Ticket, Request ID, State, Priority, Last Update, and Details. The table contains one row with the following data: Ticket 205, Request ID 1315268066, State open, Priority middle, Last Update Thu Jul 30 2015 - 04:50:54 AM PDT, and Details Space Manager daemon : System resource warning. Below the table, there are several controls: a "Close All" button, a "Show Tickets" button, a dropdown menu set to "Open", a "Get individual ticket" button with an input field, and an "Apply" button. Below these controls, there is an "Analysis" section. It shows "Ticket 205" and "Request ID 1315268066". There are two bullet points: "Enter relevant information to save regarding the ticket(s)." and "Check 'Close Ticket' to close the ticket when the issue is resolved." Below this is an "Analysis Information" section with a large text input area. At the bottom of the analysis section, there are "Apply" and "Cancel" buttons, and a checkbox labeled "Close Ticket".

Ticket	Request ID	State	Priority	Last Update	Details
205	1315268066	open	middle	Thu Jul 30 2015 - 04:50:54 AM PDT	Space Manager daemon : System resource warning

3. In the **Analysis Information** box, enter all relevant information about actions taken to resolve the issue.
4. Click **Apply**.

### Sending a Service Ticket

Send a service ticket to send the ticket details to an e-mail address. You can also add optional comments to the e-mail.

**i Note:** To enable the DXi6900 to send e-mail, you must specify an outgoing e-mail server (see [Server on page 308](#)).

To send a service ticket:

1. In the list of service tickets, click the ticket number.
2. Click **Email** at the bottom of the page.

The **Email Ticket Information** section displays at the bottom of the page (see [Figure 134 on the next page](#)).

**Figure 134: Email Ticket Information**

The screenshot shows a web interface titled "Service Tickets" with a "Help" button in the top right. Below the title bar, there is a text instruction: "Click on a Service Ticket from the table below to show its details, send email or change its status." Below this is a table with the following data:

Ticket	Request ID	State	Priority	Last Update	Details
205	1315268066	open	middle	Thu Jul 30 2015 - 04:50:54 AM PDT	Space Manager daemon : System resource warning

Below the table are several controls: a "Close All" button, a "Show Tickets" button, a dropdown menu set to "Open", a "Get individual ticket" button with an adjacent input field, and an "Apply" button. Below these controls is a section titled "Email Ticket Information" which contains the following fields and instructions:

Ticket 205 | Request ID 1315268066

- Enter the email address where you wish to send the ticket details.
- Enter an optional comment to be included.

Email Recipient:

Comment:

Buttons: "Send" and "Cancel"

3. In the **Email Recipient** box, enter the e-mail address where you want to send the ticket details.
4. (Optional) In the **Comment** box, enter additional information to send with the ticket.
5. Click **Send**.

### Closing a Service Ticket

Close a service ticket if the problem the caused the system to generate the ticket is resolved. You can also close all service tickets that are currently open.

**i Note:** You can still view and modify a ticket after it has been closed.

To close all service tickets that are currently open, below the list of service tickets, click **Close All**.

To close a single service ticket:

1. In the list of service tickets, click the ticket number.
2. Click **Analysis** at the bottom of the page.
3. The **Ticket Analysis** section displays at the bottom of the page..
4. Select the **Close Ticket** check box.
5. Click **Apply**.



## Chapter 9: Configuration

---

This chapter contains the following topics:

DXi6900 Configuration Overview .....	214
NAS Configuration .....	215
VTL Configuration .....	231
OST Configuration .....	257
Replication Configuration .....	282
PTT Configuration .....	291
Scheduler .....	297
Notifications .....	304
System .....	321
Contacts .....	363

---

### DXi6900 Configuration Overview

The **Configuration** page allows you to configure the features of the DXi6900, including storage presentation, data replication, path to tape, system settings, and notifications.

To access the **Configuration** page, click the **Configuration** menu.

The **Configuration** page contains the following tabs:

- [NAS](#)
- [VTL](#)
- [Replication Configuration](#)
- [OST](#) (including DXi Accent with OST)
- [PTT](#)
- [Scheduler](#)
- [System](#)
- [Notifications](#)
- [Contacts](#)

---

## NAS Configuration

The **NAS** page allows you to configure the DXi6900 to present its storage capacity as NAS (network attached storage) shares that are compatible with standard backup applications. You can create NAS shares for use with Windows or Linux networks. You can also join the DXi6900 to a Windows domain or workgroup and manage users.

### Additional Information

- The **NAS** wizard provides guided assistance for configuring NAS shares (see [Configuration Wizards on page 79](#)).

 **Caution:** Filenames on NAS shares are limited to a length of 256 bytes. If a filename uses Japanese characters, the filename can be no longer than 85 characters. This is because each Japanese character is represented by 3 bytes.

To access the **NAS** page, click the **Configuration** menu, and then click the **NAS** tab.

The **NAS** page contains the following tabs:

- [NAS Summary on the next page](#)
- [Windows Domain on page 223](#)
- [Share Access on page 225](#)
- [Advanced Setting on page 230](#)

# NAS Summary

The **NAS Summary** page allows you to manage NAS shares on the DXi6900. You can view information about existing shares, add or edit shares, and delete shares.

To access the **NAS Summary** page, on the **NAS** page, click the **Summary** tab (see [Figure 135 below](#) and [Figure 136 below](#)).

**Figure 135:** DXi6900 NAS Summary Page

Share Name	Protocol	Export Path	Permissions	Access	Deduplication	Replication	Targets	Description
dvt-rocky1e_army1_nfs01	NFS (sync)	/Q/shares/dvt-rocky1e_army1_nfs01	Read & Write	All hosts	Enabled	Receive Sync ID: dvt-rocky1e_army1_nfs01		
dvt-rocky1e_army1_nfs02	NFS (sync)	/Q/shares/dvt-rocky1e_army1_nfs02	Read & Write	All hosts	Enabled	Receive Sync ID: dvt-rocky1e_army1_nfs02		
dvt-rocky1e_army1_nfs03	NFS (sync)	/Q/shares/dvt-rocky1e_army1_nfs03	Read & Write	All hosts	Enabled	Receive Sync ID: dvt-rocky1e_army1_nfs03		
dvt-rocky1e_army1_nfs04	NFS (sync)	/Q/shares/dvt-rocky1e_army1_nfs04	Read & Write	All hosts	Enabled	Receive Sync ID: dvt-rocky1e_army1_nfs04		
dvt-rocky1e_army2_nfs01	NFS (sync)	/Q/shares/dvt-rocky1e_army2_nfs01	Read & Write	All hosts	Enabled	Receive Sync ID: dvt-rocky1e_army2_nfs01		
dvt-rocky1e_army2_nfs02	NFS (sync)	/Q/shares/dvt-rocky1e_army2_nfs02	Read & Write	All hosts	Enabled	Receive Sync ID: dvt-rocky1e_army2_nfs02		
dvt-rocky1e_army2_nfs03	NFS (sync)	/Q/shares/dvt-rocky1e_army2_nfs03	Read & Write	All hosts	Enabled	Receive Sync ID: dvt-rocky1e_army2_nfs03		
dvt-rocky1e_army2_nfs04	NFS (sync)	/Q/shares/dvt-rocky1e_army2_nfs04	Read & Write	All hosts	Enabled	Receive Sync ID: dvt-rocky1e_army2_nfs04		
dvt-rocky1e_artanis_cifs01	CIFS	dvt-rocky1e_artanis_cifs01	Read & Write	All users	Enabled	Receive Sync ID: dvt-rocky1e_artanis_cifs01		

**Figure 136:** DXi6900-S NAS Summary Page

Share Name	Protocol	Export Path	Permissions	Access	Deduplication	Replication	Targets	Description
testAppSpec1	Application Specific	testAppSpec1	Read & Write	All hosts	Enabled	Send Sync ID: testAppSpec1	10.40.166.123	
testNfs1	NFS (sync)	/Q/shares/testNfs1	Read Only	All hosts	Disabled	N/A		
testNfsShare1	NFS (sync)	/Q/shares/testNfsShare1	Read & Write	All hosts	Enabled	<a href="#">Configure</a>		

## Tasks

Use the **NAS** page to perform the following tasks:

- View information about existing NAS shares (see [NAS Shares List on the next page](#)).
- Add a new NAS share to the system (see [Adding a NAS Share on page 218](#)).
- Edit properties for an existing NAS share (see [Editing a NAS Share on page 221](#)).
- Delete a NAS share from the system (see [Deleting a NAS Share on page 222](#)).



## NAS Shares List

The **NAS Shares List** section displays the following information for all NAS shares on the DXi6900:

<b>Shares</b>	The number of shares that have been added to the system.
<b>Maximum</b>	The maximum number of shares that can be added to the system.
<b>NFS</b>	The number of existing shares configured to use the NFS protocol (for Linux networks).
<b>CIFS/SMB</b>	The number of existing shares configured to use the CIFS/SMB protocol (for Windows networks).
<b>Application Specific</b>	(DXi6900-S) The number of existing shares configured to use Oracle Recovery Manager (RMAN).
<b>Share Name</b>	The name of the share.
<b>Protocol</b>	<p>(DXi6900) The protocol (<b>CIFS</b> or <b>NFS</b>) the share is configured to use.</p> <p>(DXi6900-S) The protocol (<b>CIFS/SMB</b>, <b>NFS</b>, or <b>Application Specific (RMAN)</b>) the share is configured to use.</p> <p>For NFS shares, the <b>Protocol</b> column displays the commit type of the share (<b>sync</b> for synchronous or <b>async</b> for asynchronous). For information about changing the commit type of NFS shares, see the <i>DXi-Series Command Line Interface (CLI) Guide</i>.</p>
<b>Export Path</b>	The export path of the share (different for CIFS/SMB, NFS, and Application Specific (RMAN) shares).
<b>Permissions</b>	The permissions in use on the share ( <b>Read &amp; Write</b> or <b>Read Only</b> ).
<b>Access</b>	The access type of the share ( <b>all hosts</b> or specific users).
<b>Deduplication</b>	The data deduplication state of the share ( <b>Enabled</b> or <b>Disabled</b> ).
<b>Replication</b>	<p>The current state of replication for the share:</p> <ul style="list-style-type: none"><li>• <b>Enabled</b> - Replication is enabled.</li><li>• <b>Send/Receive Sync ID</b> - Directory/File Based Replication is enabled.</li><li>• <b>Configure</b> - Click to configure replication for the share (see <a href="#">Editing a NAS Share on page 221</a>)</li><li>• <b>Scheduled</b> - Replication is scheduled for the share. Click to view or modify the schedule (see <a href="#">Scheduling a Share or Partition for Replication on page 300</a>).</li></ul>

---

<b>Targets</b>	The targets the share is configured to replicate to.
<b>Description</b>	A brief description of the NAS share (if available).

---

### Additional Information

- Click a column heading to sort the rows in the table by that column. Click the column heading again to reverse the sort order.
- Click the Information button **[i]** next to a share to display detailed information about the share and recent replication activity.

## Adding a NAS Share

Add a NAS share to present the storage capacity of the DXi6900 as a NAS share that is compatible with standard backup applications. You can add up to 128 shares. When you add a share, you must specify whether it uses the NFS protocol (for Linux networks) or the CIFS/SMB protocol (for Windows networks).

**i Note:** If you are adding a CIFS/SMB share for use with a Windows network, you must configure the Windows domain before adding the new share (see [Windows Domain on page 223](#)).

To add a NAS share:

1. Click **Add**.

The **Add NAS Share** page displays (see [Figure 137 below](#) and [Figure 138 on the next page](#)).

**Figure 137:** DXi6900 Add NAS Share Page

The screenshot shows the 'Add NAS Share' configuration window. It has a title bar with 'Add NAS Share' and a 'Help' link. The window is split into two panes. The left pane, 'NAS Share Settings', contains a text box for 'Name', a text box for 'Description', and a section for 'Options' with checkboxes for 'Hide from network browsing' and 'Enable deduplication'. Below that is the 'Export Protocol' section with radio buttons for 'CIFS (Windows network)' and 'NFS (UNIX/Linux network)'. The right pane, 'Replication Settings', has a 'Send' section with a checkbox for 'Enable replication to the replication target DXI' and a sub-section for 'Enable Directory/File Based replication to target' with a 'Sync ID' field. Below this is a table with columns 'Replication Target DXIs', 'Status', and 'Encryption'. The table has two rows: one with 'Ready' status and 'AES 256-bit' encryption, and another with 'System Paused' status and 'AES 256-bit' encryption. The 'Receive' section has a checkbox for 'Enable Directory/File Based replication to this DXI' and another 'Sync ID' field. At the bottom of the right pane are 'Access' radio buttons for 'Locked' and 'Unlocked'. At the very bottom of the window are three buttons: 'Apply', 'Reset', and 'Cancel'.

**Figure 138:** DXi6900-S Add NAS Share Page

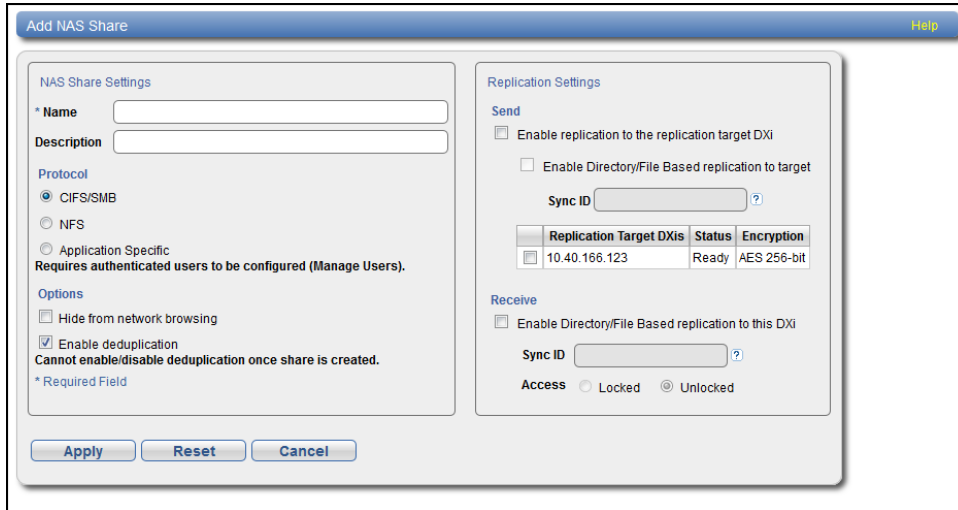

2. Under **NAS Share Settings**, enter information about the share:

**DXi6900-S**

<b>Name</b>	Enter the name of the NAS share.  <b>i Note:</b> NAS share names are not case-sensitive. For example, if you create a share named <b>nas1</b> , you cannot create another share named <b>NAS1</b> because the system considers the names to be the same.
<b>Description</b>	(Optional) Enter a brief description of the share.
<b>Protocol</b>	Select the export protocol for the share: <ul style="list-style-type: none"> <li>• <b>CIFS/SMB</b> - Select the CIFS/SMB option to use the share on a Windows network.</li> <li>• <b>NFS</b> - Select the NFS option to use the share on a UNIX or Linux network.</li> <li>• <b>Application Specific</b> - Select the Application Specific option to create an Oracle RMAN share.</li> </ul>
<b>Hide from network browsing</b>	(CIFS/SMB shares only) Select the check box to hide the share from network browsing. If selected, you cannot see the share when browsing the network.

---

**Enable deduplication**

(CIFS/SMB/NFS shares only) Select the check box to enable data deduplication. Quantum recommends that you enable data deduplication to optimize disk usage.

**i Note:** Data deduplication is enabled by default. You cannot enable or disable data deduplication after the share is added. If data duplication is disabled, then data compression is also disabled.

**i Note:** Deduplication of Application Specific shares is enabled by default.

---

**DXi6900**

---

**Name**

Enter the name of the NAS share.

**i Note:** NAS share names are not case-sensitive. For example, if you create a share named **nas1**, you cannot create another share named **NAS1** because the system considers the names to be the same.

---

**Description**

(Optional) Enter a brief description of the share.

---

**Hide from network browsing**

(CIFS shares only) Select the check box to hide the share from network browsing. If selected, you cannot see the share when browsing the network.

---

**Enable deduplication**

Select the check box to enable data deduplication. Quantum recommends that you enable data deduplication to optimize disk usage.

**i Note:** Data deduplication is enabled by default. You cannot enable or disable data deduplication after the share is added. If data duplication is disabled, then data compression is also disabled.

---

**Export Protocol**

Select the export protocol for the share:

- **CIFS** - Select the CIFS option to use the share on a Windows network (DXi6900 G1/G2).
  - **NFS** - Select the NFS option to use the share on a UNIX or Linux network.
- 

3. (Optional) Under **Replication Settings**, specify replication settings.

For more information about configuring replication for a share, or to set up replication for the share at a later time, see [Replication on page 138](#).

4. Click **Apply**.

## Additional Information

When you create a CIFS/SMB share, the initial permissions are the same as the default permissions for a Windows 2003 share with the addition of an ACE (Access Control Entry) that permits full access to the share for all authenticated users. Administrators can choose to remove this full access ACE, set up custom permissions, or leave the ACL (Access Control List) as it is if the server is set up in a fully trusted environment.

## Editing a NAS Share

Edit a NAS share to modify the settings for the share, for example, to change the description of the share or to select different options.

To edit a NAS share:

1. Select the share and click **Edit**.

The **Edit NAS Share & Replication Settings** page displays (see [Figure 139 below](#)).

**Figure 139:** Edit NAS Share & Replication Settings Page

Replication Target DXIs	Status	Encryption
<input checked="" type="checkbox"/> 10.10.10.10	Ready	AES 256-bit
<input checked="" type="checkbox"/> 10.10.10.10	System Paused	AES 256-bit

2. Under **NAS Share Settings**, enter information about the share:

**Note:** If you are editing a share, only the **Description**, **Enforce read-only access**, **Hide from network browsing**, and **Allow all users to access this share** options can be changed.

---

### Description

(Optional) Enter a brief description of the share.

---

---

<b>Enforce read-only access</b>	(CIFS/SMB and NFS shares only) Select the check box to make the share read only. If selected, you cannot write to the share.
<b>Hide from network browsing</b>	(CIFS/SMB shares only) Select the check box to hide the share from network browsing. If selected, you cannot see the share when browsing the network.
<b>Allow all hosts to access this share</b>	(NFS shares only) Select this check box to allow all hosts (NFS shares) to access the share.  Or clear the check box to allow only specified users or hosts to access the share. To add a user or host to the access list, click <b>Add</b> . Specify the <b>Hostname or IP Address</b> (NFS shares) and the associated permissions ( <b>Read Only</b> or <b>Read &amp; Write</b> ), and then click <b>Apply</b> .

---

#### Additional Information

- To modify the users that are available in the **Workgroup User** list, see [Share Access on page 225](#).
- After you add a user or host to the access list, you cannot change their permissions. Instead, select the user or host in the access list and click **Delete** to remove them from the list. Then add the user or host again with the correct permissions.

3. (Optional) Under **Replication Settings**, specify replication settings.

For more information about configuring replication for a share, or to set up replication for the share at a later time, see [Replication on page 138](#).

4. Click **Apply**.

#### Additional Information

If you modify a NAS share that uses the CIFS/SMB protocol, you must restart the CIFS/SMB service for the changes to take effect. To restart the CIFS/SMB service, first disjoin the Windows workgroup, then join it again (see [Windows Domain on the next page](#)). Restarting the CIFS/SMB service will close all active connections to the share. Most Windows workstations will automatically reconnect, but some applications may be affected.

## Deleting a NAS Share

Delete a NAS share if it is no longer needed. When you delete a share, all data stored on the share is lost, and any schedules associated with the share are deleted.

**i Note:** If you delete a share configured for Directory/File Based Replication on the source DXi, the share is *not* automatically deleted on the target DXi. If you do not want to retain the share on the target DXi, you can manually delete it.

To delete a NAS share:

1. Select the share and click **Delete**. You can select multiple shares to delete at once.
2. Click **Yes** to confirm the deletion.

## Windows Domain

The **Windows Domain** page allows you to join the DXi6900 to a Windows workgroup or a Windows domain using **SMB**. To use a NAS share configured for the CIFS/SMB protocol on a Windows network, you must first join the DXi6900 to a workgroup or a domain. After you join the DXi6900 to a workgroup or a domain, CIFS/SMB shares are available for use on the Windows network.

To access the **Windows Domain** page, on the **NAS** page, click the **Windows Domain** tab (see [Figure 140 below](#)).

**Figure 140:** Windows Domain Page

Windows Domain Help

This DXi has not joined a Windows Domain

\* Domain Type

\* Domain/Workgroup Name

Primary Domain Controller

Use DNS Discovery

Specify Address

Organization Unit

\* Administrator Name

\* Administrator Password

\* Required Field

### Tasks

Use the **Windows Domain** page to perform the following tasks:

- Join the DXi6900 to a Windows workgroup (see [Joining a Windows Workgroup on the next page](#)).
- Join the DXi6900 to a Windows domain (see [Joining a Windows Domain on the next page](#)).

- Remove the DXi6900 from a Windows workgroup or domain (see [Disjoining a Workgroup or Domain on the next page](#)).

## Joining a Windows Workgroup

Join a Windows workgroup to add the DXi6900 to a workgroup on a Windows network. After you join a workgroup, CIFS/SMB shares are available for use on the Windows network.

To join a Windows workgroup:

1. Enter the following information about the Windows domain:

<b>Domain Type</b>	Select Workgroup.
<b>Domain/Workgroup Name</b>	Enter the workgroup name.  The workgroup name can be the name of an existing workgroup or a new workgroup (for example, <b>Workgroup</b> or <b>Sales</b> ).

2. Click **Apply**.

### Additional Information

When an SMB server is joined to a workgroup, share security is managed directly from the remote management console. For a CIFS/SMB share, security is provided through the read only or read/write access to the share. By default, when a CIFS/SMB share is created, the default security setting allows access for all users. Any access restrictions on individual users can be managed by editing a share on the NAS Summary page (see [Editing a NAS Share on page 221](#)).

## Joining a Windows Domain

Join a Windows domain to add the DXi6900 to a Windows network using Active Directory. After you join a domain, CIFS/SMB shares are available for use on the Windows network.

Before joining a Windows domain, make sure the date and time on the DXi6900 is correct and is synchronized with the Active Directory Services (ADS) server (see [Date & Time on page 333](#)). The time difference between the DXi6900 and the ADS server (domain controller) must be less than 300 seconds. Quantum recommends using the same NTP server for the DXi6900 and the ADS server to keep them synchronized.

To join a Windows domain:



1. Enter the following information about the Windows domain:

<b>Domain Type</b>	Select <b>Active Directory</b> .
<b>Domain/Workgroup Name</b>	Enter the domain name.
<b>Primary Domain Controller</b>	Select an option for the Primary Domain Controller (PDC): <ul style="list-style-type: none"><li>• <b>Use DNS Discovery</b> - Discover the PDC automatically.</li><li>• <b>Specify Address</b> - Enter the fully qualified name or the IP address of the PDC.</li></ul>
<b>Organization Unit</b>	(Optional) Enter the name of the organizational unit in the domain. The DXi6900 will become a member of this organization.
<b>Administrator Name</b>	Enter <b>Administrator</b> or any user that has the right to join the domain.  By default, any user belonging to the <b>Administrators</b> group or the <b>Domain Admins</b> group has the right to join the domain. In addition, any user can join the domain if they are specifically delegated this right by a member of the <b>Administrators</b> group.
<b>Administrator Password</b>	Enter the password for the user entered above.

2. Click **Apply**.

### Additional Information

When the system is joined to the Active Directory domain, share security is managed by the MMC (Microsoft Management Console) that is running on the domain controller. By default, when a CIFS/SMB share is created, the default security setting allows access for all users. Any access restrictions on individual users must be managed from the MMC.

## Disjoining a Workgroup or Domain

Disjoin a workgroup or a domain to remove the DXi6900 from a Windows workgroup or domain. After you disjoin the workgroup or domain, CIFS/SMB shares are no longer available for use on the Windows network

To disjoin a workgroup or domain, click **Disjoin**.

## Share Access

The **Share Access** page allows you to manage workgroup users when the DXi6900 is joined to a Windows workgroup, or manage share administrators when the DXi6900 is joined to a Windows domain using Active Directory. You can add users or administrators, change user privileges, and delete users or administrators. Available users or administrators can be granted access to NAS shares configured for the CIFS/SMB protocol.

**i Note:** You must join a Windows workgroup or domain before you can add workgroup users or share administrators (see [Windows Domain on page 223](#)). The **Share Access** page is different depending on whether the DXi is joined to a workgroup or domain.

To access the **Share Access** page, on the **NAS** page, click the **Share Access** tab (see [Figure 141 below](#) and [Figure 142 below](#)).

**Figure 141:** Share Access Page (Windows Workgroup)

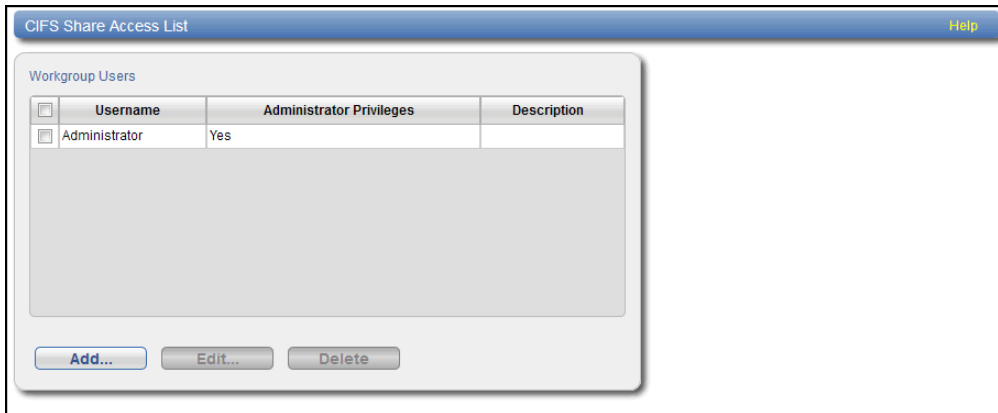

**Figure 142:** Share Access Page (Active Directory)

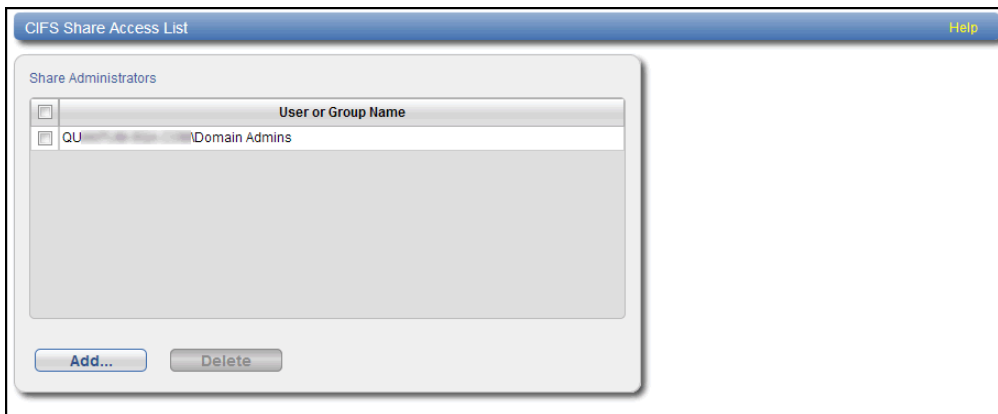

## Tasks

Use the **Share Access** page to perform the following tasks:

- View information about workgroup users or share administrators (see [Workgroup Users or Share Administrators on the next page](#)).
- Add a workgroup user or a share administrator (see [Adding a Workgroup User or Share Administrator on the next page](#)).
- Edit a workgroup user (see [Editing a Workgroup User on page 228](#)).

- Delete a workgroup user or a share administrator (see [Deleting a Workgroup User or Share Administrator on page 229](#)).

## Workgroup Users or Share Administrators

If the DXi6900 is joined to a Windows workgroup, the **Workgroup Users** section displays the following information about workgroup users:

<b>Username</b>	The name of the workgroup user.
<b>Administrator Privileges</b>	The privileges of the workgroup user ( <b>Yes</b> if the user has administrator privileges, <b>No</b> if they do not.)
<b>Description</b>	A brief description of the workgroup user (if available).

If the DXi6900 is joined to a Windows domain using Active Directory, the **Share Administrators** section displays the following information about share administrators:

<b>User or Group Name</b>	The fully qualified name of the user or group.
---------------------------	--

## Adding a Workgroup User or Share Administrator

Add a workgroup user or share administrator to be able to grant that user or administrator access to CIFS/SMB shares.

### Windows Workgroup

To add a workgroup user for a Windows workgroup:

1. Click **Add**.

The **Add Workgroup User** page displays (see [Figure 143 below](#)).

**Figure 143:** Add Workgroup User Page



2. Enter information about the workgroup user:

<b>User Name</b>	Enter the name of the workgroup user.
<b>Password</b>	Enter the password for the workgroup user.
<b>Confirm Password</b>	Enter the password again to confirm it.
<b>Description</b>	(Optional) Enter a brief description of the workgroup user.
<b>Grant Administrator Privileges</b>	Select the check box to add the workgroup user to the Windows Administrators group.  This allows the workgroup user to override certain permissions settings and prevents the workgroup user from being locked out of shares or directories.

3. Click **Apply**.

After you create a workgroup user, you can grant the user access to a NAS share (see [Share Access on page 225](#)).

## Windows Domain

To add a share administrator for a Windows domain:

1. Click **Add**.

The **Add Share Administrator** page displays (see [Figure 144 below](#)).

**Figure 144:** Add Share Administrator Page



2. Enter the **Fully Qualified User or Group Name** of the share administrator.
3. Click **Apply**.

Use the MMC (Microsoft Management Console) to manage users (see [ADS Share Permissions on page 230](#)).

## Editing a Workgroup User

Edit a workgroup user to change the user's password or description, or to change the user's administrator privileges.

**Note:** You cannot edit a share administrator. Instead, delete the share administrator, then add a new share administrator.

To edit a workgroup user:

1. Select the user and click **Edit**.

The **Edit Workgroup User** page displays (see [Figure 145 below](#)).

**Figure 145:** Edit Workgroup User Page

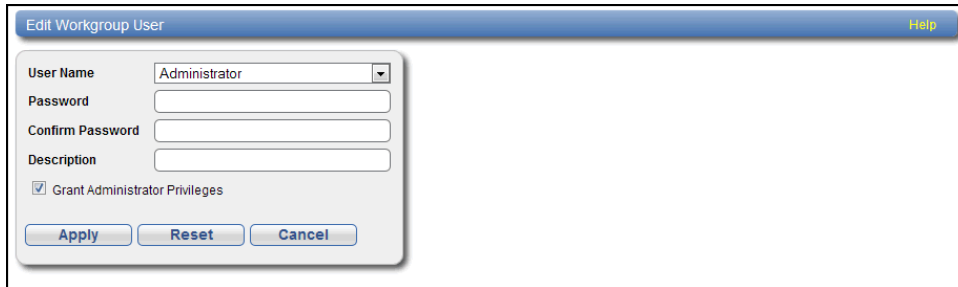

2. Enter information about the workgroup user:

**Note:** If you are editing a workgroup user, you cannot change the **User Name**.

<b>User Name</b>	(Optional) Select a different workgroup user to edit.
<b>Password</b>	Enter the password for the workgroup user.
<b>Confirm Password</b>	Enter the password again to confirm it.
<b>Description</b>	(Optional) Enter a brief description of the workgroup user.
<b>Grant Administrator Privileges</b>	Select the check box to add the workgroup user to the Windows Administrators group.  This allows the workgroup user to override certain permissions settings and prevents the workgroup user from being locked out of shares or directories.

3. Click **Apply**.

## Deleting a Workgroup User or Share Administrator

Delete a workgroup user or share administrator if the user or administrator no longer needs to access CIFS/SMB shares.

To delete a workgroup user or share administrator, select the user or administrator and click **Delete**. You can select multiple users or administrators to delete at once.

## ADS Share Permissions

To manage user access to CIFS/SMB shares when the DXi6900 is joined to a Windows domain, use the MMC (Microsoft Management Console). Log onto the MMC on the domain controller and access a share's properties to set share permissions for users.

### Additional Information

In some cases, when you view file permissions on a Windows system, you will not see the user and group information. Instead you will see the SID (security ID) which appears as a series of numbers. This occurs when you move files (for example, using a backup utility or DOS **xcopy**) from one system to another system, and the user and group from the source system do not exist on the target system.

Often users and groups are unique to a particular scope, such as a Windows system or an ADS domain. As a result, some assigned permissions might not be available on the target system because the associated user and group do not exist there. However, common groups (for example, **Administrators**, **Users**, and **Everyone**) are recognized on most Windows systems and domains.

## Advanced Setting

The **Advanced Setting** page allows you to enable or disable advanced SMB settings.

To access the **Advanced Setting** page, on the **NAS** page, click the **Advanced Setting** tab (see [Figure 146 below](#)).

**Figure 146:** Advanced Setting Page



To enable or disable advanced SMB settings:

1. Select the check box to enable, or clear the check box to disable, the following settings:

**Enable Opportunistic Locking** - (Enabled by default) Opportunistic locking lets clients lock files and locally cache information without the risk of another user changing the file. This increases performance for many file operations, but it may decrease performance in other operations because the server that grants the opportunistic lock must manage the breaking of that lock when another user requests access to the file.

**Note:** System performance may decrease if **Opportunistic Locking** is disabled.

**Enable SMB Server signing** - (Disabled by default) SMB server signing improves security on Windows networks by requiring clients to provide a security signature to connect to a server. If the DXi is joined to a Windows domain that is configured to require signing, you should enable SMB server signing.

2. Click **Apply**.

---

## VTL Configuration

The **VTL** page allows you to configure the DXi6900 to present its storage capacity as VTL (virtual tape library) partitions that are compatible with standard backup applications. You can add virtual tape drives and storage slots to VTL partitions, as well as create and work with virtual tape cartridges. You can also map partitions to hosts.

### Additional Information

The **VTL** wizard provides guided assistance for configuring VTL partitions (see [Configuration Wizards on page 79](#)).

To access the **VTL** page, click the **Configuration** menu, and then click the **VTL** tab.

The **VTL** page contains the following tabs:

- [Partitions below](#)
- [Media on page 240](#)
- [Remote Host Access on page 248](#)

## Partitions

The **Partitions** page allows you to manage VTL partitions on the DXi6900. Use partitions to allocate the DXi6900 virtual tape drives and storage elements to separate partitions that can be accessed by different host systems.

To access the **Partitions** page, on the **VTL** page, click the **Partitions** tab.

The **Partitions** page contains the following tabs:

### Partitions Summary

The **Partitions Summary** page allows you to view information about existing partitions. You can also add or edit partitions, and delete partitions.

To access the **Partitions Summary** page, on the **Partitions** page, click the **Summary** tab (see [Figure 147 below](#)).

**Figure 147:** Partitions Summary Page

The screenshot shows a window titled "Partition List" with a "Help" button in the top right. Below the title bar, it displays "Available Partitions 60 of 64" and "Available Virtual Tape Drives 140 of 160". The main content is a table with the following columns: Name, Mode, Model, Drive Model, Drives, Host Mapping, Media, Slots, Deduplication, Auto Export, Replication, and Targets. There are four rows of data, each with a "vt" prefix in the Name column and a "Configure" link in the Replication column. At the bottom of the window, there are buttons for "Add...", "Edit...", "Delete", "Online", "Offline", and a help icon.

	Name	Mode	Model	Drive Model	Drives	Host Mapping	Media	Slots	Deduplication	Auto Export	Replication	Targets
<input type="checkbox"/>	vt1	Online	Quantum DXi6900	HP LTO-4	5	Yes	500	500	Enabled	Disabled	Enabled	No Targets
<input type="checkbox"/>	vt2	Online	Quantum DXi6900	HP LTO-4	5	Yes	500	500	Enabled	Enabled	<a href="#">Configure</a>	
<input type="checkbox"/>	vt3	Online	ADIC Scalar i2000	HP LTO-3	5	Yes	500	500	Enabled	Enabled	<a href="#">Configure</a>	
<input type="checkbox"/>	vt4	Online	ADIC Scalar i2000	HP LTO-3	5	Yes	500	500	Enabled	Enabled	<a href="#">Configure</a>	

## Tasks

Use the **Partitions Summary** page to perform the following tasks:

- View information about existing VTL partitions (see [Partition List below](#)).
- Add a new VTL partition to the system (see [Adding a VTL Partition on the next page](#)).
- Edit properties for an existing VTL partition (see [Partitions on the previous page](#)).
- Delete a VTL partition from the system (see [Partitions on the previous page](#)).
- Change the mode of a partition (see [Changing Partition Mode on page 240](#)).

## Partition List

The **Partition List** section displays the following information for all VTL partitions on the DXi6900:

<b>Available Partitions</b>	The number of partitions that have been added to the system and the maximum number of partitions that can be added.
<b>Available Virtual Tape Drives</b>	The number of virtual tape drives that have been added to the system and the maximum number of drives that can be added.



<b>Name</b>	The name of the partition.
<b>Mode</b>	The current mode of the partition ( <b>Online</b> or <b>Offline</b> ).
<b>Model</b>	The library model emulated by the partition.
<b>Drive Model</b>	The tape drive model emulated by the virtual drives in the partition.
<b>Drives</b>	The number of virtual tape drives in the partition.
<b>Host Mapping</b>	The current state of host mapping for the partition ( <b>Yes</b> or <b>No</b> ). If no hosts have been mapped, click <b>Map</b> to map hosts to partitions (see <a href="#">Remote Host Mapping on page 249</a> ).
<b>Media</b>	The number of virtual tape cartridges in the partition. If no cartridges have been created, click <b>Create</b> to add media (see <a href="#">Media Add on page 240</a> ).
<b>Slots</b>	The number of storage slots in the partition.
<b>Deduplication</b>	The data deduplication state of the partition ( <b>Enabled</b> or <b>Disabled</b> ).
<b>Auto Export</b>	Auto export state ( <b>Enabled</b> or <b>Disabled</b> ).
<b>Replication</b>	The current state of replication for the partition: <ul style="list-style-type: none"><li>• <b>Enabled</b> - Replication is enabled.</li><li>• <b>Send/Receive Sync ID</b> - Cartridge Based Replication is enabled.</li><li>• <b>Configure</b> - Click to configure replication for the partition (see <a href="#">Partitions on page 231</a>)</li><li>• <b>Scheduled</b> - Replication is scheduled for the partition. Click to view or modify the schedule (see <a href="#">Scheduling a Share or Partition for Replication on page 300</a>).</li></ul>
<b>Targets</b>	The targets the partition is configured to replicate to.

### Additional Information

- Click a column heading to sort the rows in the table by that column. Click the column heading again to reverse the sort order.
- Click the Information button **[i]** next to a partition to display detailed information about the partition and recent replication activity.

### Adding a VTL Partition

Add a VTL partition to present the storage capacity of the DXi6900 as a VTL partition that is compatible with standard backup applications. You can add up to 64 partitions. When you add a partition, you must specify

the type of physical library to emulate and configure virtual tape drives and storage slots.

The number of virtual tape drives (VTDs) totaled across all configured partitions must not exceed a maximum value. The maximum number of VTDs allowed varies depending on the system configuration:

- **DXi6900** - 512 VTDs (no more than 160 VTDs active at any one time)

#### Additional Information

- The maximum number of virtual tape drives allowed per VTL partition is 160 VTDs.
- A license key for 160 VTDs is pre-installed on all DXi6900 models. To obtain a license for additional VTDs, contact Quantum customer support.
- A virtual tape drive is considered active if a cartridge is loaded in the VTD. Make sure to configure the backup application software so that the maximum number of active VTDs is not exceeded at any time. Exceeding the maximum number of active VTDs may cause backup jobs to time out.
- If you plan to replicate partitions to another DXi, make sure that every partition name and barcode number on each DXi is unique. There cannot be duplicate partition names or barcode numbers on the DXi6900 or on a DXi receiving a replicated partition.

---

 **Caution:** Make sure the backup application on the host is configured for the correct number of tape drives and storage slots emulated by the VTL partition. If you do not, the backup application might not operate correctly.

To add a VTL partition:

1. Click **Add**.

The **Add VTL Partition & Replication Settings** page displays (see [Figure 148 on the next page](#)).

**Figure 148:** Add VTL Partition & Replication Settings Page

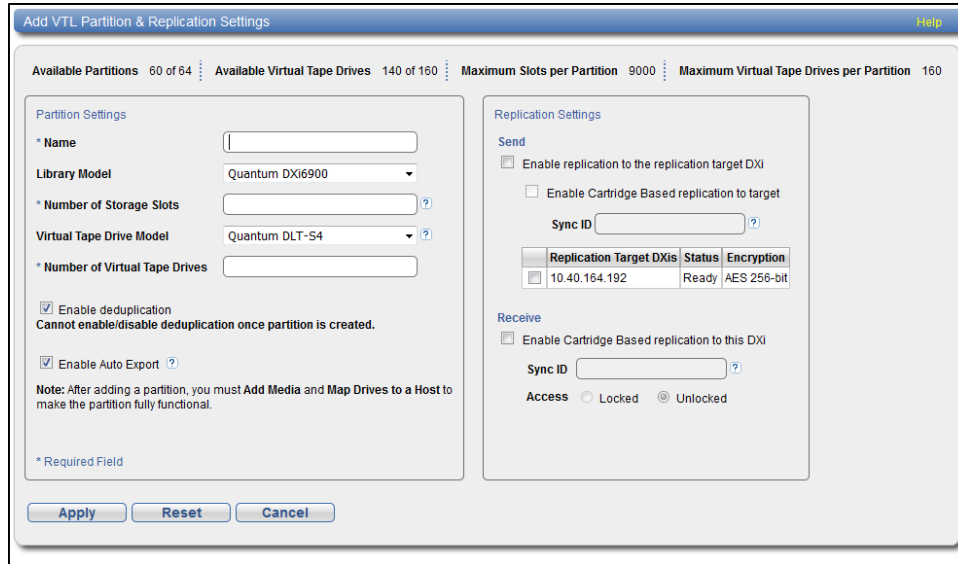

2. Under **Partition Settings**, enter information about the partition:

---

<b>Name</b>	Enter the name of the VTL partition.
-------------	--------------------------------------

---

---

**Library Model**

Select the library model emulated by the partition. The library model determines the inquiry string returned to the host by the DXi6900. (The library model does not restrict the number of slots or drives in a partition because library emulation is not a representation of a physical library.)

The following library models are available:

**Models**

- Quantum DXi7500
- ADIC Pathlight VX
- Quantum Scalar i40/i80 or Quantum Scalar i6000
- Quantum DXi6700, Quantum DXi6900, Quantum DXi6800, Quantum DXi4700, Quantum DXi4601, Quantum, Quantum DXi4500, or Quantum DXi8500
- Quantum DX3000 or Quantum DX5000
- Quantum PX500 or Quantum PX720
- ATL M2500, ATL P1000, or ATL P7000

If you select a library such as the ATL P1000 or ATL P7000, the DXi6900 appears as the selected library to the host and backup application. If you select Quantum DXi6900, the host and backup application recognize the device as a Quantum DXi6900.

**i Note:** Quantum recommends that you set the library model to Quantum DXi6900 for best compatibility. If your backup application does not support the Quantum DXi6900 inquiry string, select a different library model. Check your software compatibility guide to verify what library models are supported.

---

**Number of Storage Slots**

Enter the number of storage slots in the partition (up to 9,000).

**i Note:** One I/E slot is created for each storage slot up to a maximum of 240 I/E slots.

---

---

<b>Virtual Tape Drive Model</b>	<p>- Select the tape drive model emulated by the virtual drives in the partition. All virtual tape drives in a partition must be the same model.</p> <p>The following tape drive models are available:</p> <p><b>Models</b></p> <ul style="list-style-type: none"><li>• Quantum DLT-S4, SDLT600, SDLT320, or DLT7000</li><li>• Certance LTO-2 and LTO-3</li><li>• IBM LTO-1, LTO-2, LTO-3, LTO-4, or LTO-5</li><li>• HP LTO-1, LTO-2, LTO-3, LTO-4, or LTO-5</li></ul>
<b>Number of Virtual Tape Drives</b>	<p>Enter the number of virtual tape drives in the partition.</p> <p><b>i Note:</b> If all tape drives are currently assigned to other partitions, you must remove one or more tape drives from an existing partition to make them available for use in a new partition.</p>
<b>Enable deduplication</b>	<p>Select the check box to enable data deduplication. Quantum recommends that you enable data deduplication to optimize disk usage.</p> <p><b>i Note:</b> Data deduplication is enabled by default. You cannot enable or disable data deduplication after the partition is added. If data duplication is disabled, then data compression is also disabled.</p>
<b>Enable Auto Export</b>	<p>Select the check box to enable Auto Export. When a tape is exported by the backup application, it is placed in a virtual I/E slot. After this, one of the following actions occurs:</p> <ul style="list-style-type: none"><li>• If Auto Export is enabled, the media is removed from the virtual I/E slot.</li><li>• If Auto Export is disabled, the media remains in the virtual I/E slot.</li></ul>

---

3. (Optional) Under **Replication Settings**, specify replication settings.

For more information about configuring replication for a partition, or to set up replication for the partition at a later time, see [Replication on page 138](#).

4. Click **Apply**.

After you add a partition, you must add media and map drives to a host before the partition can be used for backups (see [Media Add on page 240](#) and [Remote Host Mapping on page 249](#)).

### Editing a VTL Partition

Edit a VTL partition to modify the settings for the partition, for example, to change the emulated library model or the number of storage slots and virtual tape drives.

To edit a VTL partition:

1. Select the partition and click **Edit**.

The **Edit VTL Partition & Replication Settings** page displays (see [Figure 149 below](#)).

**Figure 149:** Edit VTL Partition & Replication Settings Page

Available Partitions 60 of 64 Available Virtual Tape Drives 140 of 160 Maximum Slots per Partition 9000 Maximum Virtual Tape Drives per Partition 160

Partition Settings ?

Partition vtl1 is Online.

Name vtl1

Library Model Quantum DXi6900

\* Number of Storage Slots 500

Virtual Tape Drive Model HP LTO-4

\* Number of Virtual Tape Drives 5

Deduplication Enabled

Enable Auto Export

\* Required Field

Replication Settings

Send

Enable replication to the replication target DXI

Enable Cartridge Based replication to target

Sync ID vtl1

Replication Target DXIs	Status	Encryption
<input type="checkbox"/> 10.40.164.192	Ready	AES 256-bit

Receive

Enable Cartridge Based replication to this DXI

Sync ID vtl1

Access  Locked  Unlocked

2. If the partition is online, click **Offline** to take the partition offline. To edit a partition, it must be offline.
3. Under **Partition Settings**, enter information about the partition:

**i Note:** If you are editing a partition, only the **Library Model**, **Number of Storage Slots**, and **Number of Virtual Tape Drives** options can be changed.

---

**Library Model**

Select the library model emulated by the partition. The library model determines the inquiry string returned to the host by the DXi6900.

The following library models are available:

**Models**

- Quantum DXi7500
- ADIC Pathlight VX
- Quantum Scalar i40/i80 or Quantum Scalar i6000
- Quantum DXi6700, Quantum DXi6900, Quantum DXi6800, Quantum DXi4700, Quantum DXi4601, Quantum DXi4500, or Quantum DXi8500
- Quantum DX3000 or Quantum DX5000
- Quantum PX500 or Quantum PX720
- ATL M2500, ATL P1000, or ATL P7000

If you select a library such as the ATL P1000 or ATL P7000, the DXi6900 appears as the selected library to the host and backup application. If you select Quantum DXi6900, the host and backup application recognize the device as a Quantum DXi6900.

---

**i Note:** Quantum recommends that you set the library model to Quantum DXi6900 for best compatibility. If your backup application does not support the Quantum DXi6900 inquiry string, select a different library model. Check your software compatibility guide to verify what library models are supported.

---

**Number of Storage Slots**

Enter the number of storage slots in the partition (up to 9,000).

**i Note:** One I/E slot is created for each storage slot up to a maximum of 240 I/E slots.

---

**Number of Virtual Tape Drives**

Enter the number of virtual tape drives in the partition.

**i Note:** If all tape drives are currently assigned to other partitions, you must remove one or more tape drives from an existing partition to make them available for use in a new partition.

- 
4. (Optional) Under **Replication Settings**, specify replication settings.

For more information about configuring replication for a partition, or to set up replication for the partition at a later time, see [Replication on page 138](#).

5. Click **Apply**.
6. Click **Online** to return the partition to an online state.

## Deleting a VTL Partition

Delete a VTL partition if it is no longer needed. When you delete a partition, all data stored on the partition is lost.

---

**i Note:** If you delete a partition configured for Cartridge Based Replication on the source DXi, the partition is *not* automatically deleted on the target DXi. If you do not want to retain the partition on the target DXi, you can manually delete it.

To delete a VTL partition:

1. If the partition is online, select the partition and click **Offline** to take the partition offline. To delete a partition, it must be offline.
2. If there are tape cartridges in any of the tape drives in the partition, move the cartridges to storage slots (see [Media Move on page 245](#)). To delete a partition, all drives must be empty.
3. Select the partition and click **Delete**.

---

**i Note:** You can select multiple partitions to delete at once.

4. Click **Yes** to confirm the deletion.

If the partition contains tape cartridges, they are exported from the partition before it is deleted.

## Changing Partition Mode

Change the mode of a VTL partition to take it online or offline. To make backups to a partition, it must be online. To edit or delete a partition, it must be offline.

- To change the partition mode to online, select the partition and click **Online**.
- To change the partition mode to offline, select the partition and click **Offline**.

---

**i Note:** Taking a partition offline might disrupt backup operations.

# Media

The **Media** page allows you to manage virtual tape cartridges in VTL partitions on the DXi6900. Backup applications can write data to virtual tape cartridges just as they would to physical media.

To access the **Media** page, on the **VTL** page, click the **Media** tab.

The **Media** page contains the following tabs:

## Media Add

Use the **Media Add** page to add a contiguous range of virtual tape cartridges to a VTL partition. You can specify the initial location, starting barcode, media type, and media capacity. After the cartridges are created, they are available for backing up data.



**i Note:** It is possible to oversubscribe space on the DXi6900. In this case, the total capacity of all media is more than the capacity of the DXi. For guidance on selecting media quantity and size, see [Virtual Media—How Many and What Size? on page 23](#).

To access the **Media Add** page, on the **Media** page, click the **Add** tab (see [Figure 150 below](#)).

**Figure 150:** Media Add Page

The screenshot shows the 'Add Media' configuration page. At the top, there is a 'Help' button. The main configuration area is divided into two sections. The first section displays the current partition 'VTLtest7' and its associated models: Quantum DXi4700 for the Virtual Library Model and Quantum DLT-S4 for the Virtual Tape Drive Model. It also shows 'Empty Storage Slots' as 0 and 'Empty I/E Slots' as 2. A note indicates 'Existing Media' as 2 and 'All Storage Slots are occupied.' The second section, titled 'Add Contiguous Media', contains several input fields: 'Initial Location' set to 'I/E Slot', '\* Number of Media' (1 to 2), '\* Starting Barcode' (A-Z, 0-9), 'Media Type' set to 'DLT S4', and 'Media Capacity' with 'Native Size' (DLT S4, 800 GB) selected and 'Custom Size' (5 to 800 GB) as an alternative. A '\* Required Field' note is present. At the bottom, there are 'Apply' and 'Reset' buttons.

To add virtual tape cartridges to a partition:

1. In the **Partition** drop-down box, select the partition where the media will be created.
2. Under **Add Contiguous Media**, enter information about the media:

<b>Initial Location</b>	The initial location for cartridges after they are created ( <b>Storage Slot</b> or <b>I/E Slot</b> ).  <b>i Note:</b> You cannot create more cartridges than the number of available slots in the initial location. For example, if 50 I/E slots are available, you cannot create more than 50 cartridges if the initial location is set to <b>I/E Slot</b> .
<b>Number of Media</b>	The number of cartridges to create in the partition.
<b>Starting Barcode</b>	The first barcode number in the cartridge sequence.  You can enter any alpha-numeric string for the starting barcode (uppercase letters only). Subsequent barcodes are incremented accordingly. For example, if you enter AA, the cartridges are numbered AA0000, AA0001, AA0002, and so on. If you enter a starting barcode with less than 6 characters, zeroes are appended to the barcode to make it 6 characters long.
<b>Media Type</b>	The media type of the cartridges.  <b>i Note:</b> The available media type options are determined by the type of tape drive selected when the partition was created (see <a href="#">Adding a VTL Partition on page 233</a> ).
<b>Media Capacity</b>	The capacity of the cartridges. Select an option: <ul style="list-style-type: none"><li>• <b>Native Size</b> - The capacity is determined by the selected media type.</li><li>• <b>Custom Size</b> - The capacity is a custom value. Enter the custom cartridge capacity in the box. Make sure the value is within the acceptable range displayed next to the box</li></ul>

3. Click **Apply**.

## Media Actions

Use the **Media Actions** page to perform actions on virtual tape cartridges. You can import, export, and remove cartridges from VTL partitions. You can also configure cartridges to be write protected to prevent access.

To access the **Media Actions** page, on the **Media** page, click the **Actions** tab (see [Figure 151 on the next page](#)).

Figure 151: Media Actions Page

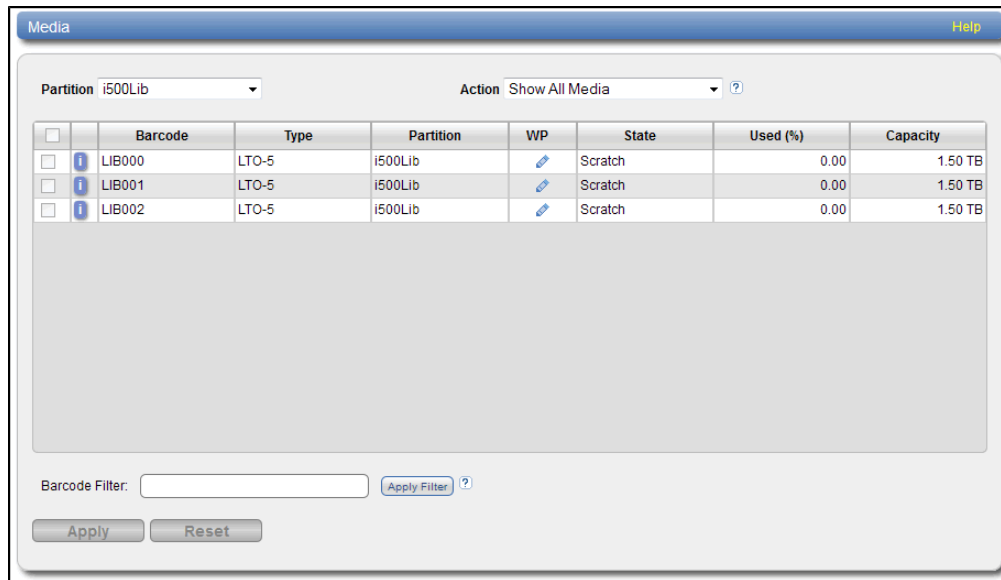

To perform actions on virtual tape cartridges:

1. In the **Partition** drop-down box, select the partition that contains the cartridges to work with.

**Note:** Select **UNASSIGNED** to work with cartridges that are not assigned to any partition.

The table displays the following information for all virtual tape cartridges in the partition:

<b>Barcode</b>	The barcode number of the cartridge.
<b>Type</b>	The cartridge type ( <b>LTO</b> or <b>SDLT</b> ).
<b>Partition</b>	The partition where the cartridge is located.
<b>WP</b>	The write protect status of the cartridge ( <b>Write Enabled</b> or <b>Write Protected</b> ).

---

<b>State</b>	The state of the cartridge: <b>State:</b> <ul style="list-style-type: none"><li>• <b>Scratch</b> - Scratch newly created virtual media or virtual media that has been recycled with no data on it.</li><li>• <b>Virtual</b> - Virtual media with data on it.</li><li>• <b>Virtual, Mounted</b> - Virtual media with data that is mounted in a tape drive.</li><li>• <b>Vaulted</b> - Virtual media with data that has been exported from a partition. Data is still intact on the virtual media.</li><li>• <b>Exported</b> - Virtual media with no data that has been exported from a partition. Media has to be in this state before it can be deleted from the DXi6900.</li><li>• <b>Pool</b> - The type of cartridge pool such as application, cleaning, service, or unknown.</li></ul>
<b>Used (%)</b>	The percentage of the tape cartridge that is used.   <b>Caution:</b> The <b>Used (%)</b> value is not updated while the media is mounted. Because of this, the displayed <b>Used (%)</b> value may be different from the real value for mounted media.
<b>Capacity</b>	The total capacity of the tape cartridge.

---

#### Additional Information

- Click a column heading to sort the rows in the table by that column.
- Click the column heading again to reverse the sort order. Click the Information button **[i]** next to a cartridge to display detailed information about the cartridge.

2. In the **Action** drop-down box, select the action to perform:

---

<b>Delete</b>	Deletes a cartridge from the *UNASSIGNED partition. The cartridge must be in the exported state.
<b>Export</b>	Removes a cartridge from the virtual media changer and places it in an exported state. Perform this action if an export cannot be performed from the backup application. The cartridge must be in the vaulted, scratch, or virtual state.
<b>Recycle</b>	Recycles (erases) a cartridge so it can be reused by the partition.
<b>Write Protect (WP)</b>	Enables or disables write protection for the cartridge.

---

---

**Import Media**

Imports cartridges into the currently selected partition. Cartridges that are in the exported or vaulted state can be imported from another partition with the same media type and data deduplication settings.

---

After you select an action, the table is updated to show only the cartridges that support the selected action. Select **Show All Media** in the **Action** drop-down box to see all cartridges.

3. (Optional) To reduce the number of cartridges displayed in the table, enter a barcode or barcode range in the **Barcode Filter** box and click **Apply Filter**.

Use a hyphen (-) to indicate a range, and use an asterisk (\*) to indicate a wildcard. Separate multiple entries with commas, and do not use spaces.

**Example:** Enter **AAA\*** to display all cartridge barcodes beginning with AAA. Or enter **AAA010-AAA020** to display all barcodes in the specified range. Click the **Quick Tip** icon [?] for additional examples.

4. Select the cartridges to perform the action on. The action is performed only for selected cartridges on the current page. Or select the check box in the table heading row to perform the action on all cartridges in the partition.

If necessary, use the controls at the bottom of the table to navigate between multiple pages of results. Select the number of rows to display in the **Show** drop-down box.

5. Click **Apply**.

## Media Move

Use the **Media Move** page to move a virtual tape cartridge from a source location (drive, storage slot, or I/E slot) to a destination location (drive, storage slot, or I/E slot). The location and destination must be in the same partition.

---

**Note:** If you do not create and associate a host access group with a partition, the virtual devices are not visible from the host, and drives cannot be destinations for move operations (see [Remote Host Access on page 248](#)).

---

**Caution:** Moving a virtual tape cartridge might disrupt backup jobs.

To access the **Media Move** page, on the **Media** page, click the **Move** tab (see [Figure 152 on the next page](#)).

Figure 152: Media Move Page

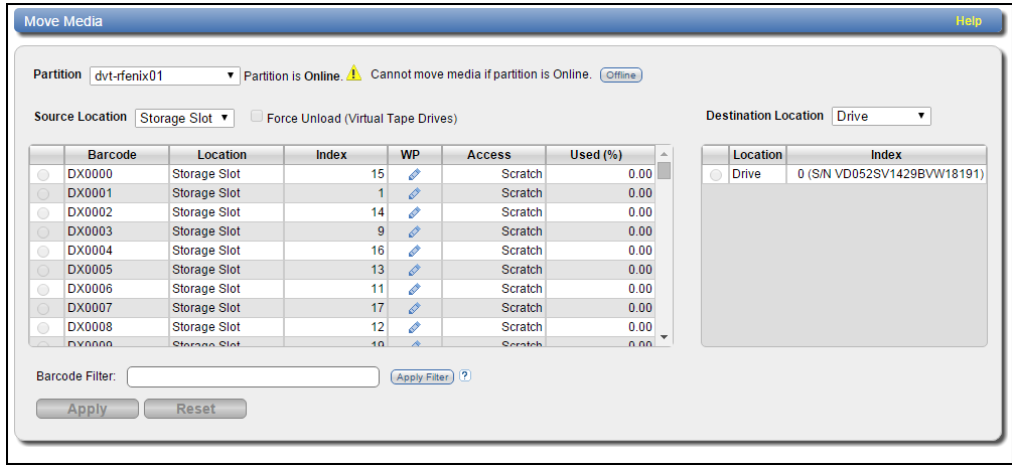

To move a virtual tape cartridge:

1. In the **Partition** drop-down box, select the partition that contains the cartridge to move.
2. If the partition is online, click **Offline** to take the partition offline. To move media, the partition must be offline.
3. In the **Source Location** drop-down box, select the type of location you want to move a cartridge from (**Drive, Storage Slot, I/E Slot**).
4. (Optional) If you are moving a cartridge from a drive, select the **Force Unload (Virtual Tape Drives)** check box to force the drive to unload the cartridge before ejecting it.
5. (Optional) To reduce the number of cartridges displayed in the table, enter a barcode or barcode range in the **Barcode Filter** box and click **Apply Filter**.

Use a hyphen (-) to indicate a range, and use an asterisk (\*) to indicate a wildcard. Separate multiple entries with commas, and do not use spaces.

**Example:** Enter **AAA\*** to display all cartridge barcodes beginning with AAA. Or enter **AAA010-AAA020** to display all barcodes in the specified range. Click the **Quick Tip** icon [?] for additional examples.

6. Select the cartridge to move from the source location.

**Note:** If necessary, use the controls at the bottom of the table to navigate between multiple pages of results. Select the number of rows to display in the **Show** drop-down box.

7. In the **Destination Location** drop-down box, select the type of location you want to move the cartridge to (**Drive, Storage Slot, I/E Slot**).
8. Select the destination location to move the cartridge to.

**Note:** The destination section displays empty drives, storage slots, and I/E slots. Offline drives are *not* displayed. A drive might be offline if it has not been mapped to a host (see [Remote Host Access on the next page](#)).

9. Click **Apply**.
10. Return the partition to an online state (see [Changing Partition Mode on page 240](#)).

## Media Unload

Use the **Media Unload** page to perform a bulk unload of virtual tape cartridges from drives or I/E slots.

**Note:** If you do not create and associate a host access group with a partition, the virtual devices are not visible from the host, and drives cannot be destinations for move operations (see [Remote Host Access on the next page](#)).

**Caution:** If you unload a virtual tape cartridge from a drive while a backup to that drive is in progress, the backup job will fail.

To access the **Media Unload** page, on the **Media** page, click the **Unload** tab (see [Figure 153 below](#)).

**Figure 153:** Media Unload Page

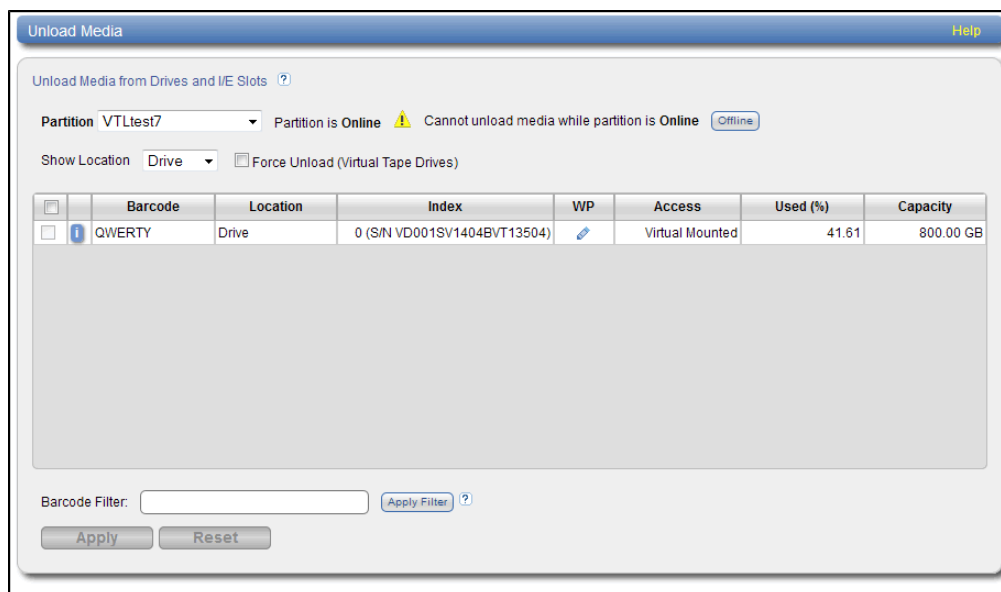

To unload virtual tape cartridges:

1. In the **Partition** drop-down box, select the partition that contains the cartridges to unload.
2. If the partition is online, click **Offline** to take the partition offline. To unload media, the partition must be offline.
3. In the **Show Location** drop-down box, select the type of location you want to unload cartridges from (**Drive**, **I/E Slot**).

- (Optional) If you are unloading cartridges from a drive, select the **Force Unload (Virtual Tape Drives)** check box to force drives to unload the cartridges before ejecting them.
- (Optional) To reduce the number of cartridges displayed in the table, enter a barcode or barcode range in the **Barcode Filter** box and click **Apply Filter**.

Use a hyphen (-) to indicate a range, and use an asterisk (\*) to indicate a wildcard. Separate multiple entries with commas, and do not use spaces.

**Example:** Enter **AAA\*** to display all cartridge barcodes beginning with AAA. Or enter **AAA010-AAA020** to display all barcodes in the specified range. Click the **Quick Tip** icon [?] for additional examples.

- Select the cartridges to unload.

**Note:** If necessary, use the controls at the bottom of the table to navigate between multiple pages of results. Select the number of rows to display in the **Show** drop-down box.

- Click **Apply**.

Cartridges are moved to a previous storage slot if available. Otherwise, they are moved to the first available storage slot.

- Return the partition to an online state (see [Changing Partition Mode on page 240](#)).

## Remote Host Access

The **Remote Host Access** page allows you to configure virtual media changers and tape drives on the DXi6900 to communicate with Fibre Channel hosts (initiators). You can add, edit, and delete hosts as well as view Fibre Channel target ports on the DXi.

If you do not create and associate a host access group with a partition, the virtual devices are not visible from the host, and drives cannot be destinations for move operations.

### Fibre Channel Host Bus Adapters (HBAs) - Data Payload Size

The Fibre Channel HBAs used on the DXi6900 have a maximum data payload size per frame of 2048 bytes. The Fibre Channel specification allows a maximum data payload size of 2112 bytes per frame. Fibre Channel HBAs used on backup hosts should be configured to use a maximum data payload size of 2048 bytes per frame. Failure to match the backup host maximum data payload size to the DXi6900 maximum data payload size may result in stalled data transfers.

To access the **Remote Host Access** page, on the **VTL** page, click the **Remote Host Access** tab.

The **Remote Host Access** page contains the following tabs:



## Remote Host Mapping

The **Remote Host Mapping** page allows you to view information about existing host access groups. You can also add or edit groups, and delete groups.

Host access groups allow backup hosts to access virtual devices on a DXi6900. A host access group is associated with a partition, a host (a Fibre Channel initiator on the SAN), and a target (a Fibre Channel port on the DXi6900). This association allows the host to access one or more devices in the partition using different host LUNs on the port. To allow multiple hosts to access devices that belong to the same partition, you must create separate host access groups for each host.

To access the **Remote Host Mapping** page, on the **Remote Host Access** page, click the **Remote Host Mapping** tab (see [Figure 154 below](#)).

**Figure 154:** Remote Host Mapping Page

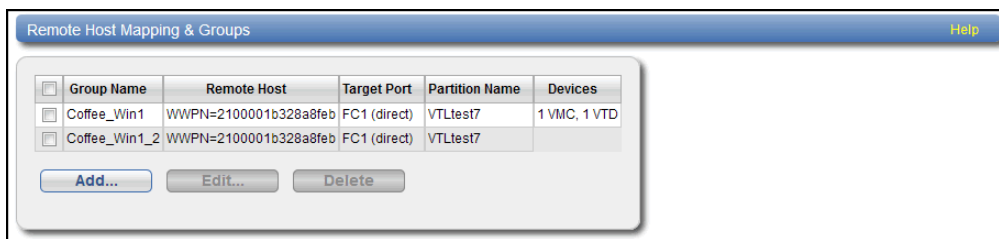

### Tasks

Use the **Remote Host Mapping** page to perform the following tasks:

- View information about existing host access groups (see [Remote Host Mapping And Groups below](#)).
- Add a new host access group to a partition (see [Adding a Remote Host Access Group on the next page](#)).
- Edit properties for an existing host access group (see [Editing a Remote Host Access Group on page 251](#)).
- Delete a host access group from a partition (see [Deleting a Remote Host Access Group on page 252](#)).

### Remote Host Mapping And Groups

The **Remote Host Mapping And Groups** section displays the following information for all host access groups on the DXi6900:

<b>Group Name</b>	The name of the group.
<b>Remote Host</b>	The host (initiator) associated with the group.

<b>Target Port</b>	The Fibre Channel port (target) associated with the group.
<b>Partition Name</b>	The VTL partition associated with the group.
<b>Devices</b>	The number of virtual media changers (VMCs) and virtual tape drives (VTDs) associated with the group

**i Note:** Click a column heading to sort the rows in the table by that column. Click the column heading again to reverse the sort order.

### Adding a Remote Host Access Group

Add a host access group to associate a VTL partition with a host (a Fibre Channel initiator on the SAN) and a target (a Fibre Channel port on the DXi6900).

To add a host access group:

1. Click **Add**.

The **Map Remote Hosts, Define Groups** page displays (see [Figure 155 below](#)).

**Figure 155:** Map Remote Hosts, Define Groups Page

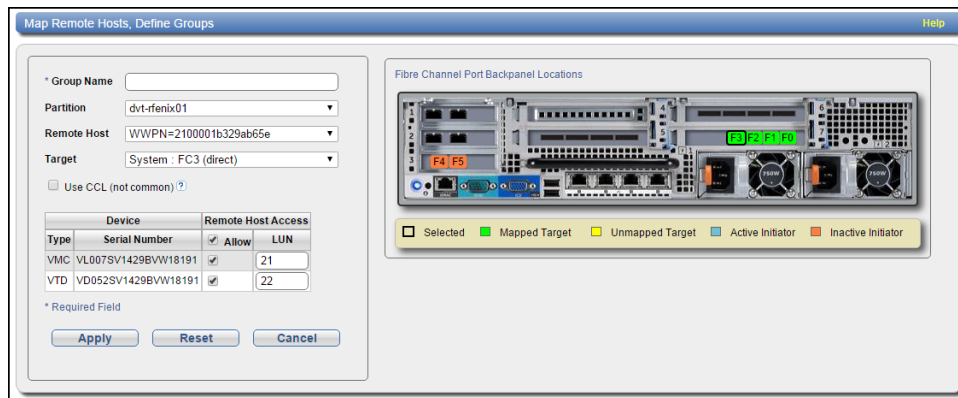

2. Enter information about the host access group:

<b>Group Name</b>	Enter a name for the group.
<b>Partition</b>	Select the partition to associate with the group.
<b>Remote Host</b>	Select the host (initiator) to associate with the group. <b>i Note:</b> You must configure a host before it is available in the <b>Host</b> drop-down box (see <a href="#">Remote Hosts on page 253</a> ).

---

**Target**

Select the target (port) to associate with the group.

The **Backpanel Locations** section displays a graphical representation of the Fibre Channel and Ethernet ports as they appear on the rear of the system. A dark border displays around the currently selected target.

 **Note:** If a target is directly connected to the DXi, only the directly connected ports are displayed. Otherwise, all ports are displayed.

---

3. (Optional) Select the **Use CCL** check box to use the Command and Control LUN.

 **Note:** The CCL (Command and Control LUN) is not used in most environments. This option is recommended for host access groups that contain an HP-UX host. It can also be used if hosts that are not assigned to any host access group exist in the SAN. The CCL is accessible to hosts only through LUN 0.

 **Caution:** If you are not sure if you should use CCL, contact Quantum Customer Support before you enable this option.

4. Select the check boxes for the media changer and tape drives to add to the host access group.  
The LUN assignment displays next to the device.
5. Click **Apply**.

### Editing a Remote Host Access Group

Edit a host access group to change the CCL setting. You can also add or remove virtual media changers or tape drives.

To edit a host access group:

1. Select the group and click **Edit**.

The **Edit Remote Host Mapping** page displays (see [Figure 156 on the next page](#)).

 **Note:** If you are editing a host access group, you cannot change the **Group Name**, **Partition**, **Host**, or **Target**.

Figure 156: Edit Remote Host Mapping Page



- (Optional) Select the **Use CCL** check box to use the Command and Control LUN.

**Note:** The CCL (Command and Control LUN) is not used in most environments. This option is recommended for host access groups that contain an HP-UX host. It can also be used if hosts that are not assigned to any host access group exist in the SAN. The CCL is accessible to hosts only through LUN 0.

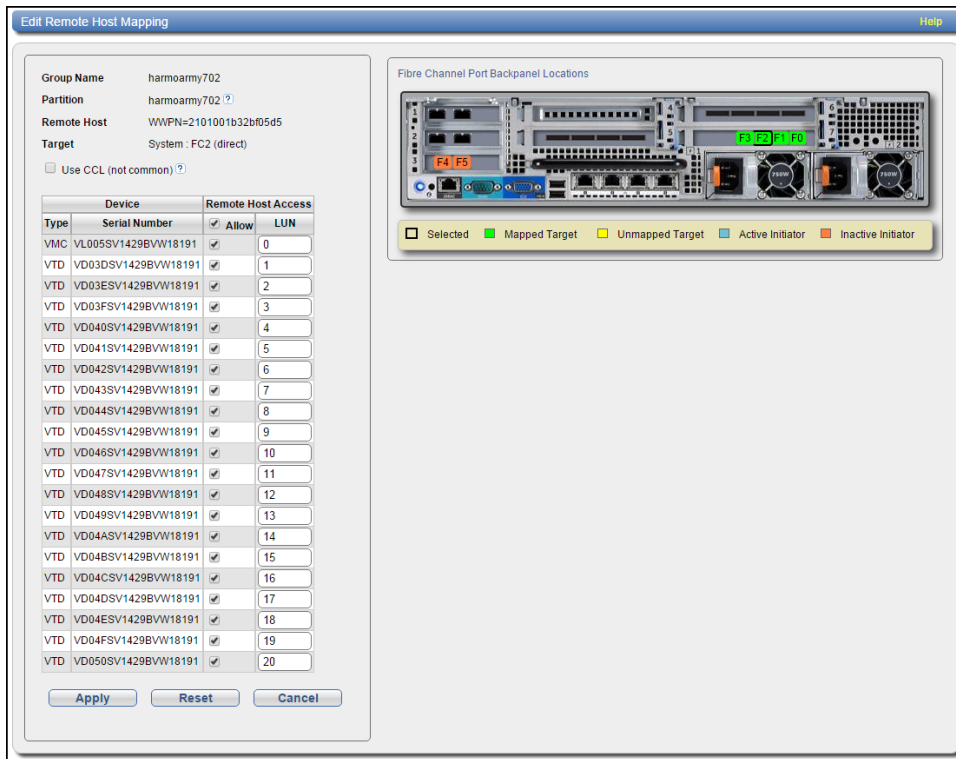
**Caution:** If you are not sure if you should use CCL, contact Quantum Customer Support before you enable this option.

- Select the check boxes for the media changer and tape drives to add to the host access group. The LUN assignment displays next to the device.
- Click **Apply**.

### Deleting a Remote Host Access Group

Delete a host access group if it is no longer needed.

To delete a host access group:

1. Select the group and click **Delete**.

**Note:** You can select multiple groups to delete at once.

2. Click **Yes** to confirm the deletion.

## Remote Hosts

Use the **Remote Hosts** page to discover and add Fibre Channel hosts to the available host list for the DXi6900.

**Note:** You must configure a host before you can assign it to a new host access group (see [Adding a Remote Host Access Group on page 250](#)).

**Caution:** If you are connecting the DXi6900 directly to a host without using a Fibre Channel switch, you must know the WWPN connecting to each DXi6900 port. If you do not specify this information, the virtual medium changer and tape drives will not display on the device manager.

To access the **Remote Hosts** page, on the **Remote Host Access** page, click the **Remote Hosts** tab (see [Figure 157 below](#) and [Figure 158 below](#)).

Figure 157: Remote Hosts Page

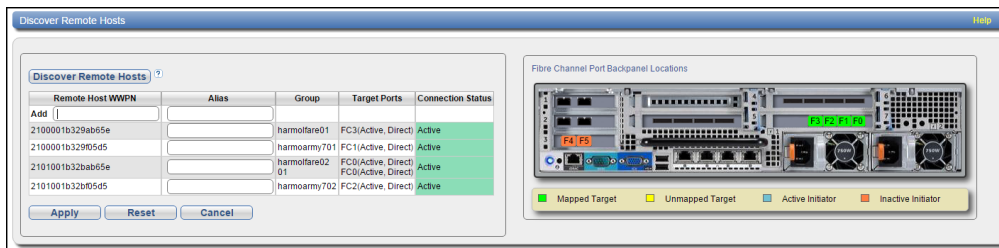
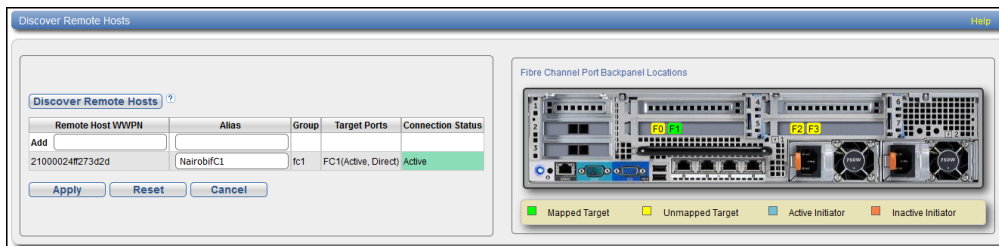

Figure 158: DXi6900 G2 / DXi6900-S Remote Hosts Page



To add a host:

1. Click **Discover Remote Hosts** to list all hosts that are known to the DXi6900.

A host is made known to the DXi6900 if you enter the host ID on this page, or if the host logs on to one or more Fibre Channel target ports.

If you do not see the world wide name (WWN) of the host, make sure the host is connected to a Fibre Channel port on the DXi6900 and click **Discover Hosts** again.

The **Backpanel Locations** section displays a graphical representation of the Fibre Channel and Ethernet ports as they appear on the rear of the system.

**i Note:** A mapped (green) status indicates the host is currently logged on to one or more Fibre Channel target ports.

2. Enter information about the host:

<b>Remote Host WWPN</b>	Enter the World Wide Port Name (WWPN) of the host. (This value is entered automatically by the system.)
<b>Alias</b>	(Optional) Enter a descriptive alias for the host.

3. Click **Apply**.

**i Note:** To delete a host that is no longer needed, click **Delete** next to the host. You cannot delete a host of it is currently assigned to a host access group

## Targets

Use the **Targets** page to view the current target (Fibre Channel) configuration.

To access the **Targets** page, on the **Host Access** page, click the **Targets** tab (see [Figure 159 below](#) and [Figure 160 on the next page](#)).

**Figure 159:** DXi6900 G1 Targets Page

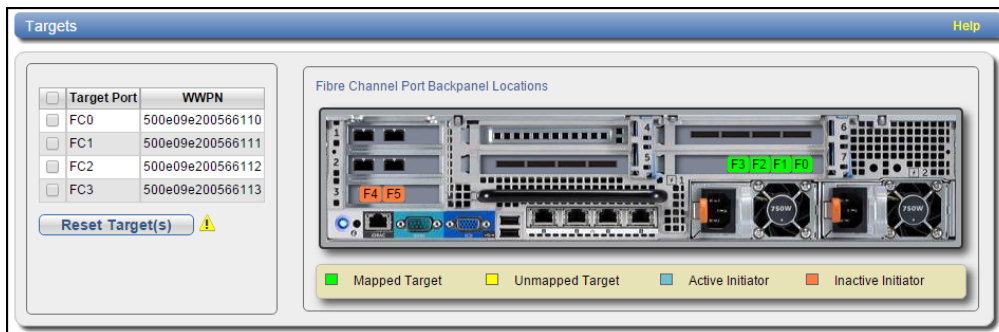
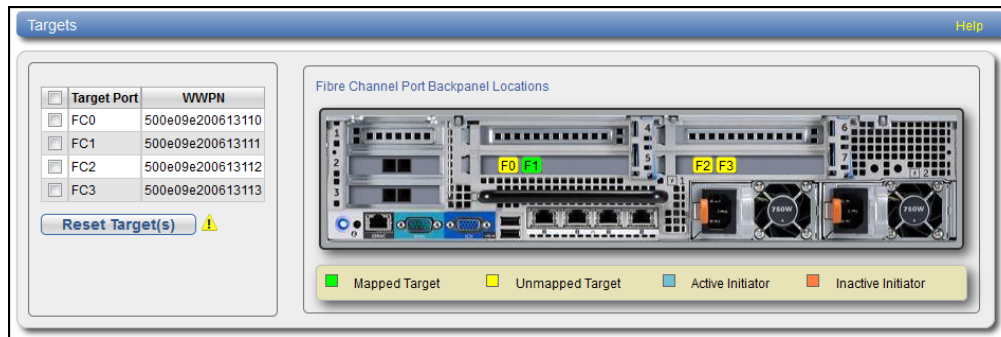

Figure 160: DXi6900 G2/DXi6900-S Targets Page



The **Targets** page displays the **Target Port** and **WWPN** for the currently configured targets. The **Backpanel Locations** section displays a graphical representation of the Fibre Channel and Ethernet ports as they appear on the rear of the system.

**Note:** A mapped (green) status indicates the host is currently logged on to one or more Fibre Channel target ports.

Select one or more targets and click **Reset Target(s)** to initiate a Fibre Channel reset on the selected ports. A reset causes the ports to go through LIP (Loop Initialization Protocol).

## Target Usage

Use the **Target Usage** page to view current target and device mappings for the DXi6900.

To access the **Target Usage** page, on the **Host Access** page, click the **Target Usage** tab (see [Figure 161 on the next page](#) and [Figure 162 on page 257](#)).

Figure 161: DXi6900 G1 Target Usage Page

Target Usage
Help

Fibre Channel Port Backpanel Locations



■ Mapped Target
■ Unmapped Target
■ Active Initiator
■ Inactive Initiator

**Target Port FC0**

Partition harmolfare02

Device	Serial Number
VMC	VL002SV1429BWW18191
VTD	VD015SV1429BWW18191
VTD	VD016SV1429BWW18191
VTD	VD017SV1429BWW18191
VTD	VD018SV1429BWW18191
VTD	VD019SV1429BWW18191
VTD	VD01ASV1429BWW18191
VTD	VD01BSV1429BWW18191
VTD	VD01CSV1429BWW18191
VTD	VD01DSV1429BWW18191
VTD	VD01ESV1429BWW18191
VTD	VD01FSV1429BWW18191
VTD	VD020SV1429BWW18191
VTD	VD021SV1429BWW18191
VTD	VD022SV1429BWW18191
VTD	VD023SV1429BWW18191
VTD	VD024SV1429BWW18191

Partition harmolfare03

Device	Serial Number
VMC	VL003SV1429BWW18191
VTD	VD029SV1429BWW18191
VTD	VD02ASV1429BWW18191
VTD	VD02BSV1429BWW18191
VTD	VD02CSV1429BWW18191

**Target Port FC1**

Partition harmoarmy701

Device	Serial Number
VMC	VL004SV1429BWW18191
VTD	VD025SV1429BWW18191
VTD	VD026SV1429BWW18191
VTD	VD027SV1429BWW18191
VTD	VD028SV1429BWW18191
VTD	VD02DSV1429BWW18191
VTD	VD02ESV1429BWW18191
VTD	VD02FSV1429BWW18191
VTD	VD030SV1429BWW18191
VTD	VD031SV1429BWW18191
VTD	VD032SV1429BWW18191
VTD	VD033SV1429BWW18191
VTD	VD034SV1429BWW18191
VTD	VD035SV1429BWW18191
VTD	VD036SV1429BWW18191
VTD	VD037SV1429BWW18191
VTD	VD038SV1429BWW18191
VTD	VD039SV1429BWW18191
VTD	VD03ASV1429BWW18191
VTD	VD03BSV1429BWW18191
VTD	VD03CSV1429BWW18191

**Target Port FC2**

Partition harmoarmy702

Device	Serial Number
VMC	VL005SV1429BWW18191
VTD	VD03DSV1429BWW18191
VTD	VD03ESV1429BWW18191
VTD	VD03FSV1429BWW18191
VTD	VD040SV1429BWW18191
VTD	VD041SV1429BWW18191
VTD	VD042SV1429BWW18191
VTD	VD043SV1429BWW18191
VTD	VD044SV1429BWW18191
VTD	VD045SV1429BWW18191
VTD	VD046SV1429BWW18191
VTD	VD047SV1429BWW18191
VTD	VD048SV1429BWW18191
VTD	VD049SV1429BWW18191
VTD	VD04ASV1429BWW18191
VTD	VD04BSV1429BWW18191
VTD	VD04CSV1429BWW18191
VTD	VD04DSV1429BWW18191
VTD	VD04ESV1429BWW18191
VTD	VD04FSV1429BWW18191
VTD	VD050SV1429BWW18191

**Target Port FC3**

Partition harmolfare01

Device	Serial Number
VMC	VL001SV1429BWW18191
VTD	VD001SV1429BWW18191
VTD	VD002SV1429BWW18191
VTD	VD003SV1429BWW18191
VTD	VD004SV1429BWW18191
VTD	VD005SV1429BWW18191
VTD	VD006SV1429BWW18191
VTD	VD007SV1429BWW18191
VTD	VD008SV1429BWW18191
VTD	VD009SV1429BWW18191
VTD	VD00ASV1429BWW18191
VTD	VD00BSV1429BWW18191
VTD	VD00CSV1429BWW18191
VTD	VD00DSV1429BWW18191
VTD	VD00ESV1429BWW18191
VTD	VD00FSV1429BWW18191
VTD	VD010SV1429BWW18191
VTD	VD011SV1429BWW18191
VTD	VD012SV1429BWW18191
VTD	VD013SV1429BWW18191
VTD	VD014SV1429BWW18191



Figure 162: DXi6900 G2/DXi6900-S Target Usage Page

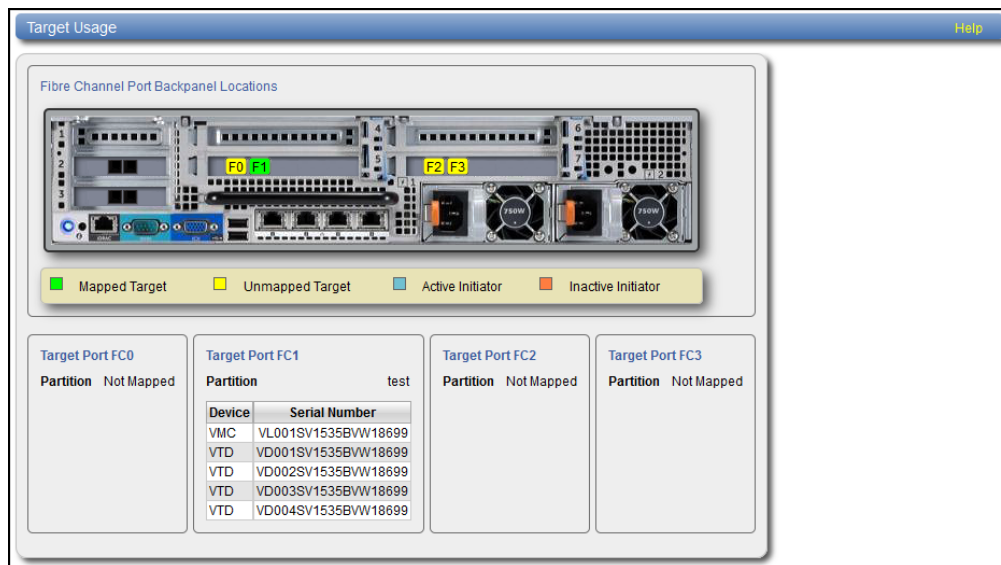

The **Backpanel Locations** section displays a graphical representation of the Fibre Channel and Ethernet ports as they appear on the rear of the system.

**Note:** A mapped (green) status indicates the host is currently logged on to one or more Fibre Channel target ports.

Each target Fibre Channel port is displayed, along with the partition and virtual media changer and tape drives (VMC and VTDs) mapped to the port.

## OST Configuration

The **OST** page allows you to configure the DXi6900 to present its storage capacity as storage servers using OpenStorage (OST) technology. You can add one or more Logical Storage Units (LSUs) to a storage server. Storage servers and LSUs are compatible with backup applications that support OST, such as Symantec NetBackup and Symantec Backup Exec. In addition, OST data can be duplicated (replicated) between DXi systems using NetBackup (see [Replicating OST Data on the next page](#)).

To authenticate OST devices on a media server, you must create OST user credentials. After you create the OST user credentials, enter them in the backup application to authenticate OST devices on the media server.

To access the **OST** page, click the **Configuration** menu, and then click the **OST** tab.

The **OST** page contains the following tabs:

- [Storage Servers on page 260](#)
- [LSU on page 266](#)

- [Manage Users \(DXi6900\) on page 272](#)
- [Manage Remote Users on page 275](#)
- [Target IP Mapping on page 278](#)
- [DXi Accent on page 281](#)
- [OST Client Plug-In \(DXi6900\) on page 282](#)

## Replicating OST Data

The DXi6900 can replicate (duplicate) OST data to another DXi using the following methods:

Replication Method	Description
<b>Optimized Duplication</b>	With optimized duplication, backup images on a storage server can be replicated to another storage server on a DXi that resides in the same NetBackup domain. The duplication occurs when it is initiated in NetBackup. With optimized duplication can specify up to two replication targets
<b>Automatic Image Replication (AIR)</b>	If you are using Symantec NetBackup 7.1 or higher, you can configure an LSU for Automatic Image Replication (see <a href="#">OST Configuration on the previous page</a> ). If enabled, data on an LSU is automatically replicated to a remote LSU that resides on a DXi in a different NetBackup domain. The timing of the duplication, as well as the backup images that are duplicated, are determined by the storage lifecycle policies (SLPs) configured in NetBackup. With AIR, you can specify a single replication target.
<b>Concurrent Optimized Duplication</b>	For both optimized duplication and Automatic Image Replication, you can optionally enable Concurrent Optimized Duplication. If enabled, as data is written to the storage server, it is simultaneously replicated to the target DXi. When optimized duplication or Automatic Image Replication subsequently occurs, the operation is more efficient because a portion of the required data has already been replicated to the target storage server.

It is important to remember that, with Automatic Image Replication, the local and remote LSUs reside in *different* NetBackup domains. This differs from optimized duplication, which occurs between two LSUs residing within *the same* NetBackup domain.

- i Note:** For more information about configuring the DXi6900 for optimized duplication or Automatic Image Replication, see the *DXi-Series NetBackup and Backup Exec OST Configuration Guide (6-67079)*.

---

**i Note:** For information about configuring NetBackup for optimized duplication or Automatic Image Replication (also referred to as duplicating images to a remote master server domain), see the *Symantec NetBackup Administrator's Guide*.

## Task Overview: Setting Up Automatic Image Replication

Setting up Automatic Image Replication (AIR) requires that you first configure the target (remote) DXi and then the source DXi (see [Figure 163 below](#)). In addition, you must create storage lifecycle policies (SLPs) in NetBackup that define when the automatic replication occurs and which backup images are duplicated.

To automatically replicate (duplicate) all data on an LSU to a remote LSU that resides on a DXi in a different NetBackup domain:

1. On the target system, add the source system to the list of allowed replication sources (see ).
2. On the target system, create a local OST user (see [Manage Users \(DXi6900-S\) on page 357](#))(see [Manage Users \(DXi6900\) on page 272](#)).

---

**⚠ Caution:** On the target system, make sure to create a *local* user on the **Configuration > OST > Manage Users** page.

3. On the target system, create a storage server and LSU to receive the replicated OST data (see [Adding a Storage Server on page 262](#)).

---

**i Note:** Quantum recommends selecting the **Available Capacity** option when creating an LSU for use with Automatic Image Replication.

4. On the source system, specify the target system that will receive the replicated data (see [Adding a Replication Target on page 284](#)).
5. On the source system, create a remote OST user with the same user name and password that you used in step 2 above (see [Manage Remote Users on page 275](#)).

---

**⚠ Caution:** On the source system, make sure to create a *remote* user on the **Configuration > OST > Manage Remote Users** page.

6. On the source system, create a storage server and LSU, and enable the LSU for Automatic Image Replication (see [Adding a Storage Server on page 262](#)).

For **Remote Storage Server** and **Remote LSU**, make sure to specify the storage server and LSU created in step 3 above. Also, for **Remote User**, make sure to select the remote user created in step 5 above.

7. Configure storage lifecycle policies in NetBackup to control when automatic replication of the LSU occurs (see the *Symantec NetBackup Administrator's Guide*).

**Figure 163:** Setting Up OST Automatic Image Replication

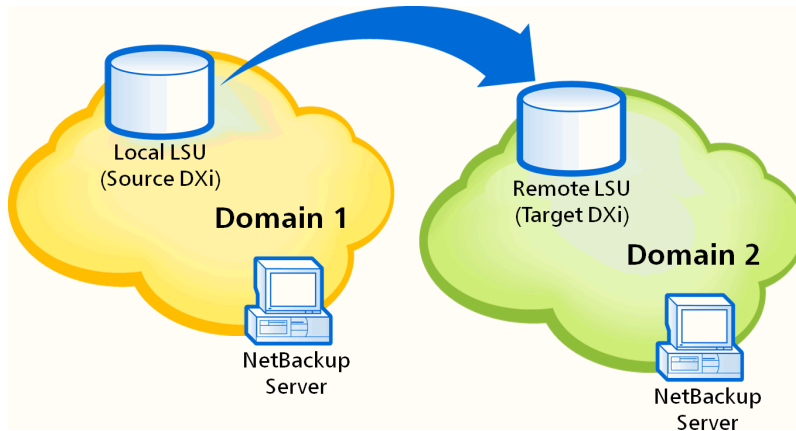

## Storage Servers

The **Storage Servers** page allows you to manage OST storage servers on the DXi6900. You can view information about existing storage servers, add or edit storage servers, and delete storage servers.

To access the **Storage Servers** page, on the **OST** page, click the **Storage Servers** tab (see [Figure 164 below](#)).

**Figure 164:** Storage Servers Page

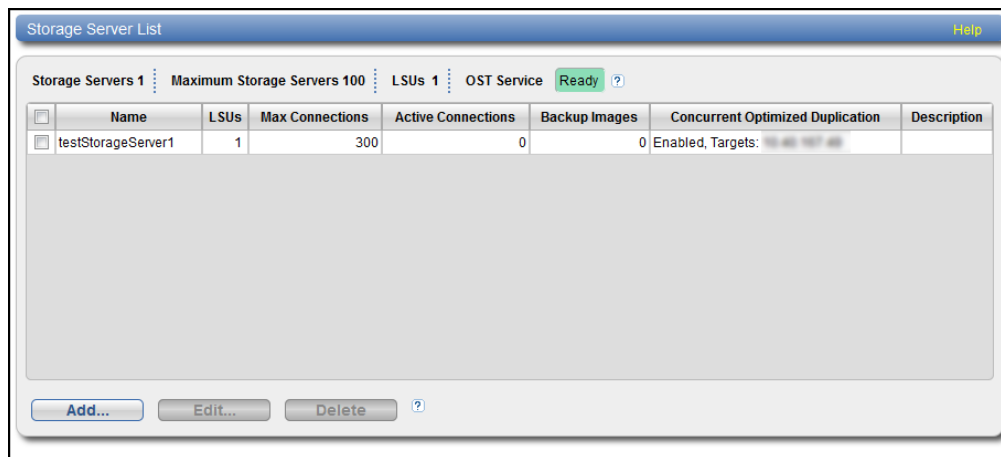

### Tasks

Use the **Storage Servers** page to perform the following tasks:

- View information about existing storage servers (see [Storage Server List on the next page](#)).
- Add a new storage server to the system (see [Adding a Storage Server on page 262](#)).

- Edit properties for an existing storage server (see [Editing a Storage Server on page 264](#)).
- Delete a storage server from the system (see [Deleting Storage Server](#)).

## Storage Server List

The **Storage Server List** displays the following information for all storage servers on the DXi6900:

<b>Storage Servers</b>	The number of storage servers that have been added to the system.
<b>Maximum Storage Servers</b>	The maximum number of storage servers that can be added to the system.
<b>LSUs</b>	The number of logical storage units (LSUs) that have been added to the system (see <a href="#">LSU on page 266</a> ).
<b>OST Service</b>	The status of the OST service. OST settings can be configured in <b>Ready</b> , <b>Stopped</b> , or <b>Verifying</b> state. The OST server is available for backup only in <b>Ready</b> state.
<b>Name</b>	The name of the storage server.
<b>LSUs</b>	The number of LSUs that have been added to the storage server.
<b>Max Connections</b>	The maximum number of connections allowed to the storage server.
<b>Active Connections</b>	The number of currently active connections to the storage server.
<b>Backup Images</b>	The number of backup images on the storage server.
<b>Concurrent Optimized Duplication</b>	The status of Concurrent Optimized Duplication for the storage server ( <b>Enabled</b> or <b>Disabled</b> ), as well as the configured targets (if any).
<b>Description</b>	A brief description of the storage server (if available).

### Additional Information

- Click a column heading to sort the rows in the table by that column. Click the column heading again to reverse the sort order.
- The connections of a storage server that are used equals the data streams plus one for each LSU polling. A backup job may generate more than one data stream if the data can be read in parallel. For example, a policy that is backing up A, B, C, and D drives of a Windows system can generate four data streams in parallel.

## Adding a Storage Server

Add a storage server to present the storage capacity of the DXi6900 as LSUs that are compatible with backup applications that support OST. You can add up to 100 storage servers. When adding a storage server, you must also add an LSU to the storage server. (For more information about LSUs, see [LSU on page 266](#).)

**Note:** Data on storage servers is always deduplicated.

To add a storage server:

1. Click **Add**.

The **Add Storage Server** page displays (see [below](#)).

Add Storage Server Page





The screenshot shows the 'Add Storage Server' configuration window. It contains the following elements:

- Add Storage Server ?** (Title)
- \* Name**: Text input field.
- Description**: Text input field.
- \* Max Connections**: Text input field with value '300' and range '(0 to 65536)'. A checkbox is present to its left.
- Enable Concurrent Optimized Duplication**: Checkable option.
- Table:**

Concurrent Optimized Duplication	Target DXIs	Status	Encryption
<input type="checkbox"/>	10.40.167.49	Ready	AES 256-bit
- Logical Storage Unit**: Section header.
- Available Capacity**: Selected radio button.
- Specific Capacity**: Unselected radio button.
- LSU Name**: Text input field.
- Physical Capacity**: Text input field with range '(1 to 1048576 GB)'. A checkbox is present to its left.
- Description**: Text input field.
- Enable Automatic Image Replication ?**: Checkable option.
- Replication Target DXIs**: Text input field with value '10.40.167.49' and a search icon.
- \* Remote Storage Server Name**: Text input field.
- \* Remote LSU Name**: Text input field with value '\_PhysicalLSU'.
- Remote User**: Dropdown menu with a help icon.
- \* Required Field**: Legend.
- Buttons**: 'Apply', 'Reset', and 'Cancel'.

2. Under **Add Storage Server**, enter information about the storage server:

---

<b>Name</b>	<p>Enter the name of the storage server.</p> <p> <b>Caution:</b> Do not use an underscore ( _ ) in the name of the storage server.</p> <p> <b>Note:</b> OST storage server names are not case-sensitive. For example, if you create a storage server named <b>ost1</b>, you cannot create another storage server named <b>OST1</b> because the system considers the names to be the same.</p>
<b>Description</b>	<p>(Optional) Enter a brief description of the storage server.</p>
<b>Max Connections</b>	<p>Enter the maximum number of connections allowed to the storage server (3 to 65536)</p> <p>Quantum recommends setting <b>Max Connections</b> to 300.</p>
<b>Enable Concurrent Optimized Duplication</b>	<p>Select the check box to enable optimized duplication during OST ingest.</p> <p>Concurrent Optimized Duplication is disabled by default. If enabled, as data is written to the storage server, it is simultaneously replicated to the target DXi. When optimized duplication or Automatic Image Replication subsequently occurs, the operation is more efficient because a portion of the required data has already been replicated to the target storage server.</p> <p> <b>Note:</b> To configure the target DXi, see <a href="#">Adding a Replication Target on page 284</a>.</p> <p> <b>Note:</b> When Concurrent Optimized Duplication is enabled, all data on the storage server is duplicated, not just the specified images.</p>

---

3. Select the check box for each optimized duplication target you want to duplicate the storage server to. When the storage server is duplicated, its data will be sent to all selected targets.
4. Under **Logical Storage Unit**, select the type of LSU to add to the new storage server:

---

<b>Available Capacity</b>	<p>(Recommended for best performance) Select this option to add an LSU that uses the available capacity on the system.</p> <p>You cannot add an available capacity LSU to a storage server that already contains an LSU. Also, if you add an available capacity LSU to a storage server, you cannot add additional LSUs to that same storage server.</p> <p> <b>Note:</b> After you add an LSU that uses the <b>Available Capacity</b> option, you cannot change the LSU to use the <b>Specific Capacity</b> option. Instead, you must delete the LSU, then add a new LSU and choose the <b>Specific Capacity</b> option (see <a href="#">Deleting an LSU on page 272</a>).</p>
---------------------------	--

---

---

**Specific Capacity**

Select this option to specify the physical capacity of the LSU, and then enter the following information.

- **LSU Name** - Enter the name of the LSU.
- **Physical Capacity** - Enter the physical capacity of the LSU (1 to 1048576 GB).

**i Note:** Quantum recommends setting LSUs to maximum size (1048576 GB) because spanning them on a backup is not possible.

---

5. (Optional) In the **Description** box, enter a brief description of the LSU.
6. (Optional) Select the **Enable Automatic Image Replication** check box to automatically replicate (duplicate) data on the LSU to a remote LSU on another DXi.

Automatic Image Replication (AIR) is disabled by default. If enabled, data on an LSU is automatically replicated to a remote LSU that resides on a DXi in a different NetBackup domain. The timing of the duplication, as well as the backup images that are duplicated, are determined by the storage lifecycle policies (SLPs) configured in NetBackup.

OST AIR requires NetBackup 7.1 or higher. For information about configuring NetBackup for Automatic Image Replication, see the *DXi-Series NetBackup and Backup Exec OST Configuration Guide* (6-67079).

---

**i Note:** You must configure at least one remote user before you can enable Automatic Image Replication (see [Manage Remote Users on page 275](#)).

7. If Automatic Image Replication is enabled, select the replication target you want to replicate images to. (You can select only a single target.) When images are replicated, data will be sent to the selected target.
8. If Automatic Image Replication is enabled, specify the following information:

---

**Remote Storage Server Name**

The name of the remote storage server (on the target DXi) to replicate data to. The source DXi and target DXi must reside in different NetBackup domains.

**i Note:** To configure the target DXi, see [Replication Send on page 145](#).

---

**Remote LSU Name**

The name of the LSU in the remote storage server that will receive the replicated data.

---

**Remote User**

The OST user credentials to use for authentication on the remote (target) DXi. The selected remote user *must* match a local user on the **Configuration > OST > Manage Users** page on the target DXi (see [Manage Users \(DXi6900-S\) on page 357](#))(see [Manage Users \(DXi6900\) on page 272](#)).

---

9. Click **Apply**.

## Editing a Storage Server

Edit a storage server to change the description of the storage server or the maximum number of allowed



connections.

To edit a storage server:

1. Select the storage server and click **Edit**.

The **Edit Storage Server** page displays (see [Figure 165 below](#)).

**Figure 165:** Edit Storage Server Page

Concurrent Optimized Duplication	Target DXis	Status	Encryption
<input checked="" type="checkbox"/>		Ready	AES 256-bit

2. Enter information about the storage server:

**Note:** If you are editing a storage server, the **Name** option cannot be changed.

<b>Description</b>	(Optional) Enter a brief description of the storage server.
<b>Max Connections</b>	Enter the maximum number of connections allowed to the storage server (3 to 65536).  The maximum number of connections cannot be changed if the storage server has more than zero currently active connections. The number of active connections is displayed on the <b>OST</b> page (see <a href="#">Storage Server List on page 261</a> ).

**Note:** Quantum recommends setting **Max Connections** to 300.

---

### Enable Concurrent Optimized Duplication

Select the check box to enable optimized duplication during OST ingest.

Concurrent Optimized Duplication is disabled by default. If enabled, as data is written to the storage server, it is simultaneously replicated to the target DXi. When optimized duplication or Automatic Image Replication subsequently occurs, the operation is more efficient because a portion of the required data has already been replicated to the target storage server.

#### Additional Information

- To configure the target DXi, see [Replication Send on page 145](#).
- When Concurrent Optimized Duplication is enabled, all data on the storage server is duplicated, not just the specified images.

- 
3. Select the check box for each optimized duplication target you want to duplicate the storage server to. When the storage server is duplicated, its data will be sent to all selected targets.
  4. Click **Apply**.

## Deleting a Storage Server

Delete a storage server if it is no longer needed. When you delete a storage server, all data stored on the storage server is lost.

---

**i Note:** If you deleted the storage server from Symantec NetBackup or Symantec Backup Exec, you must wait several minutes before deleting the storage server from the DXi6900.

To delete a storage server:

1. Select the storage server in the **Storage Server List**.

You cannot delete a storage server if it has more than zero currently active connections. The number of active connections is displayed on the **OST** page (see [Storage Server List on page 261](#)). Also, you cannot delete a storage server if it contains LSUs. Before deleting the storage server, you must first delete any LSUs it contains (see [Deleting an LSU on page 272](#)).

---

**i Note:** You can select multiple storage servers to delete at once.

2. Click **Delete**.

## LSU

The **LSU** page allows you to manage the logical storage units (LSUs) contained on OST storage servers on the DXi6900. You can view information about existing LSUs, add or edit LSUs, and delete LSUs.

To access the **LSU** page, on the **OST** page, click the **LSU** tab (see [Figure 166 on the next page](#)).

Figure 166: LSU Page

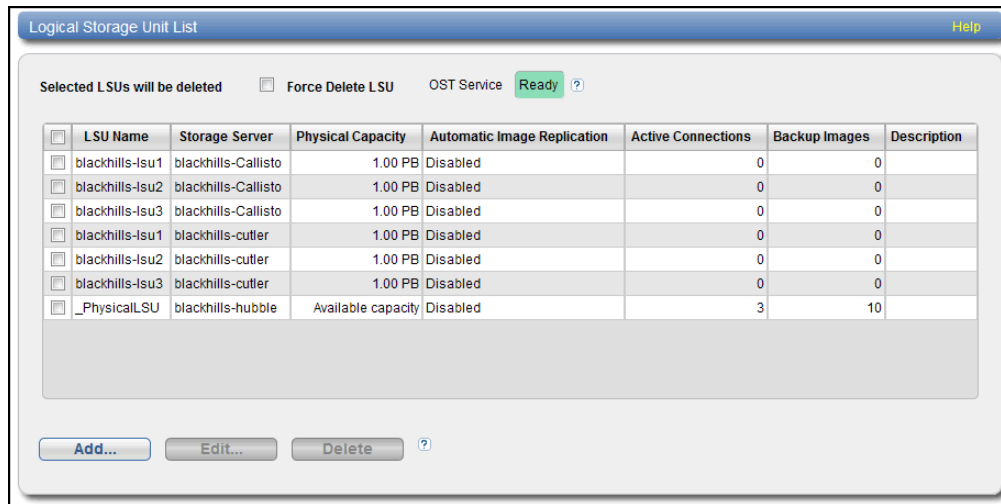

### Tasks

Use the **LSU** page to perform the following tasks:

- View information about existing LSUs (see [Logical Storage Unit List below](#)).
- Add a new LSU to the system (see [Adding an LSU on the next page](#)).
- Edit properties for an existing LSU (see [Editing an LSU on page 270](#)).
- Delete an LSU from the system (see [Deleting an LSU on page 272](#)).

## Logical Storage Unit List

The **Logical Storage Unit List** displays the following information for all LSUs on the DXi6900:

<b>OST Service</b>	The status of the OST service. OST settings can be configured in <b>Ready</b> , <b>Stopped</b> , or <b>Verifying</b> state. The OST server is available for backup only in <b>Ready</b> state.
<b>LSU Name</b>	The name of the LSU.
<b>Storage Server</b>	The storage server that contains the LSU.
<b>Physical Capacity</b>	The physical storage capacity of the LSU.

<b>Automatic Image Replication</b>	The status of Automatic Image Replication (AIR) for the LSU ( <b>Enabled</b> or <b>Disabled</b> ), as well as the configured targets (if any). <b>i</b> <b>Note:</b> To view details about the remote LSU if AIR is enabled, use the <b>Edit Logical Storage Unit</b> page (see <a href="#">Editing an LSU on page 270</a> ).
<b>Active Connections</b>	The number of currently active connections to the LSU.
<b>Backup Images</b>	The number of backup images on the LSU.
<b>Description</b>	A brief description of the LSU (if available).

### Additional Information

- Click a column heading to sort the rows in the table by that column. Click the column heading again to reverse the sort order.
- The connections of a storage server that are used equals the data streams plus one for each LSU polling. A backup job may generate more than one data stream if the data can be read in parallel. For example, a policy that is backing up A, B, C, and D drives of a Windows system can generate four data streams in parallel.

## Adding an LSU

Add an LSU to a storage server to present the storage capacity of the DXi6900 as an LSU that is compatible with backup applications that support OST. You can add an LSU with a specific capacity, or you can add an LSU that uses the available capacity of the DXi6900.

**i** **Note:** You must create a storage server before you can add an LSU (see [Adding a Storage Server on page 262](#)).

To add an LSU to a storage server:

1. Click **Add**.

The **Add Logical Storage Unit** page displays (see [on the next page](#)).

## Add Logical Storage Unit Page

2. Enter information about the LSU.

---

### Storage Server

Select the storage server that will contain the new LSU.

---

### Available Capacity

(Recommended for best performance) Select this option to add an LSU that uses the available capacity on the system.

You cannot add an available capacity LSU to a storage server that already contains an LSU. Also, if you add an available capacity LSU to a storage server, you cannot add additional LSUs to that same storage server.

**i Note:** After you add an LSU that uses the **Available Capacity** option, you cannot change the LSU to use the **Specific Capacity** option. Instead, you must delete the LSU, then add a new LSU and choose the **Specific Capacity** option (see [Deleting an LSU on page 272](#)).

---

### Specific Capacity

Select this option to specify the physical capacity of the LSU, and then enter the following information.

- **LSU Name** - Enter the name of the LSU.
  - **Physical Capacity** - Enter the physical capacity of the LSU (1 to 1048576 GB).
- i Note:** Quantum recommends setting LSUs to maximum size (1048576 GB) because spanning them on a backup is not possible.

3. (Optional) In the **Description** box, enter a brief description of the LSU.
4. (Optional) Select the **Enable Automatic Image Replication** check box to automatically replicate

(duplicate) data on the LSU to a remote LSU on another DXi.

Automatic Image Replication (AIR) is disabled by default. If enabled, data on an LSU is automatically replicated to a remote LSU that resides on a DXi in a different NetBackup domain. The timing of the duplication, as well as the backup images that are duplicated, are determined by the storage lifecycle policies (SLPs) configured in NetBackup.

OST AIR requires NetBackup 7.1 or higher. For information about configuring NetBackup for Automatic Image Replication, see the *DXi-Series NetBackup and Backup Exec OST Configuration Guide* (6-67079).

---

**i Note:** You must configure at least one remote user before you can enable Automatic Image Replication (see [Manage Remote Users on page 275](#)).

5. If Automatic Image Replication is enabled, select the replication target you want to replicate images to. (You can select only a single target.) When images are replicated, data will be sent to the selected target.
6. If Automatic Image Replication is enabled, specify the following information:

---

<b>Remote Storage Server Name</b>	The name of the remote storage server (on the target DXi) to replicate data to. The source DXi and target DXi must reside in different NetBackup domains. <b>i Note:</b> To configure the target DXi, see <a href="#">Replication Send on page 145</a> .
<b>Remote LSU Name</b>	The name of the LSU in the remote storage server that will receive the replicated data.
<b>Remote User</b>	The OST user credentials to use for authentication on the remote (target) DXi. The selected remote user <i>must</i> match a local user on the <b>Configuration &gt; OST &gt; Manage Users</b> page on the target DXi (see <a href="#">Manage Users (DXi6900-S) on page 357</a> )(see <a href="#">Manage Users (DXi6900) on page 272</a> ).

---

7. Click **Apply**.

## Editing an LSU

Edit an LSU to change its capacity, description, or automatic image replication settings.

To edit an LSU:

1. Select the LSU and click **Edit**.

The **Edit Logical Storage Unit** page displays (see [below](#)).

Edit Logical Storage Unit Page

The screenshot shows the 'Edit Logical Storage Unit' dialog box. The fields are as follows:

- Name: blackhills-lsu1
- Storage Server Name: blackhills-Callisto
- \* Physical Capacity: 1048576 (1 to 1048576 GB)
- Description: (empty)
- Enable Automatic Image Replication
- Replication Target DXIs: (List with two entries, both '10.') (The first entry is selected)
- \* Remote Storage Server Name: (empty)
- \* Remote LSU Name: \_PhysicalLSU
- Remote User: admin
- \* Required Field

Buttons: Apply, Reset, Cancel

2. Enter information about the LSU:

**Note:** If you are editing an LSU, the **Name** option cannot be changed.

**Physical Capacity** (Specific capacity LSUs only) Enter the physical capacity of the LSU (1 to 1048576 GB).

The physical capacity cannot be changed if the LSU has more than zero currently active connections. The number of active connections is displayed on the **LSU** page (see [Logical Storage Unit List on page 267](#)).

**Description** (Optional) Enter a brief description of the LSU.

3. (Optional) Select the **Enable Automatic Image Replication** check box to automatically replicate (duplicate) data on the LSU to a remote LSU on another DXi.

Automatic Image Replication (AIR) is disabled by default. If enabled, data on an LSU is automatically replicated to a remote LSU that resides on a DXi in a different NetBackup domain. The timing of the duplication, as well as the backup images that are duplicated, are determined by the storage lifecycle policies (SLPs) configured in NetBackup.

OST AIR requires NetBackup 7.1 or higher. For information about configuring NetBackup for Automatic Image Replication, see the *DXi-Series NetBackup and Backup Exec OST Configuration Guide* (6-67079).

**Note:** You must configure at least one remote user before you can enable Automatic Image Replication (see [Manage Remote Users on page 275](#)).

4. If Automatic Image Replication is enabled, select the replication target you want to replicate images to. (You can select only a single target.) When images are replicated, data will be sent to the selected target.

5. If Automatic Image Replication is enabled, specify the following information:

---

<b>Remote Storage Server Name</b>	The name of the remote storage server (on the target DXi) to replicate data to. The source DXi and target DXi must reside in different NetBackup domains. <b>i Note:</b> To configure the target DXi, see <a href="#">Replication Send on page 145</a> .
<b>Remote LSU Name</b>	The name of the LSU in the remote storage server that will receive the replicated data.
<b>Remote User</b>	The OST user credentials to use for authentication on the remote (target) DXi. The selected remote user <i>must</i> match a local user on the <b>Configuration &gt; OST &gt; Manage Users</b> page on the target DXi (see <a href="#">Manage Users (DXi6900-S) on page 357</a> ).

---

6. Click **Apply**.

## Deleting an LSU

Delete an LSU if it is no longer needed. When you delete an LSU, all data stored on the LSU is lost.

**i Note:** If you deleted the LSU from Symantec NetBackup or Symantec Backup Exec, you must wait several minutes before deleting the LSU from the DXi6900.

To delete an LSU:

1. Select the LSU in the **Logical Storage Unit List**.

You cannot delete an LSU if it has more than zero currently active connections. The number of active connections is displayed on the **LSU** page (see [Logical Storage Unit List on page 267](#)).

**i Note:** You can select multiple LSUs to delete at once.

2. (Optional) Select the **Force Delete LSU** check box to delete LSUs that are not empty.

Normally, you cannot delete an LSU if it contains existing backup images. If for some reason you cannot remove files from the LSU, selecting the **Force Delete LSU** check box allows you to delete the LSU even though it is not empty.

3. Click **Delete**.

## Manage Users (DXi6900)

The **Manage Users** page allows you to create and manage local authenticated users for use with OST. After you create the OST user credentials, enter them in the backup application to authenticate OST devices on the media server. When using OST Automatic Image Replication (AIR), the remote user credentials specified on the source DXi must match the local user credentials on the target (remote) DXi.

To access the **Manage Users** page, on the **OST** page, click the **Manage Users** tab (see [Figure 167 on the next page](#)).



**Figure 167:** Manage Users Page

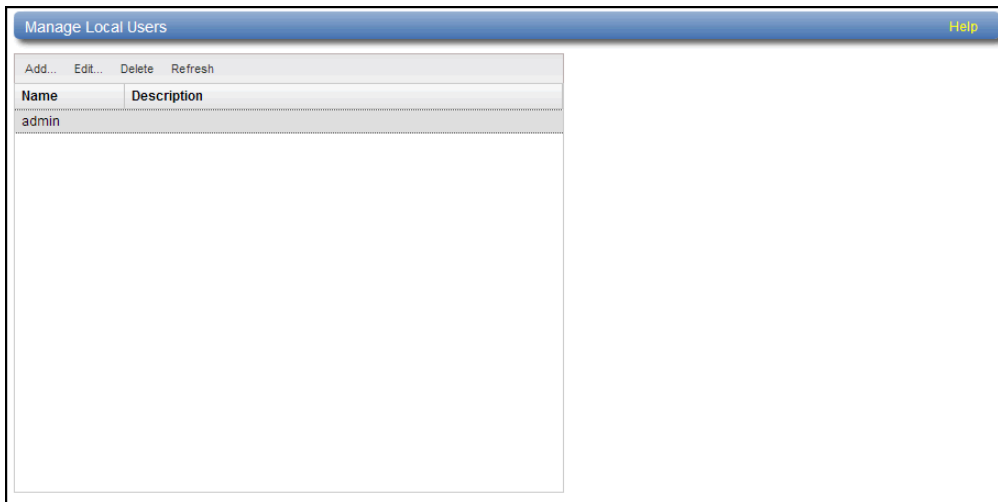

### Tasks

Use the **Manage Users** page to perform the following tasks:

- View information about local authenticated users (see [Manage Local Users List below](#)).
- Add a local authenticated user (see [Adding an Authenticated User below](#)).
- Edit a local authenticated user (see [Editing an Authenticated User on the next page](#)).
- Delete a local authenticated user (see [Deleting an Authenticated User on page 275](#)).

## Manage Local Users List

The **Manage Local Users** list displays the following information for all local authenticated users:

<b>Name</b>	The name of the local authenticated user.
<b>Description</b>	A brief description of the local authenticated user (if available).

**Note:** To update the list with the latest information, click **Refresh**.

## Adding an Authenticated User

Add an authenticated user to create local OST user credentials. The OST user credentials are required to authenticate OST devices on a media server, or to enable the DXi to receive duplicated data using OST AIR.

To add an authenticated user:

1. Click **Add**.

The **Add User Credential** window displays (see [Figure 168 below](#)).

**Figure 168:** Add User Credential

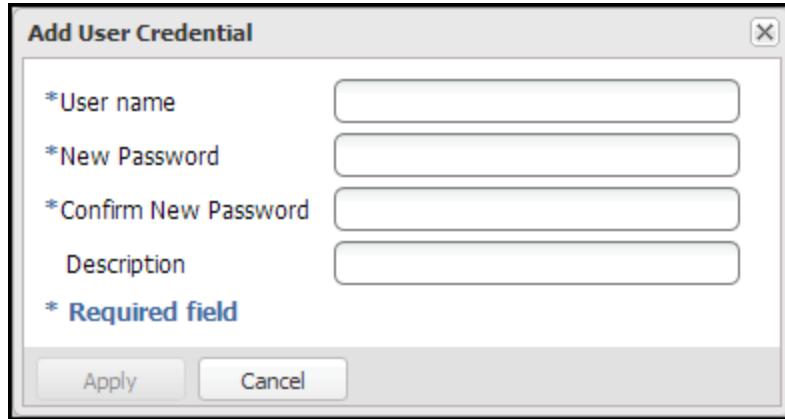

The screenshot shows a dialog box titled "Add User Credential" with a close button (X) in the top right corner. It contains four input fields: "\*User name", "\*New Password", "\*Confirm New Password", and "Description". The first three fields are marked as required with an asterisk. Below the fields is a legend: "\* Required field". At the bottom of the dialog are two buttons: "Apply" and "Cancel".

2. Enter information about the authenticated user:

<b>User name</b>	Enter the name of the authenticated user.
<b>New Password</b>	Enter the password for the authenticated user.
<b>Confirm New Password</b>	Enter the password again to confirm it.
<b>Description</b>	(Optional) Enter a brief description of the authenticated user.

3. Click **Apply**.

## Editing an Authenticated User

Edit an authenticated user to change the user's password or description.

To edit an authenticated user:

1. Select the user and click **Edit**.

The **Edit User Credentials** window displays (see [below](#)).

Edit User Credentials

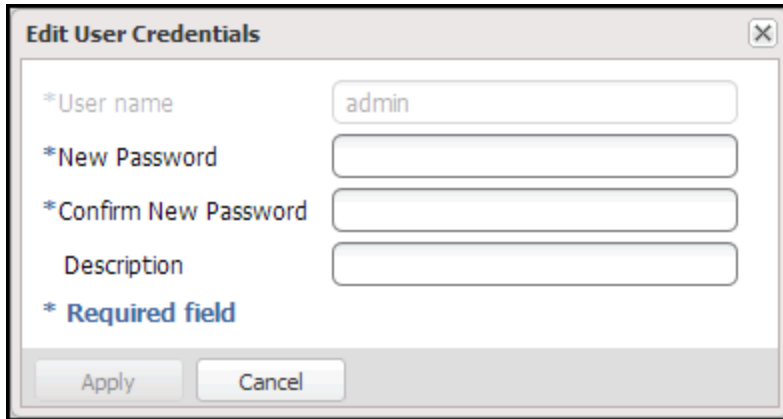

2. Enter information about the authenticated user:

---

**i Note:** If you are editing an authenticated user, you cannot change the **User name**.

---

<b>New Password</b>	Enter the password for the authenticated user.
<b>Confirm New Password</b>	Enter the password again to confirm it.
<b>Description</b>	(Optional) Enter a brief description of the authenticated user.

---

3. Click **Apply**.

## Deleting an Authenticated User

Delete an authenticated user if the OST user credentials are no longer needed to authenticate OST devices on a media server.

To delete an authenticated user, select the user and click **Delete**.

---

**i Note:** You can select multiple users to delete at once.

## Manage Remote Users

The **Manage Remote Users** page allows you to create and manage remote users for use with OST Automatic Image Replication (AIR). You must configure at least one remote user before you can enable Automatic Image Replication for an LSU (see [Adding an LSU on page 268](#)). When using OST Automatic Image Replication (AIR), the remote user credentials specified on the source DXi must match the local user credentials on the target (remote) DXi.

To access the **Manage Remote Users** page, on the **OST** page, click the **Manage Remote Users** tab (see [Figure 169 on the next page](#)).

**Figure 169:** Manage Remote Users Page

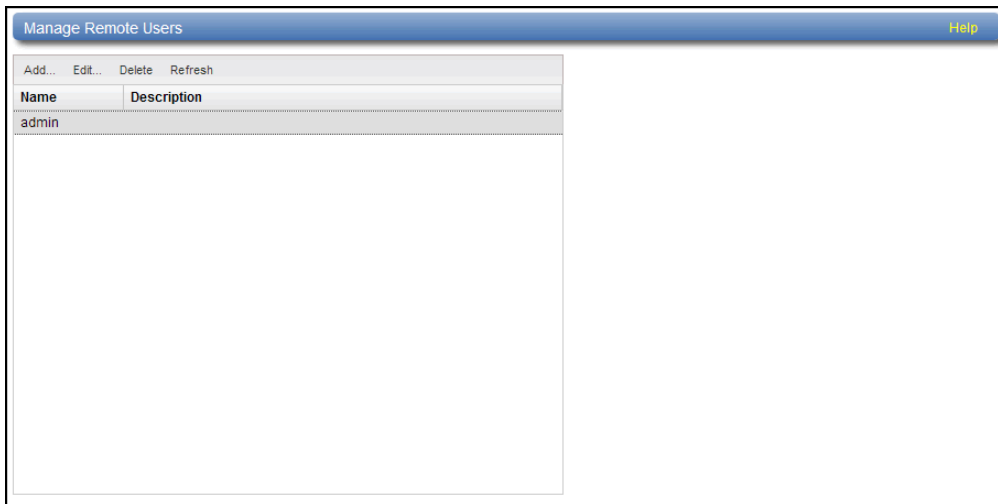

### Tasks

Use the **Manage Users** page to perform the following tasks:

- View information about remote users (see [Manage Remote Users List below](#)).
- Add a remote user (see [Adding a Remote User below](#)).
- Edit a remote user (see [Editing a Remote User on the next page](#)).
- Delete a remote user (see [Deleting a Remote User on page 278](#)).

## Manage Remote Users List

The **Manage Remote Users** list displays the following information for all remote users:

<b>Name</b>	The name of the remote user.
<b>Description</b>	A brief description of the remote user (if available).

**Note:** To update the list with the latest information, click **Refresh**.

## Adding a Remote User

Add a remote user to create OST user credentials for use with OST AIR. When you enable Automatic Image Replication for an LSU, you specify a remote user. The remote user credentials on the source DXi must match the local user credentials on the target (remote) DXi.

To add a remote user:

1. Click **Add**.

The **Add Remote AIR Credential** window displays (see [below](#)).

Add Remote AIR Credential

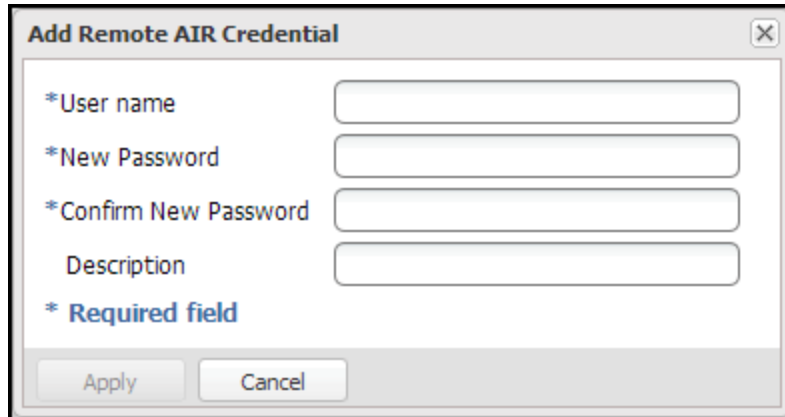

The screenshot shows a dialog box titled "Add Remote AIR Credential". It has a close button (X) in the top right corner. The dialog contains four input fields: "\*User name", "\*New Password", "\*Confirm New Password", and "Description". The first three fields are marked as required with an asterisk. Below the fields, there is a legend: "\* Required field". At the bottom of the dialog, there are two buttons: "Apply" and "Cancel".

2. Enter information about the remote user:

<b>User name</b>	Enter the name of the remote user. <b>i Note:</b> An AIR user name can contain the following characters: 'a-z', 'A-Z', '0-9', '_', and '.'
<b>New Password</b>	Enter the password for the remote user.
<b>Confirm New Password</b>	Enter the password again to confirm it.
<b>Description</b>	(Optional) Enter a brief description of the remote user.

3. Click **Apply**.

## Editing a Remote User

Edit a remote user to change the user's password or description.

To edit a remote user:

1. Select the user and click **Edit**.

The **Edit Remote Credentials** window displays (see [below](#)).

Edit Remote Credentials

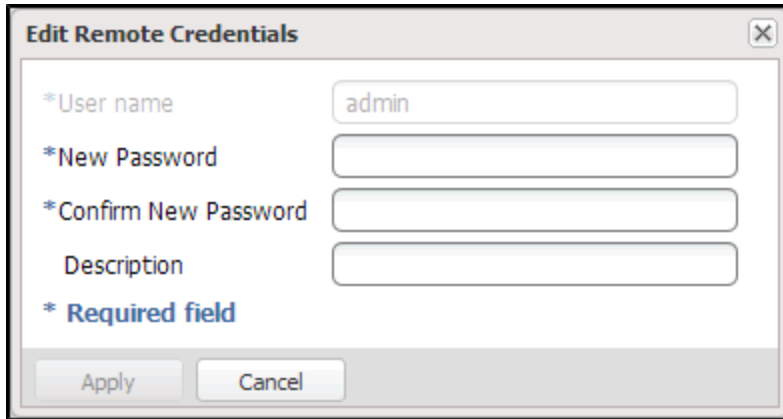

2. Enter information about the remote user:

---

**i Note:** If you are editing a remote user, you cannot change the **User name**.

---

<b>New Password</b>	Enter the password for the remote user.
<b>Confirm New Password</b>	Enter the password again to confirm it.
<b>Description</b>	(Optional) Enter a brief description of the remote user.

---

3. Click **Apply**.

## Deleting a Remote User

Delete a remote user if the OST user credentials are no longer needed to authenticate an LSU for Automatic Image Replication.

To delete a remote user, select the user and click **Delete**.

---

**i Note:** You can select multiple users to delete at once.

## Target IP Mapping

The **Target IP Mapping** page allows you to map a target data IP address to route all network traffic sent to the data IP address to the specified replication IP address instead. This can be necessary if the target DXi is configured with different network interfaces (and therefore different IP addresses) for data and replication traffic (see [Network on page 322](#)).

Generally, OST traffic is routed to the data network segment. However, the OST Automatic Image Replication (AIR) and Concurrent Optimized Duplication features use the replication network segment to transmit data to the target system. (Optimized duplication can optionally use the replication channel.) When a data IP address is mapped to a replication IP address, OST traffic that is sent to one of the IP addresses is routed to the other IP address as necessary.

### Additional Information

- You must add target IP mapping information if you are performing optimized duplication on a segmented network and replication is not configured between the source DXi and target DXi.
- Quantum does not recommend mapping multiple data IP addresses to a single replication IP address. If you have mapped multiple data IP addresses and the routing is not working, try removing the additional data IP addresses, and map only a single data IP address.
- To switch from using the replication channel to the OST channel for optimized duplication, replication must be unconfigured.

To access the **Target IP Mapping** page, on the **OST** page, click the **Target IP Mapping** tab (see [Figure 170 below](#)).

**Figure 170:** Target IP Mapping Page

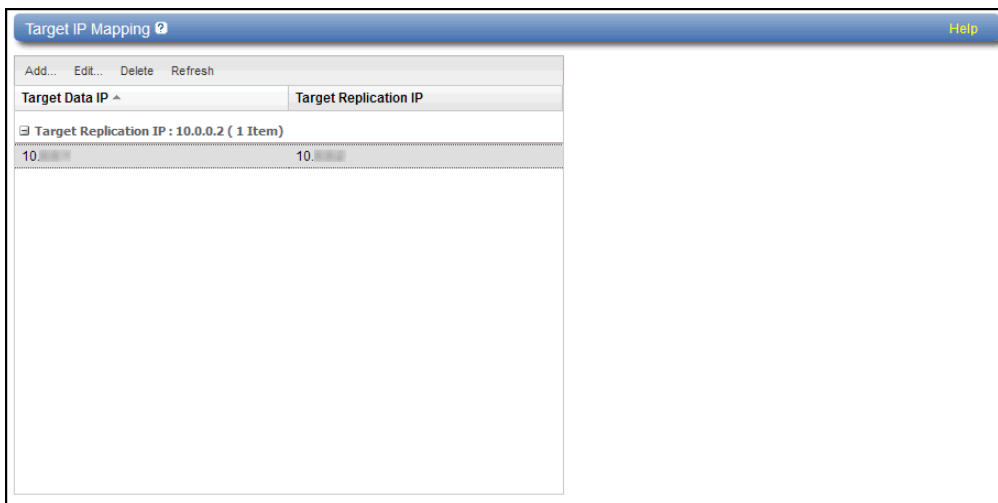

### Tasks

Use the **Target IP Mapping** page to perform the following tasks:

- View information about mapped data and replication IP addresses (see [Target IP Mapping List on the next page](#)).
- Map a target data IP address to a replication IP address (see [Mapping a Target IP Address on the next page](#)).
- Edit the mapping for a target data IP address (see [Editing a Mapped IP Address on the next page](#)).
- Delete the mapping for a target data IP address (see [Editing a Mapped IP Address on the next page](#)).

## Target IP Mapping List

The **Target IP Mapping** list displays the following information for all mapped IP addresses:

- **Target Data IP** - The mapped target data IP address.
- **Target Replication IP** - The replication IP address to which the data IP address is mapped.

By default, items in the list are grouped by target replication IP address. To turn off grouping, click the arrow to the right of a column heading and clear the **Show in groups** check box.

**Note:** To update the list with the latest information, click **Refresh**.

## Mapping a Target IP Address

Add mapping for a target data IP address to route all network traffic sent to the address to the specified replication IP address instead.

To map a target IP address:

1. Click **Add**.

The **Add Target Data IP Mapping** window displays (see [Figure 171 below](#)).

**Figure 171:** Add Target Data IP Mapping

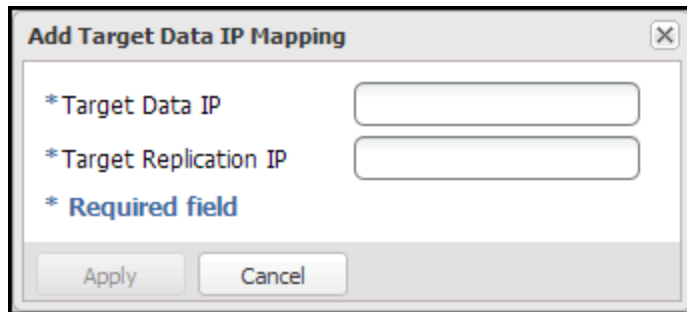

The screenshot shows a dialog box titled "Add Target Data IP Mapping". It has a close button (X) in the top right corner. Inside the dialog, there are two text input fields. The first is labeled "\* Target Data IP" and the second is labeled "\* Target Replication IP". Below these fields is a legend for "\* Required field". At the bottom of the dialog, there are two buttons: "Apply" and "Cancel".

2. Enter information about the mapping:

<b>Target Data IP</b>	The target data IP address to map.
<b>Target Replication IP</b>	The replication IP address to map the data IP address to.

3. Click **Apply**.

## Editing a Mapped IP Address

Edit a mapped IP address to route traffic sent to the target data IP address to a different replication IP address.

To edit a mapped IP address:



1. Select the mapped IP address and click **Edit**.

The **Edit Target Data IP Mapping** window displays (see [Figure 172 below](#)).

**Figure 172:** Edit Target Data IP Mapping

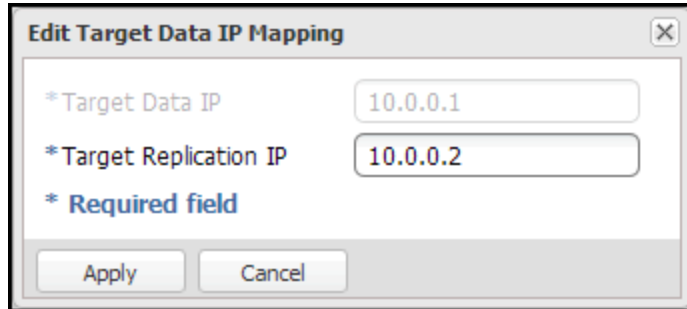

2. In the **Target Replication IP** box, enter the replication IP address to map the data IP address to.

---

**Note:** If you are editing a mapped IP address, you cannot change the target data IP address.

3. Click **Apply**.

## Deleting a Mapped IP Address

Delete a mapped IP address if traffic sent to the target data IP address no longer needs to be routed to a replication IP address

To delete a mapped IP address, select the IP address and click **Delete**.

---

**Note:** You can select multiple mapped IP addresses to delete at once.

## DXi Accent

Use the **Accent** page to enable or disable DXi Accent. Quantum's DXi Accent software accelerates backups and reduces network bandwidth requirements by distributing deduplication between the backup server and the DXi. OST data sent from the media server to the DXi can be encrypted using AES (Advanced Encryption Standard) encryption methods.

To access the **Accent** page, on the **OST** page, click the **Accent** tab (see [Figure 173 below](#)).

**Figure 173:** Accent Page

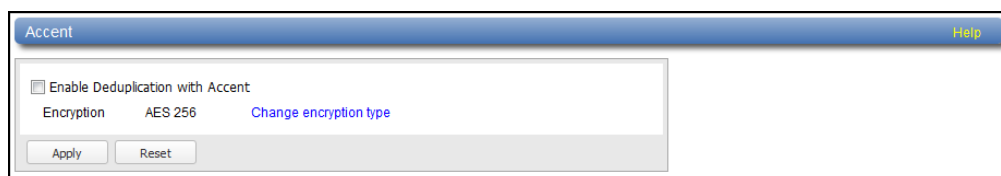

To configure DXi Accent:

1. To enable DXi Accent, select the **Enable Deduplication with Accent** check box.

Or to disable DXi Accent, clear the **Enable Deduplication with Accent** check box.

**i Note:** You cannot use DXi Accent if you are currently using NetBackup Accelerator or Optimized Synthetic Backups. If you are using Accelerator, please make sure that Accent is not enabled. For more information on using NetBackup Accelerator, see the *DXi-Series Configuration and Best Practices Guide for NetBackup from Veritas (6-67850)*.

2. Click **Apply**.

### Additional Information

- Click the **Change Encryption Type** link to change the OST data encryption type (see [Data Encryption on page 350](#)).
- To use DXi Accent, you must install the Quantum OST Client Plug-in on the media server. For information about installing the OST Plug-in and using DXi Accent, see the *DXi-Series NetBackup and Backup Exec OST Configuration Guide (6-67079)*.

## OST Client Plug-In (DXi6900)

Use the **OST Client Plug-In** page to download the Quantum OST Plug-in.

OST (OpenStorage) technology allows Symantec NetBackup and Backup Exec to seamlessly integrate with the DXi6900. Using OST, NetBackup and Backup Exec can manage backups through the DXi6900 and can take advantage of the system's capabilities, such as data deduplication and replication. To use OST, you must first download the OST Plug-in and install it on the NetBackup or Backup Exec media server.

To download the OST Plug-in, click **Client Plug-in Download**. On the download page, download the correct OST Plug-in for your backup application and operating system. Also on the download page, click **Installation Instructions**, to download the *OST Plug-in Installation Instructions*. Follow the included instructions to install the OST Plug-in on your media server.

**i Note:** For information about configuring and using OST with the DXi6900, see the *DXi-Series NetBackup and Backup Exec OST Configuration Guide (6-67079)*.

---

## Replication Configuration

The **Replication Configuration** page allows you to configure and manage replication targets and allowed replication sources on the DXi6900. A source *sends* replicated data to 1 or 2 targets, and a target *receives* replicated data from up to 10 sources. A DXi6900 can act as both a source and a target.

## Additional Information

- For more information about data replication, or to perform data replication, see [Replication on page 138](#).
- If the DXi is configured as a replication target *and* replication is performed across a public network, with the source and target located behind NAT-enabled routers, you *must* specify a NAT IP address for the DXi on the **Network** page (see [Configuring Interface IP Addresses on page 326](#)).

To access the **Replication Configuration** page, click the **Configuration** menu, and then click the **Replication** tab (see [Figure 174 below](#)).

**Figure 174:** Replication Configuration Page

The screenshot shows the 'Replication Target and Source DXIs (Send and Receive)' configuration page. It is divided into two main sections: 'Target DXIs' and 'Source DXIs'.

**Target DXIs:** This section is titled 'DXIs allowed to receive replication from this DXI'. It includes a toolbar with 'Add...', 'Edit...', 'Delete', 'Pause', 'Resume', and 'Throttling' (set to 'None'). Below is a table with columns: Target, Status, Source IP, Encryption, Original Data Size, Actual Data Sent, and Average Send Rate. Two entries are shown, both with a status of 'Ready' and '256-BIT' encryption.

Target	Status	Source IP	Encryption	Original Data Size	Actual Data Sent	Average Send Rate
10.10.10.10	Ready	10.10.10.10	256-BIT	0.00 B	0.00 B	0.00 B/s
10.10.10.10	Ready	10.10.10.10	256-BIT	0.00 B	0.00 B	0.00 B/s

**Source DXIs:** This section is titled 'DXIs allowed to replicate to this DXI'. It includes a toolbar with 'Add...' and 'Delete', and a 'Maximum Snapshots' dropdown menu set to '10'. Below is a table with columns: Source, Actual Data Received, and Average Receive Rate. Three entries are shown: 'Luna', 'gambit', and 'oberon', all with '0.00 B' received and '0.00 B/s' rate.

Source	Actual Data Received	Average Receive Rate
Luna	0.00 B	0.00 B/s
gambit	0.00 B	0.00 B/s
oberon	0.00 B	0.00 B/s

## Tasks

Use the **Replication Configuration** page to perform the following tasks:

- View information about configured replication target systems (see [Target DXIs List on the next page](#)).
- Add, edit, or delete a replication target (see [Adding a Replication Target on the next page](#), [Editing a Replication Target on page 286](#), or [Deleting a Replication Target on page 287](#)).
- Pause or resume replication to a target (see [Pausing or Resuming Replication to a Target on page 288](#)).
- Configure a constant replication throttle (see [Enabling System Throttling on page 288](#)).
- View information about allowed replication source systems (see [Source DXIs List on page 289](#)).
- Add or delete an allowed replication source (see [Adding a Replication Source on page 290](#) or [Deleting a Replication Source on page 291](#)).
- Specify the maximum number of received snapshots to retain for each source (see [Changing the Maximum Number of Snapshots on page 291](#)).

## Target DXis List

The **Target DXis** list displays the following information for each target DXi:

<b>Target</b>	The IP address of the target system that the DXi6900 is configured to send data to.
<b>Status</b>	The replication status of the DXi6900. For a detailed description of all possible replication statuses, see <a href="#">Replication Overview on page 131</a> .
<b>Source IP</b>	The IP address that is used to uniquely identify the source DXi to the target.
<b>Encryption</b>	The type of encryption used when sending replicated data to the target system ( <b>None</b> , <b>128-bit</b> , or <b>256-bit</b> ).
<b>Original Data Size</b>	The original, native size of data sent during replication or failback. This value does not represent the amount of data actually sent over the network during replication or failback because data is deduplicated and compressed before being sent.
<b>Actual Data Sent</b>	The amount of data actually sent over the network during replication or failback. This value is usually much less than the <b>Original Data Size</b> due to the benefits of data deduplication and compression.
<b>Average Send Rate</b>	The average send rate (in B/s) of data sent over the network during replication or failback ( <b>Actual Data Sent</b> divided by the amount of time required to complete replication or failback).

You can customize the appearance of the **DXis** list in the following ways:

- Click the top banner row of the list to collapse or expand the list.
- Click the arrow to the right of a column heading and select **Sort Ascending** or **Sort Descending** to sort the rows in the table by that column.
- To show or hide a column, click the arrow to the right of a column heading, and then click **Columns**. Select the check box to show a column, or clear the check box to hide a column.

**i Note:** The statistics in the **Target DXis** list are for each target DXi rather than a cumulative total for all targets as is displayed on the **Home** page.

## Adding a Replication Target

Add a replication target to configure the DXi6900 to send replicated data to that target. You can add up to two targets. After you add a target, you can enable replication to that target for a NAS share or VTL partition. When replication is enabled for a share or partition, replicated data is sent to the target system during scheduled or manual replication.

### Additional Information

- Before you can add a replication target, you must add the DXi to the list of allowed replication sources on the target DXi (see [Adding a Replication Source on page 290](#)).
- To add a new target when two targets are already configured, first delete one target (see [Deleting a Replication Target on page 287](#)). Then add the new target.
- For more information about enabling and scheduling replication for a share or partition, see [Replication Send on page 145](#).

To add a replication target:

1. Under **Target DXis**, click **Add**.

The **Add Target Host** window displays (see [Figure 175 below](#)).

**Figure 175:** Add Target Host

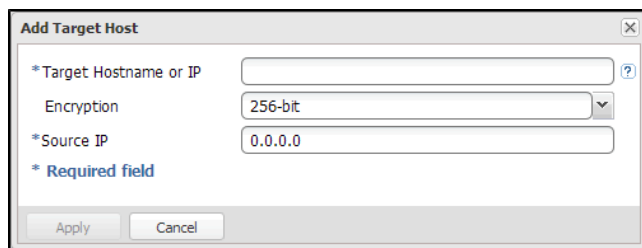

2. In the **Target Hostname or IP** box, enter the hostname or IP address of the system that will receive the replicated data.

#### Additional Information

- When entering IP addresses, never use an address that is in a reserved IP address range. To see a list of reserved IP address ranges, click the quick tip icon [?] located near the IP address field.
- To use hostname format, you must specify at least one DNS IP address on the **Network** page (see [Network on page 322](#)).

3. In the **Encryption** drop-down box, select the type of encryption to use when sending replication data to the target system (**None**, **128-bit**, or **256-bit**).

**Caution:** For encryption, select **None** or **128-bit** if you are sending data to a DXi running a system software version prior to DXi 2.1 Software.

**Note:** AES encryption options are available only if the Data-in-Flight license is installed (see [License Keys on page 377](#)).

4. In the **Source IP** box, enter the IP address that is used to uniquely identify the source DXi to the target.

This may be different than the actual network IP address of the source DXi.

If the target system is at DXi 2.1 Software or higher, the **Source IP** field is not required. If the target system is at DXi 2.0.1.x Software or below, then you must enter the IP address by which the target system recognizes the source system. The default value is **0.0.0.0**.

### Additional Information

- The **Source IP** field does not accept fully qualified domain names. You must enter a valid IP address. Make sure this IP address is configured in the allowable sources list on the target DXi.
- When configuring segmented network interfaces, if the source DXi replication, data, and management interfaces are on the same subnet, you must add a host route on the source DXi to make sure the replication interface is correctly selected when replicating data to the target DXi (see [Understanding Interface Routing on page 330](#)).

5. Click **Apply**.

**i Note:** The new target is not automatically added to existing replication schedules. You must add or edit scheduled events to schedule replication to the new target (see [Scheduler on page 297](#)).

## Editing a Replication Target

Edit a replication target to change encryption options or the source IP address.

To edit a replication target:

1. Under **Target DXis**, select the target and click **Pause** to pause replication.
2. Select the target again and click **Edit**.

The **Edit Target Host** window displays (see [Figure 176 below](#)).

**i Note:** If you are editing a target, you cannot change the **Target Hostname or IP**.

**Figure 176:** Edit Target Host

*Target Hostname or IP	10.40.165.181
Encryption	256-bit
*Source IP	0.0.0.0

\* Required field

Apply Cancel

3. In the **Encryption** drop-down box, select the type of encryption to use when sending replication data to the target system (**None**, **128-bit**, or **256-bit**).

---

 **Caution:** For encryption, select **None** or **128-bit** if you are sending data to a DXi running a system software version prior to DXi 2.1 Software.

---

 **Note:** AES encryption options are available only if the Data-in-Flight license is installed (see [License Keys on page 377](#)).

4. In the **Source IP Address** box, enter the IP address that is used to uniquely identify the source DXi to the target. This may be different than the actual network IP address of the source DXi.

If the target system is at DXi 2.1 Software or higher, the **Source IP Address** field is not required. If the target system is at DXi 2.0.1.x Software or below, then you must enter the IP address by which the target system recognizes the source system. The default value is **0.0.0.0**.

#### Additional Information

- The **Source IP Address** field does not accept fully qualified domain names. You must enter a valid IP address. Make sure this IP address is configured in the allowable sources list on the target DXi.
- When configuring segmented network interfaces, if the source DXi replication, data, and management interfaces are on the same subnet, you must add a host route on the source DXi to make sure the replication interface is correctly selected when replicating data to the target DXi (see [Understanding Interface Routing on page 330](#)).

5. Click **Apply**.
6. Under **Target DXis** , select the target and click **Resume** to pause replication.

## Deleting a Replication Target

Delete a replication target if the DXi6900 no longer needs to send replicated data to that target. After the target system is deleted, the DXi6900 will no longer send replicated data to that system.

When a target is deleted:

- All replication jobs to that target that are in progress or queued will transition to failed.
- All replication job history for that combination of target and share or partition is removed.
- All shares or partitions will be reconfigured to no longer replicate to that target.

To delete a replication target:

1. Under **Target DXis** , select one or more targets to delete.
2. Click **Pause** to pause replication to the target.
3. Click **Delete**.

---

 **Note:** The deleted target is not automatically removed from existing replication schedules. You must edit scheduled events to remove the deleted target (see [Scheduler on page 297](#)).

## Pausing or Resuming Replication to a Target

The source DXi controls the replication pause behavior.

- To pause replication, select a target under **Target DXis** and click **Pause**. The DXi temporarily stops sending replicated data to the selected target.
- To resume replication, select a target under **Target DXis** and click **Resume**. The DXi resumes sending replicated data to the selected target.

### Additional Information

- If namespace replication is paused midway through a replication job, the job will fail.
- If namespace replication is paused before the replication job starts, the job will sit in the queue until replication is resumed. When resumed the job will start and replication will occur.
- Trigger replication can be paused midway through a replication job. When resumed the job will continue from where it was paused.

## Enabling System Throttling

Enable system throttling to limit the network bandwidth used for replication to all targets. When a constant throttle is enabled, the DXi limits the amount of data it sends during source replication so that it does not exceed the specified bandwidth.

### Additional Information

- If multiple targets are configured, replication to all targets counts against the same bandwidth limit.
- To vary the replication throttle rate over time, use the **Configuration > Scheduler** page (see [Scheduler on page 297](#)). Do *not* enable a constant throttle if a throttle schedule is configured. The scheduled replication throttling bandwidth settings take precedence over the constant throttle value. (The currently active replication throttle rate appears on the **Home** page under **Current Activity**.)

To enable system replication throttling:

1. Under **Target DXis**, click the box next to **Throttling**.

The **Replication Throttle** window displays (see [Figure 177 on the next page](#)).



Figure 177: Replication Throttle

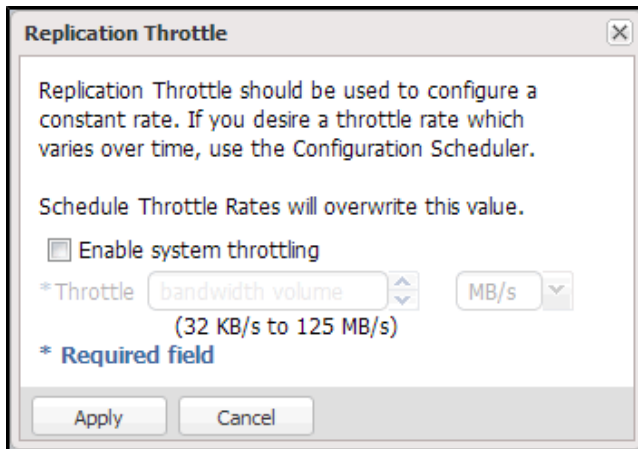

2. Select the **Enable system throttling** check box, or clear the check box to disable system throttling.
3. In the **Throttle** box, enter the maximum allowed bandwidth, and select the units you want to use to specify the constant throttle (**KB/s** or **MB/s**). The lowest value you can set is 32 KB/s. The lowest value you can set is 32 KB/s. The highest value you can set is 125 MB/s for 1GbE and 500 MB/s for 10GbE.
4. Click **Apply**.

**Caution:** Do not set the maximum allowed bandwidth to a value that is lower than necessary. If the maximum allowed bandwidth is set to the lowest value, large replication jobs may fail.

## Source DXis List

The **Source DXis** list displays the following information for each source DXi:

<b>Source</b>	The IP address of the source system that is allowed to send data to the DXi6900.
<b>Actual Data Received</b>	The amount of data actually received over the network during replication or failback.
<b>Average Receive Rate</b>	The average receive rate (in MB/s) of data received over the network during replication or failback ( <b>Actual Data Received</b> divided by the amount of time required to complete replication or failback).

You can customize the appearance of the **Source DXis** list in the following ways:

- Click the top banner row of the list to collapse or expand the list.
- Click the arrow to the right of a column heading and select **Sort Ascending** or **Sort Descending** to sort the rows in the table by that column.

- To show or hide a column, click the arrow to the right of a column heading, and then click **Columns**. Select the check box to show a column, or clear the check box to hide a column.

**i Note:** The statistics in the **Source DXis** list are for each source DXi rather than a cumulative total for all sources as is displayed on the **Home** page.

## Adding a Replication Source

Add a system to the list of replication sources to allow it to send replicated data to the DXi6900. You must add a source system to the list of allowed replication sources on the target DXi before you configure the source DXi to send replicated data to the target. The DXi can receive replicated data from up to 10 sources.

### Additional Information

- For more information about working with received snapshots, see [Receive NAS on page 153](#) or [Receive VTL on page 163](#).
- It is typical for the target DXi to require additional disk space for replication data compared to the source DXi. This is because complete replication data is sent to the target before old data is deleted. For optimal performance, if the DXi is a replication target, Quantum recommends keeping the amount of free space at 20% or more (see [Disk Usage on page 190](#)).

To add a replication source:

1. Under **Source DXis** , click **Add**.

The **Add Allowed Source** window displays (see [Figure 178 below](#)).

**Figure 178:** Add Allowed Source

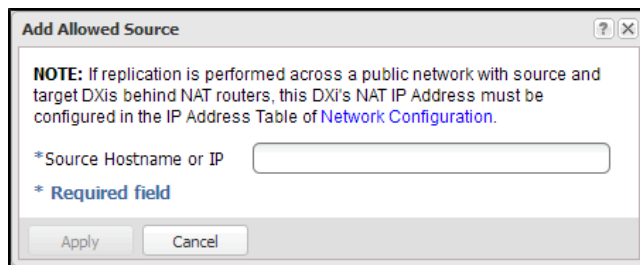

2. In the **Source Hostname or IP** box, enter the hostname or IP address of the system that will send the replicated data to the DXi6900.

**i Note:** To use hostname format, you must specify at least one DNS IP address on the **Network** page (see [Network on page 322](#)).

3. Click **Apply**.

## Deleting a Replication Source

Delete a system from the list of replication sources if it will no longer send replicated data to the DXi6900. After the source system is deleted, the DXi6900 will no longer accept replicated data from that system.

To delete a replication source:

1. Under **Source DXis** , select one or more sources to delete.
2. Click **Delete**.

---

**i Note:** If a source DXi is deleted from the list, its contribution to the cumulative totals on the **Home** page are not removed until you clear **Receive** statistics (see [Replication Performance on page 175](#)).

## Changing the Maximum Number of Snapshots

During scheduled or manual data replication, the DXi6900 receives a snapshot from the source system. A snapshot contains all of the data necessary to fully recover or failback a NAS share or VTL partition to the point in time when the snapshot was saved.

The DXi6900 can retain up to 32 snapshots for each replicated share or partition. Once the maximum number of snapshots have been saved, the oldest snapshot is deleted to make room for each new snapshot that is received.

To change the maximum number of received snapshots:

- Under **Source DXis** , in the **Maximum Snapshots** drop-down box, select the number of snapshots to retain for each replicated share or partition.
- The default value is 10. The maximum value is 32.

---

**i Note:** Retaining more than the default number of snapshots will use additional disk space on the target DXi. This can cause the target DXi to fill up more quickly.

---

# PTT Configuration

The **PTT** page allows you to configure the path to tape (PTT) feature of the DXi6900. There are two types of path to tape:

- Backup application specific path to tape allows you to move data from the DXi to physical tape cartridges in an attached physical tape library using an NDMP (Network Data Management Protocol) connection. The DXi supports NDMP V4.
- OST path to tape (also called Direct To Tape) allows you to use Symantec NetBackup to copy LSUs from a storage server on the DXi to a physical tape library.

### Additional Information

- DXi6900 supports a maximum of 24 tape devices.
- For information about working with storage servers and LSUs, see [OST Configuration on page 257](#).
- NDMP backup jobs can take longer or fail altogether if media and tape drives are not in optimal condition. Replace old media and clean the tape drives in the attached library.
- For detailed information about configuring and using OST path to tape, see the *DXi-Series NetBackup and Backup Exec OST Configuration Guide (6-67079)*.
- OST path to tape options can only be configured when the **OST** and **Backup Application Specific** licenses have been enabled (see [License Keys on page 377](#)).

To access the **PTT** page, click the **Configuration** menu, and then click the **PTT** tab.

The **PTT** page contains the following tabs:

- [Physical Device Discovery below](#)
- [Backup Application Specific \(DXi6900\) on the next page](#)

## Physical Device Discovery

The **Physical Device Discovery** page allows you to discover attached physical tape libraries and tape drives. After you discover the libraries and drives, you can use them for path to tape data movement.

To access the **Physical Device Discovery** page, on the **PTT** page, click the **Physical Device Discovery** tab (see [Figure 179 below](#)).

**Figure 179:** Physical Device Discovery Page

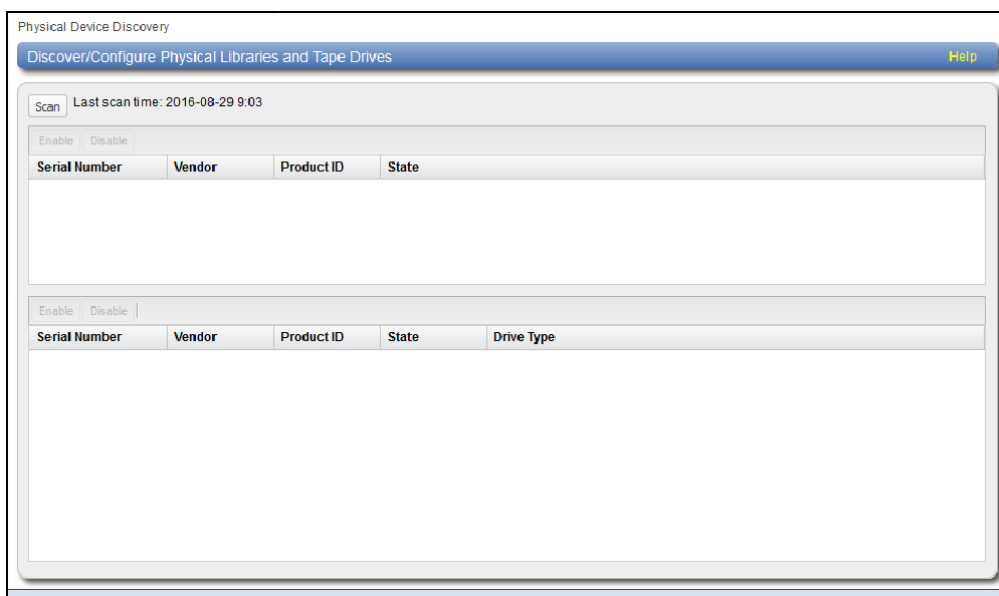

The **Physical Device Discovery** page displays the following information for all discovered physical libraries and tape drives:

Physical Library and Tape Drive Information	Description
<b>Last scan time</b>	The date and time a scan for attached libraries was last performed.
<b>Serial Number</b>	The serial number of the library or drive.
<b>Vendor</b>	The vendor of the library or drive.
<b>Product ID</b>	The product ID (name) of the library or drive.
<b>State</b>	The state of the library or drive ( <b>Enabled</b> or <b>Disabled</b> ).
<b>Drive Type</b>	(Tape drives only) The drive type of the drive.

### Tasks

Use the **Physical Device Discovery** page to perform the following tasks:

- To discover an attached physical tape library and tape drives, click **Scan**. Attached physical libraries display in the list.
- To enable or disable a physical library, select it in the list, and then click **Enable** or **Disable**. (You can also right-click a library to enable or disable it.)
- To use a physical library, it must be enabled. If you enable or disable a library, all tape drives in the library are also enabled or disabled.
- To view the drives in an attached library, select the library in the list. All drives in the selected library display below.
- To enable or disable tape drives, select one or more drives in the list, and then click **Enable** or **Disable**. (You can also right-click a drive to enable or disable it.)

**i Note:** To use a tape drive, it must be enabled. To enable a drive, the parent library must be enabled.

- To remove a physical library from the list, first disconnect the Fibre Channel cables that connect the library to the DXi6900, and then click **Scan**.
- To update the libraries or drives list with the latest information, click **Refresh**.

## Backup Application Specific (DXi6900)

The **Backup Application Specific** page allows you to create and manage authenticated users for use with the path to tape capability.

The following applications are supported for backup application specific path to tape:

- Veritas NetBackup
- Veritas Backup Exec
- EMC Networker
- Oracle Secure Backup
- ASG-Time Navigator

**Note:** You must dedicate a partition within the DXi6900 for use with NetBackup Direct to Tape (Path to Tape). The partition cannot be shared with another backup application.

**Caution:** The virtual media changer and tape drives *must* be assigned to the backup server (on the SAN) being used for Backup Application Specific path to tape functionality.

To access the **Backup Application Specific** page, on the **PTT** page, click the **Backup Application Specific** tab (see [Figure 180 below](#)).

**Figure 180:** Backup Application Specific Page

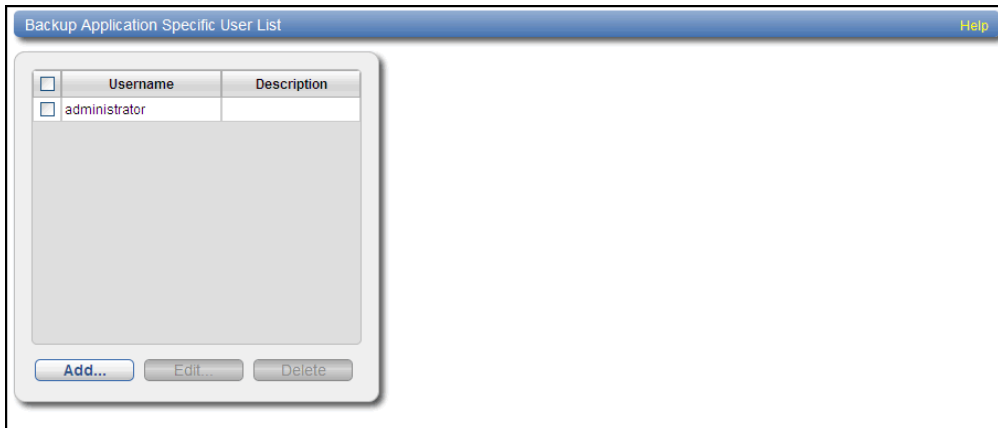

## Tasks

Use the **Backup Application Specific** page to perform the following tasks:

- View information about backup application specific users (see [Backup Application Specific User List on the next page](#)).
- Add a backup application specific user (see [Adding a Backup Application Specific User on the next page](#)).
- Edit a backup application specific user (see [Editing a Backup Application Specific User on page 296](#)).
- Delete a backup application specific user (see [Deleting a Backup Application Specific User on page 296](#)).

## Backup Application Specific User List

The **Backup Application Specific User** section displays the following information for all backup application specific users:

<b>Username</b>	The name of the backup application specific user.
<b>Description</b>	A brief description of the backup application specific user (if available).

**Note:** To update the list with the latest information, click **Refresh**.

## Adding a Backup Application Specific User

Add a backup application specific user to create user credentials. The user credentials are required to authenticate devices on a media server.

To add a backup application specific user:

1. Click **Add**.

The **Add Backup Application Specific User** page displays (see [Figure 181 below](#)).

**Figure 181:** Add Backup Application Specific User Page

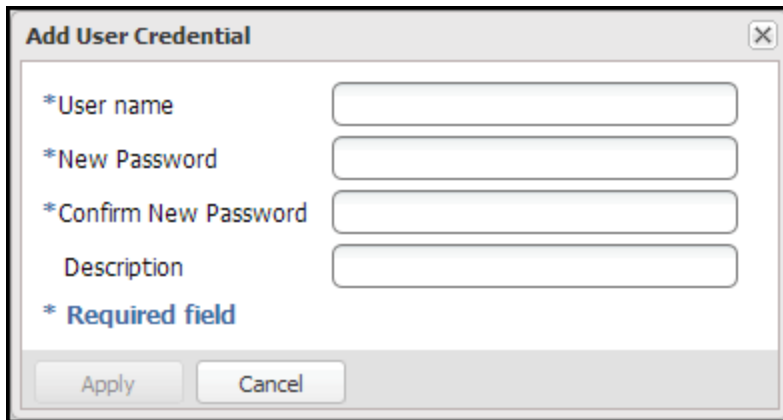

The screenshot shows a dialog box titled "Add User Credential" with a close button (X) in the top right corner. It contains four input fields: "\*User name", "\*New Password", "\*Confirm New Password", and "Description". The first three fields are marked as required with an asterisk. Below the fields is a legend: "\* Required field". At the bottom of the dialog are two buttons: "Apply" and "Cancel".

2. Enter information about the backup application specific user:

<b>Username</b>	Enter the name of the backup application specific user.
<b>New Password</b>	Enter the password for the backup application specific user.
<b>Confirm Password</b>	Enter the password again to confirm it.
<b>Description</b>	(Optional) Enter a brief description of the backup application specific user.

3. Click **Apply**.

## Editing a Backup Application Specific User

Edit a backup application specific user to change the user's password or description.

To edit a backup application specific user:

1. Select the user and click **Edit**.

The **Edit Backup Application Specific User** page displays (see [Figure 182 below](#)).

**Figure 182:** Edit Backup Application Specific User Page

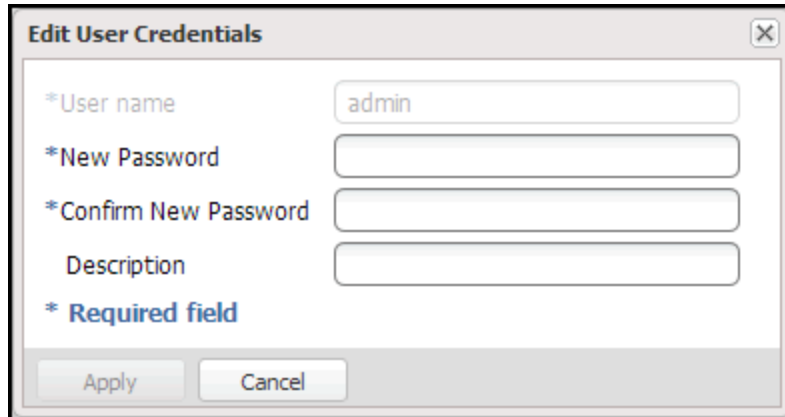

The screenshot shows a dialog box titled "Edit User Credentials" with a close button in the top right corner. It contains the following fields and labels:

- \*User name: Input field containing "admin"
- \*New Password: Empty input field
- \*Confirm New Password: Empty input field
- Description: Empty input field

A legend at the bottom left indicates "\* Required field". At the bottom of the dialog are "Apply" and "Cancel" buttons.

2. Enter information about the backup application specific user:

**Note:** If you are editing a backup application specific user, you cannot change the **Username**.

<b>Username</b>	(Optional) Select a different backup application specific user to edit.
<b>New Password</b>	Enter the password for the backup application specific user.
<b>Confirm New Password</b>	Enter the password again to confirm it.
<b>Description</b>	(Optional) Enter a brief description of the backup application specific user.

3. Click **Apply**.

## Deleting a Backup Application Specific User

Delete a backup application specific user if the user credentials are no longer needed to authenticate devices on a media server.

To delete a backup application specific user, select the user and click **Delete**.

**Note:** You can select multiple users to delete at once.



# Scheduler

The **Scheduler** page allows you to manage scheduled events on the DXi6900, including replication and replication throttling, e-mail reports, healthchecks, and space reclamation. With schedules, you specify when certain events should occur, and the system automatically performs those events at the specified time. Events can be one-time only, or they can reoccur at defined intervals.

To access the **Scheduler** page, click the **Configuration** menu, and then click the **Scheduler** tab (see [Figure 183 below](#)).

**Figure 183:** Scheduler Page

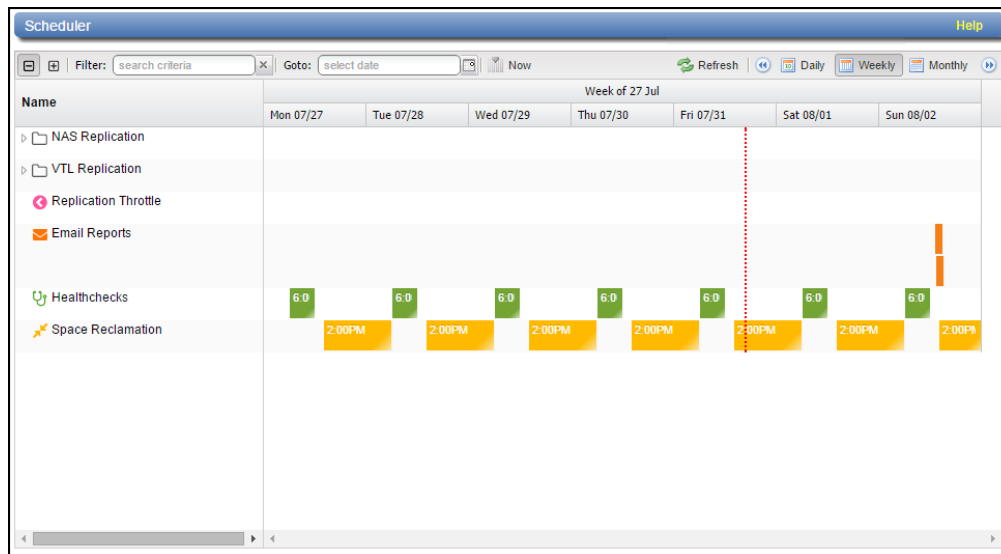

## Tasks

Use the **Scheduler** page to perform the following tasks:

- View currently scheduled events (see [Viewing Scheduled Events on the next page](#)).
- Add a new scheduled event or edit an existing event (see [Adding or Editing a Scheduled Event on the next page](#)).
- Configure NAS shares or VTL partitions for scheduled replication (see [Scheduling a Share or Partition for Replication on page 300](#)).
- Configure replication throttle events (see [Scheduling Replication Throttling on page 301](#)).
- Configure the DXi6900 to send status and configuration reports (see [Scheduling E-mail Reports on page 302](#)).
- Configure the DXi6900 to run healthchecks (see [Scheduling Healthchecks on page 302](#)).
- Configure the DXi6900 to run space reclamation (see [Scheduling Space Reclamation on page 303](#)).

- Specify when and how often an event reoccurs (see [Setting Recurrence for a Scheduled Event on page 303](#)).
- Remove an event occurrence or event series from the schedule (see [Deleting a Scheduled Event on page 304](#)).

## Viewing Scheduled Events

The **Scheduler** page displays all replication, replication throttle, e-mail report, healthchecks, and space reclamation events scheduled to occur in a selected time period. To view scheduled replication events for NAS shares or VTL partitions, click the arrow next to the folder to display all shares or partitions.

### Tasks

Use the following toolbar controls to adjust the schedule view (see [Figure 184 below](#)):

- To show or hide all shares or partitions, click the plus [ + ] or minus [ - ] icons.
- To filter shares or partitions based on name, begin typing in the **Filter** box. Click the **x** to clear the filter.
- To view the schedule for a specific day, select it in the **Goto** pop-up calendar.
- To view the schedule for today, click **Now**.
- To update the schedule view with the latest data, click the **Refresh** icon.
- To move the view backward or forward in time, click the arrows.
- To change the number of days displayed at a time, click **Daily**, **Weekly**, or **Monthly**.

**Note:** The thickness of the bars on the schedule view varies based on the type of event and the selected time frame. Healthcheck events have an estimated span of 6 hours. Space Reclamation events have an estimated span of 16 hours. All other open-ended events have a default span of 2 hours.

**Figure 184:** Scheduler Toolbar

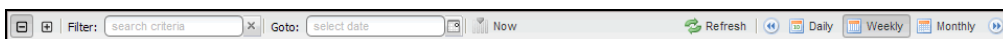

## Adding or Editing a Scheduled Event

To add or edit a scheduled event:

1. On the **Scheduler** page, adjust the schedule view to display the time period when the event will occur (see [Viewing Scheduled Events above](#)). Then do one of the following actions (see [Figure 185 on the next page](#)):

### Add a New Event

- To add a new event, click and drag on the schedule in the row for the type of event to add. A new event is added where you dragged the cursor.
- To schedule replication for NAS shares or VTL partitions, click the arrow next to the folder to display all shares or partitions. Then click and drag in the row for the share or partition to schedule.
- The new event must begin after the current time, which is indicated by the dotted vertical line.

### Edit an Existing Event

- To edit an existing event, double-click the event. If the event is recurring, select **Open this occurrence** to edit only the one instance of the event, or select **Open the series** to edit the entire recurring series, and then click **OK**.
- You cannot edit an event that occurred in the past.
- You can also right-click an existing event to see options for editing an event.

Figure 185: Adding a New Event

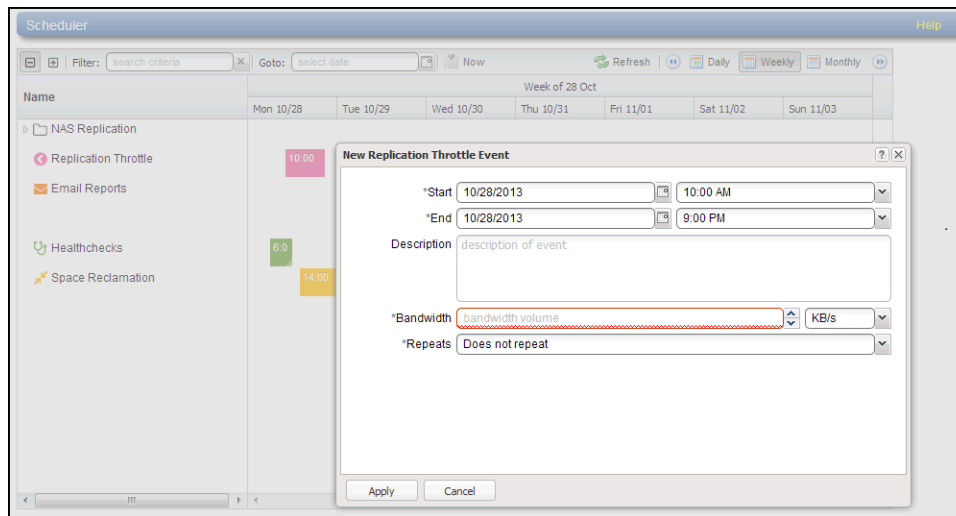

2. Define the start and, if applicable, the end of the event.
  - Specify the **Start Date** and **Start Time** using the pop-up calendar and drop-down box.
  - (Replication throttle events only) Specify the **End Date** and **End Time**. The end date and time must occur after the start date and time.

---

**i Note:** For a new event, you can click and drag to adjust the start and end time. For an existing event, you can drag the event to change when it occurs. You can also drag the left or right edge of the event to adjust the start or end time.

3. Enter a brief description of the event in the **Description** box. (This description will display on the schedule view.)
4. Specify options specific to the type of event. See the following sections:
  - [Scheduling a Share or Partition for Replication below](#)
  - [Scheduling Replication Throttling on the next page](#)
  - [Scheduling E-mail Reports on page 302](#)
  - [Scheduling Healthchecks on page 302](#)
  - [Scheduling Space Reclamation on page 303](#)
5. (Required for healthchecks and space reclamation) Specify when and how often the event reoccurs (see [Setting Recurrence for a Scheduled Event on page 303](#)).
6. Click **Apply**.
7. Refresh the browser window to make sure the event settings are applied.

---

**! Caution:** When adding multiple events of the same type, make sure the events do not overlap. If two events of the same type overlap, the later event takes precedence over the earlier event.

---

**i Note:** After a system reboot, all open-ended events (for example, replication) will restart at their next scheduled time. Events with end times (for example, replication throttle) that are past their start time will have their end action occur.

## Scheduling a Share or Partition for Replication

Configure a replication schedule for a NAS share or VTL partition to automatically replicate the share or partition data to the target system at regular intervals. Disable scheduled replication if you do not want to automatically replicate the share or partition data to the target.

---

**i Note:** Note: To schedule a share or partition for replication, you must first add one or more replication targets (see [Replication Configuration on page 282](#)). In addition, you must add one or more shares or partitions with deduplication enabled and at least one target selected (see [NAS Summary on page 216](#) or [Partitions on page 231](#)).

---

**i Note:** Disabling replication for a share or partition, or deleting a share or partition, does not delete any scheduled replication events for that share or partition. If you no longer want to schedule the share or partition for replication, manually delete the schedule (see [Deleting a Scheduled Event on page 304](#)).

To configure a replication schedule for a share or partition:

1. On the **Scheduler** page, add or edit an event in the **NAS Replication** or **VTL Replication** row (see [Adding or Editing a Scheduled Event on page 298](#)).

2. In the **Share or Partition** drop-down box, select the share or partition to schedule for replication.  
Only shares or partitions that are enabled for deduplication appear in the drop-down box.

---

**Note:** Scheduling a share or partition that has replication disabled will automatically enable replication.

3. In the **Target** drop-down box, select the replication target you want to replicate the share or partition to.
4. Click **OK**.
5. (Optional) Specify when and how often the event reoccurs (see [Setting Recurrence for a Scheduled Event on page 303](#)).
6. Click **Apply**.

## Scheduling Replication Throttling

During replication throttling, the DXi6900 limits the amount of source replication data it sends to not exceed a specified maximum bandwidth. Schedule replication throttling to control the amount of network bandwidth used by source replication at certain times. For example, you might configure replication throttling to occur during planned backup times to avoid network contention.

---

**Note:** For more information about configuring the DXi6900 for replication, see [Replication on page 138](#).

To schedule replication throttling:

1. On the **Scheduler** page, add or edit an event in the **Replication Throttle** row (see [Adding or Editing a Scheduled Event on page 298](#)).
2. Specify the maximum allowed bandwidth by entering a value in the **Bandwidth** box and selecting the units in the drop-down box (**KB/s** or **MB/s**). The lowest value you can set is 32 KB/s. The highest value you can set is 125 MB/s for 1 GbE and 500 MB/s for 10 GbE.

---

**Caution:** Do not set the maximum allowed bandwidth to a value that is lower than necessary. If the maximum allowed bandwidth is set to the lowest value, large replication jobs may fail.

During the replication throttle event, the DXi will limit the amount of data it sends during source replication so that it does not exceed the specified bandwidth. After the replication throttle event ends, the DXi will no longer throttle the sending of source replication data (until the next replication throttle event occurs).

Do *not* configure a throttle schedule if a constant throttle is enabled (see ). The scheduled replication throttling bandwidth settings take precedence over the constant throttle value. (The currently active replication throttle rate appears on the **Home** page under **Current Activity**.)

3. (Optional) Specify when and how often the event reoccurs (see [Setting Recurrence for a Scheduled Event on page 303](#)).
4. Click **Apply**.

## About Replication Throttling Statistics

Keep in mind the following information when observing actual network bandwidth usage during a replication throttle event:

- During a replication throttle event, only outgoing replication data traffic is throttled, not other outgoing traffic. Because of this, you may observe network usage to be higher than the specified maximum bandwidth. Differences in the sampling time period may also cause discrepancies between the specified maximum bandwidth and observed traffic.
- If the DXi is configured to use a bonded network interface for replication traffic, load balancing is determined independently by the bonding mode selected for the interface (see [Network on page 322](#)). Because of this, you may need to sum the values for all slave devices in the bonded interface to calculate the overall outgoing traffic rate.
- The replication throttle bandwidth maximum is specified in KB/s or MB/s, so depending on the statistic or report you are observing, you may need to convert the bandwidth maximum to Kb/s or Mb/s in order to correctly compare it to the observed values.

## Scheduling E-mail Reports

The DXi6900 can automatically generate a report with system status data or with configuration data and send it to all configured e-mail recipients.

---

**i Note:** To enable the DXi6900 to send e-mail, you must specify an outgoing e-mail server (see [Server on page 308](#)). In addition, you must specify one or more recipients (see [Email Reports on page 310](#)[Email on page 304](#)).

To configure a schedule for e-mail reports:

1. On the **Scheduler** page, add or edit an event in the **Email Reports** row (see [Adding or Editing a Scheduled Event on page 298](#)).
2. In the **Report Type** drop-down box, select the type of e-mail report to schedule (**Status** or **Configuration**).
3. (Optional) Specify when and how often the event reoccurs (see [Setting Recurrence for a Scheduled Event on the next page](#)).
4. Click **Apply**.

## Scheduling Healthchecks

During healthchecks, the DXi6900 performs tests to verify the health and integrity of the data deduplication blockpool. Schedule healthchecks regularly to make sure the system is healthy and operating correctly. When you schedule healthchecks, only the healthchecks that are currently enabled are run.

---

**i Note:** For more information about enabling healthchecks, see [Healthchecks on page 369](#).

To configure a schedule for healthchecks:

1. On the **Scheduler** page, add or edit an event in the **Healthchecks** row (see [Scheduler on page 297](#)).
2. Specify when and how often the event reoccurs (see [Scheduler on page 297](#)).

---

 **Caution:** For correct system operation, healthchecks *must* be run at regular intervals (at least once a week). You can schedule healthchecks to occur daily or weekly but not monthly or yearly. Also, recurrence is required.

3. Click **Apply**.

## Scheduling Space Reclamation

During space reclamation, the DXi6900 deletes unneeded tags from the blockpool to free up disk space. Schedule space reclamation regularly to make sure there is enough disk space to store data.

---

 **Caution:** Because space reclamation can affect system performance, avoid running space reclamation during known backup periods.

---

 **Note:** For more information about space reclamation, see [Space Reclamation on page 374](#).

To configure a schedule for space reclamation:

1. On the **Scheduler** page, add or edit an event in the **Space Reclamation** row (see [Scheduler on page 297](#)).
2. Specify when and how often the event reoccurs (see [Scheduler on page 297](#)).

---

 **Caution:** For correct system operation, space reclamation *must* be run at regular intervals (at least once a week). You can schedule space reclamation to occur daily or weekly but not monthly or yearly. Also, recurrence is required.

3. Click **Apply**.

## Setting Recurrence for a Scheduled Event

To specify when and how often the event reoccurs:

1. On the **Scheduler** page, add or edit an event (see [Scheduler on page 297](#)).
2. In the **Repeats** drop-down box, select **Does not repeat** to disable recurrence. Or to enable recurrence, select how often the event reoccurs:

---

 **Note:** Healthchecks and space reclamation must occur at least every seven days or once a week.

- **Daily** - Specify the recurrence interval in days.
  - **Weekly** - Specify the recurrence interval in weeks, and select the days the event occurs on.
3. For recurring events, specify how long the recurrence continues (**forever**, **for** a certain number of occurrences, or **until** a specific date).

---

 **Note:** For healthchecks and space reclamation, recurrence is always **forever**.

4. Click **Apply**.

## Deleting a Scheduled Event

To delete an event occurrence or event series.

1. On the **Scheduler** page, right-click an event.
2. On the pop-up menu, select an option:
  - **Delete this occurrence** - Remove the selected occurrence in an event series from the schedule.
  - **Delete all occurrences** - Remove the entire event series from the schedule.

The event or series is deleted from the schedule and will no longer occur.

---

# Notifications

The **Notifications** page allows you to manage the methods the DXi6900 uses to send notifications. The DXi6900 can send notifications by e-mail, or using SNMP (Simple Network Management Protocol).

To access the **Notifications** page, click the **Configuration** menu, and then click the **Notifications** tab.

The **Notifications** page contains the following tabs:

- [Email below](#)
- [SNMP on page 312](#)

## Email

The **Email** page allows you to specify the recipients to notify by e-mail when administration alerts or service tickets occur. You can specify e-mail recipients, notification levels, and information about your e-mail configuration. You can also configure the DXi6900 to generate and send configuration and status reports.

**i Note:** For more information about administration alerts and service tickets, see [Alerts on page 205](#).

To access the **Email** page, on the **Notifications** page, click the **Email** tab.

The **Email** page contains the following tabs:

## Recipients

The **Recipients** page allows you to manage the e-mail recipients the DXi6900 sends notifications to. You can add, edit, and delete e-mail recipients, and you can specify the types of notifications to send.



**Note:** To enable the DXi6900 to send e-mail, you must specify an outgoing e-mail server (see [Email on the previous page](#)).

To access the **Recipients** page, on the **Email** page, click the **Recipients** tab (see [Figure 186 below](#)).

**Figure 186:** Recipients Page

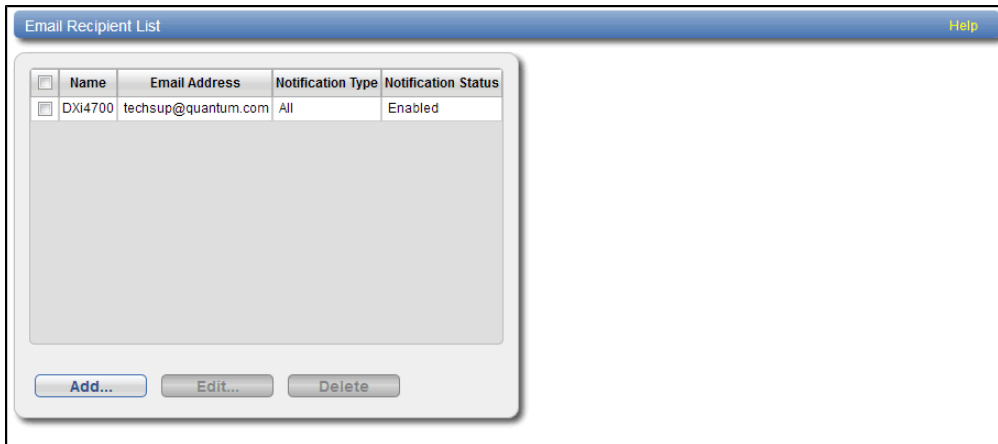

## Tasks

Use the **Recipients** page to perform the following tasks:

- View information about e-mail recipients (see [Email Recipient List below](#)).
- Add an e-mail recipient (see [Adding an E-mail Recipient below](#)).
- Edit an e-mail recipient (see [Editing an E-mail Recipient on page 307](#)).
- Delete an e-mail recipient (see [Deleting an E-mail Recipient on page 308](#)).

## Email Recipient List

The **Email Recipient List** displays the following information about e-mail recipients:

<b>Name</b>	The name of the recipient.
<b>Email Address</b>	The e-mail address of the recipient.
<b>Notification Type</b>	The types of notifications sent to the recipient ( <b>High</b> , <b>High and Medium</b> , or <b>All</b> ).
<b>Notification Status</b>	The status of e-mail notifications for the recipient ( <b>Enabled</b> or <b>Disabled</b> ).

## Adding an E-mail Recipient

Add an e-mail recipient to send notifications about administration alerts or service tickets to the recipient by

e-mail.

To add an e-mail recipient:

1. Click **Add**.

The **Add Email Recipient** page displays (see [Figure 187 below](#)).

**Figure 187:** Add Email Recipient Page

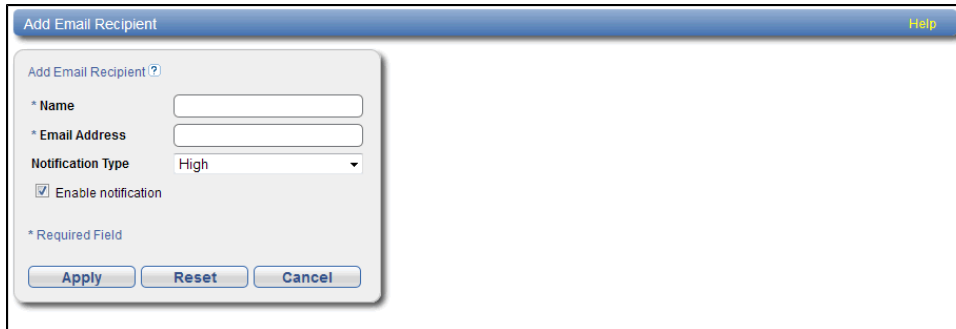

2. Enter information about the recipient:

<b>Name</b>	The name of the recipient.
<b>Email Address</b>	The e-mail address of the recipient.
<b>Notification Type</b>	Select the types of notifications to send to the recipient: <b>Notification Type</b> <ul style="list-style-type: none"><li>• <b>High</b> - Send e-mail notifications for High service tickets. High service tickets indicate that a critical problem has occurred and needs to be resolved immediately. The operation and performance of the DXi6900 are degraded, and there is a risk of system failure or data loss.</li><li>• <b>High and Medium</b> - Send e-mail notifications for High and Medium service tickets. Medium service tickets indicate that a serious problem occurred and needs to be resolved, but it does not necessarily need to be fixed immediately. The operation and performance of the DXi6900 may be degraded.</li><li>• <b>All</b> - Send e-mail notifications for High, Middle, and Low service tickets, as well as any administration alerts. Low service tickets indicate that a minor problem occurred and needs to be resolved, but the operation and performance of the DXi6900 are not significantly affected.</li></ul>

3. Select the **Enable notification** check box to enable sending of notifications to the recipient.  
Or clear the **Enable notification** check box to disable sending of notifications to the recipient.
4. Click **Apply**.

### Editing an E-mail Recipient

Edit an e-mail recipient to change the recipient's e-mail address or the types of notifications sent to the recipient. You can also enable or disable sending of notifications to the recipient.

To edit an e-mail recipient:

1. Click **Edit**.

The **Edit Email Recipient** page displays (see [Figure 188 below](#)).

**Figure 188:** Edit Email Recipient Page



2. Enter information about the recipient:

---

**i Note:** If you are editing an e-mail recipient, you cannot change the **Name**.

---

**Name** (Optional) Select a different e-mail recipient to edit.

---

**Email Address** The e-mail address of the recipient.

---

---

### Notification Type

Select the types of notifications to send to the recipient:

#### Notification Type

- **High** - Send e-mail notifications for High service tickets.

High service tickets indicate that a critical problem has occurred and needs to be resolved immediately. The operation and performance of the DXi6900 are degraded, and there is a risk of system failure or data loss.

- **High and Medium** - Send e-mail notifications for High and Medium service tickets

Medium service tickets indicate that a serious problem occurred and needs to be resolved, but it does not necessarily need to be fixed immediately. The operation and performance of the DXi6900 may be degraded.

- **All** - Send e-mail notifications for High, Middle, and Low service tickets, as well as any administration alerts.

Low service tickets indicate that a minor problem occurred and needs to be resolved, but the operation and performance of the DXi6900 are not significantly affected.

---

3. Select the **Enable notification** check box to enable sending of notifications to the recipient.  
Or clear the **Enable notification** check box to disable sending of notifications to the recipient.
4. Click **Apply**.

### Deleting an E-mail Recipient

Delete an e-mail recipient if you no longer want the DXi6900 to send e-mail notifications to the recipient.

To delete an e-mail recipient, select the recipient and click **Delete**.

---

**i Note:** You can select multiple recipients to delete at once.

## Server

The **Server** page allows you to specify the server for outgoing e-mail. The DXi6900 cannot send e-mail notifications until you specify the outgoing e-mail server.

To access the **Server** page, on the **Email** page, click the **Server** tab (see [Figure 189 on the next page](#)).

Figure 189: Server Page

Outgoing Email Server Help

No email server has been configured.

Hostname or IP Address  ?

From Email Address

Enable Admin Alerts about Email Server not configured.

**Note:** To help maintain system integrity, Quantum regularly collects system information through automatic emails. These emails contain configuration and status information only, and do not contain any customer data stored on the system.

Enable automatic status and configuration emails to Quantum.

To specify the outgoing e-mail server:

1. In the **Hostname or IP Address** box, enter the hostname or IP address of the outgoing e-mail server.

#### Additional Information

- When entering IP addresses, never use an address that is in a reserved IP address range. To see a list of reserved IP address ranges, click the quick tip icon [?] located near the IP address field.
- To use hostname format, you must specify at least one DNS IP address on the **Network** page (see [Network on page 322](#)).

2. In the **From Email Address** box, enter the return e-mail address displayed in e-mails sent by the DXi6900.

Specify a return address that lets you easily identify the system that generated the e-mail (for example, systemname@any-domain.com). The return address must contain an @ symbol and a valid domain name, including a period.

3. (Optional) Select the **Enable Admin Alerts about Email Server not configured** check box to have system generate administration alerts to notify you if an e-mail server is not configured.
4. (Recommended) Select the **Enable automatic emails to Quantum** check box to periodically send system configuration and status information to Quantum, including any software upgrades you have installed using the **Software Upgrade Utility**. Quantum Support can use this information to provide a better support experience in the future.

**i Note:** Automatic e-mails contain configuration and status information only, and do not contain any customer data stored on the system.

5. Click **Apply**.

## Test

The **Email Test** page allows you to send a test e-mail to verify that e-mail notifications are correctly configured on the DXi6900.

To access the **Email Test** page, on the **Email** page, click the **Test** tab (see [Figure 190 below](#)).

**Figure 190:** Email Test Page

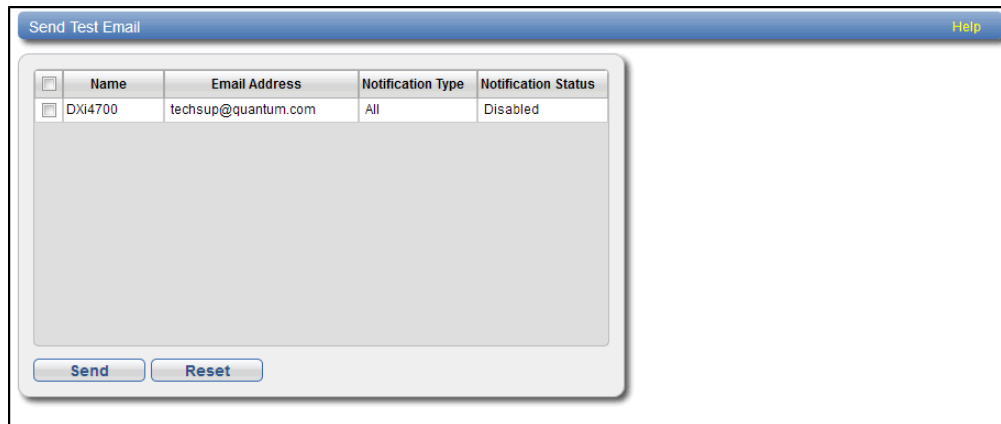

To send a test e-mail, select a recipient in the list and click **Send**. If the recipient does not receive the e-mail, make sure that the recipient's e-mail address is correct (see [Editing an E-mail Recipient on page 307](#)). Also make sure that the outgoing e-mail server is correct (see [Server on page 308](#)).

## Email Reports

The **Email Reports** page allows you to specify the e-mail recipients for automatically generated reports. You can also generate reports on demand.

The system can generate a report with system status data or with configuration data. Each report also includes the system serial number, date and time, and a message that informs the recipient that the e-mail is automated and they should not respond to it.

---

**i Note:** To enable the DXi6900 to send e-mail, you must specify an outgoing e-mail server (see [Server on page 308](#)).

To access the **Email Reports** page, on the **Email** page, click the **Email Reports** tab.

The **Email Reports** page contains the following tabs:

### Recipients

The **Recipients** page allows you to specify the e-mail recipients who will receive all scheduled status data and configuration data reports.

---

**i Note:** To configure the schedule when e-mail reports are sent, use the **Configuration > Scheduler** page (see [Scheduling E-mail Reports on page 302](#)).

To access the **Recipients** page, on the **Email Reports** page, click the **Recipients** tab (see [Figure 191 below](#)).

**Figure 191:** Recipients Page



The screenshot shows a web interface titled "Email Reports Recipients". It features a "Help" link in the top right corner. Below the title bar, there are four input fields labeled "Recipient 1", "Recipient 2", "Recipient 3", and "Recipient 4". The first field contains the email address "DXILogger.ScriptData@quantum.com". Below these fields is an "Apply" button.

Enter the e-mail addresses of up to four recipients in the boxes, and then click **Apply**. When the DXi generates scheduled e-mail reports, they will be sent to the specified addresses.

## On Demand

The **On Demand** page allows you to manually generate a status data or configuration data report. The report is immediately sent to the specified e-mail recipient. You can also view configuration data.

To access the **On Demand** page, on the **Email Reports** page, click the **On Demand** tab (see [Figure 192 below](#)).

**Figure 192:** On Demand Page

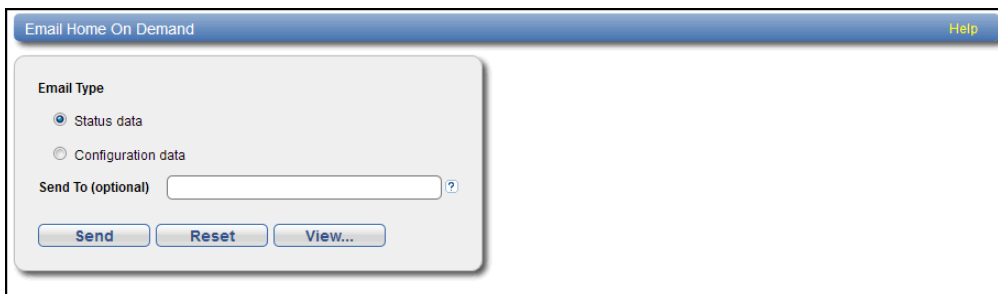

The screenshot shows a web interface titled "Email Home On Demand". It features a "Help" link in the top right corner. Below the title bar, there is a section for "Email Type" with two radio buttons: "Status data" (selected) and "Configuration data". Below this is a "Send To (optional)" input field with a question mark icon. At the bottom, there are three buttons: "Send", "Reset", and "View...".

## Tasks

Use the **On Demand** page to perform the following tasks:

Manually send a status data or configuration data report (see [Sending a Report below](#)).

View a configuration data report (see [Viewing Configuration Data on the next page](#)).

## Sending a Report

To manually send a status data or configuration data report:

1. Under **Email Type**, select the type of report to send (**Status data** or **Configuration data**).
2. In the **Send To** box, enter the e-mail address of the recipient.
3. Click **Send**.

### Viewing Configuration Data

To view a configuration data report:

1. Under **Email Type**, select **Configuration data**.
2. Click **View**.

The **System Configuration Report** window displays.

3. (Optional) Click **Save** to save a local copy of the report in TXT format.

## SNMP

The **SNMP** page allows you to configure the DXi6900 to send status messages using SNMP (Simple Network Management Protocol). The DXi6900 supports SNMP v1 and v2c.

SNMP works by sending messages, called protocol data units (PDUs), to different parts of a network, or communities. SNMP compliant devices, called agents, store data about themselves in Management Information Bases (MIBs) and return this data to the SNMP requesters.

You can configure the DXi6900 to act as an agent and send traps to a specified destination. You can also add SNMP community information.

To access a copy of the SNMP MIB file, see [SNMP MIB File](#).

To access the **SNMP** page, on the **Notifications** page, click the **SNMP** tab.

The **SNMP** page contains the following tabs:

- [Destinations below](#)
- [Community on page 316](#)
- [Test on page 321](#)

## Destinations

The **Destinations** page allows you to manage the destinations the DXi6900 sends SNMP traps to. You can add, edit, and delete SNMP destinations, and you can specify the types of traps to send.

To access the **Destinations** page, on the **SNMP** page, click the **Destinations** tab (see [Figure 193 on the next page](#)).



**Figure 193:** Destinations Page



### Tasks

Use the **Destinations** page to perform the following tasks:

- View information about SNMP destinations (see [Trap Destination List below](#)).
- Add an SNMP destination (see [Adding a Destination below](#)).
- Edit an SNMP destination (see [Editing a Destination on page 315](#)).
- Delete an SNMP destination (see [Deleting a Destination on page 316](#)).

### Trap Destination List

The **Trap Destination List** displays the following information about SNMP destinations:

<b>IP Address</b>	The IP address of the destination.
<b>Name</b>	The name of the destination.
<b>Selected Traps</b>	The traps the DXi6900 sends to the destination ( <b>Failure</b> , <b>Warning</b> , <b>Informational</b> , <b>Available</b> , or <b>Unavailable</b> ).

### Adding a Destination

Add an SNMP destination to send traps from the DXi6900 to the destination.

**Note:** You can add up to 5 destinations.

To add a destination:

1. Click **Add**.

The **Add Trap Destination** page displays (see [Figure 194 on the next page](#)).

**Figure 194:** Add Trap Destination Page

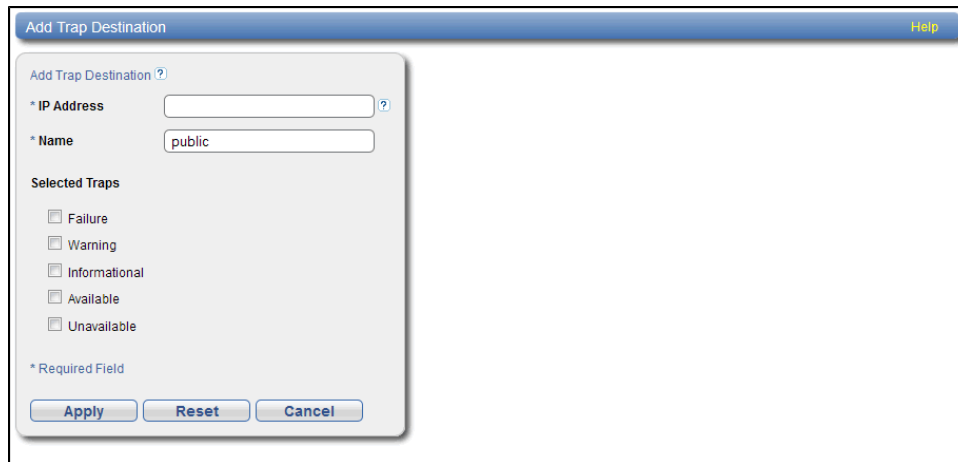

2. Enter information about the destination:

---

<b>IP Address</b>	Enter the IP address of the system that will receive the traps generated by the DXi6900.
-------------------	--

**Additional Information**

- When entering IP addresses, never use an address that is in a reserved IP address range. To see a list of reserved IP address ranges, click the quick tip icon **[?]** located near the IP address field.
- To use hostname format, you must specify at least one DNS IP address on the **Network** page (see [Network on page 322](#)).

---

<b>Name</b>	Enter the name of the destination.
-------------	------------------------------------

3. Select one or more traps to send to the destination:

---

<b>Failure</b>	Sends failure traps.
----------------	----------------------

---

<b>Warning</b>	Sends warning traps.
----------------	----------------------

---

<b>Informational</b>	Sends informational traps.
----------------------	----------------------------

---

<b>Available</b>	Sends a trap when the system transitions from an unavailable to an available state.
------------------	---

---

<b>Unavailable</b>	Sends a trap when the system transitions from an available to an unavailable state.
--------------------	---

4. Click **Apply**.

## Editing a Destination

Edit an SNMP destination to change the name of the destination or the types of traps the DXi6900 sends to the destination.

To edit a destination:

1. Click **Edit**.

The **Edit Trap Destination** page displays (see [Figure 195 below](#)).

**Figure 195:** Edit Trap Destination Page

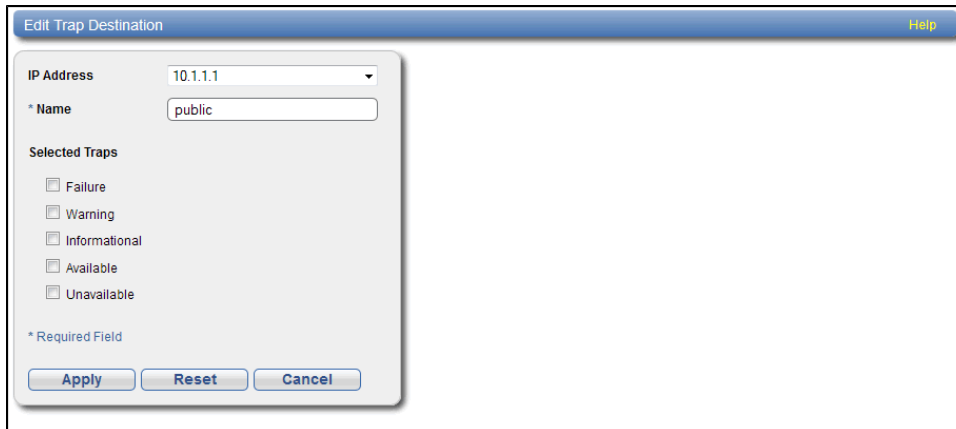

2. Enter information about the destination:

---

**i Note:** If you are editing a destination, you cannot change the **IP Address**.

---

<b>IP Address</b>	(Optional) Select a different destination to edit.
-------------------	--

---

<b>Name</b>	Enter the name of the destination.
-------------	------------------------------------

---

3. Select one or more traps to send to the destination:

<b>Failure</b>	Sends failure traps.
<b>Warning</b>	Sends warning traps.
<b>Informational</b>	Sends informational traps.
<b>Available</b>	Sends a trap when the system transitions from an unavailable to an available state.
<b>Unavailable</b>	Sends a trap when the system transitions from an available to an unavailable state.

4. Click **Apply**.

### Deleting a Destination

Delete an SNMP destination if you no longer want the DXi6900 to send traps to the destination.

To delete a destination, select the destination and click **Delete**.

**Note:** You can select multiple destinations to delete at once.

## Community

The **Community** page allows you to manage SNMP community information for the DXi6900. You can add, edit, and delete communities, and you can specify the community access type.

To access the **Community** page, on the **SNMP** page, click the **Community** tab (see [Figure 196 below](#)).

**Figure 196:** Community Page

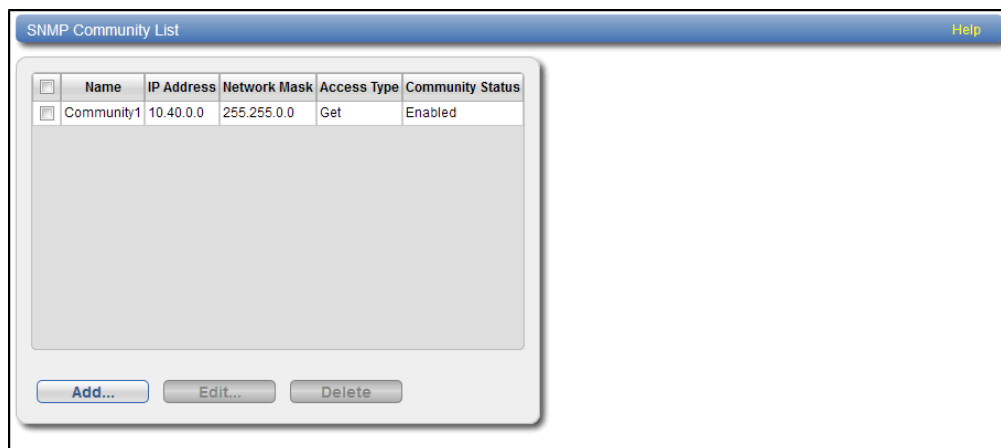

### Tasks

Use the **Community** page to perform the following tasks:

- View information about SNMP communities (see [SNMP Community List below](#)).
- Add an SNMP community (see [Adding a Community below](#)).
- Edit an SNMP community (see [Editing a Community on page 319](#)).
- Delete an SNMP community (see [Deleting a Community on page 320](#)).

## SNMP Community List

The **SNMP Community List** displays the following information about SNMP communities:

<b>Name</b>	The name of the community.
<b>IP Address</b>	The IP address of the community.
<b>Network Mask</b>	The network mask of the community.
<b>Access Type</b>	The access type of the community ( <b>Get</b> or <b>Get/Set</b> ).
<b>Community Status</b>	The status of the community ( <b>Enabled</b> or <b>Disabled</b> ).

## Adding a Community

Add an SNMP community to include the DXi6900 in a group of devices that are monitored by a common management station.

**i Note:** If no communities are defined, the SNMP agent is not accessible.

To add a community:

1. Click **Add**.

The **Add SNMP Community** page displays (see [Figure 197 on the next page](#)).

**Figure 197:** Add SNMP Community Page

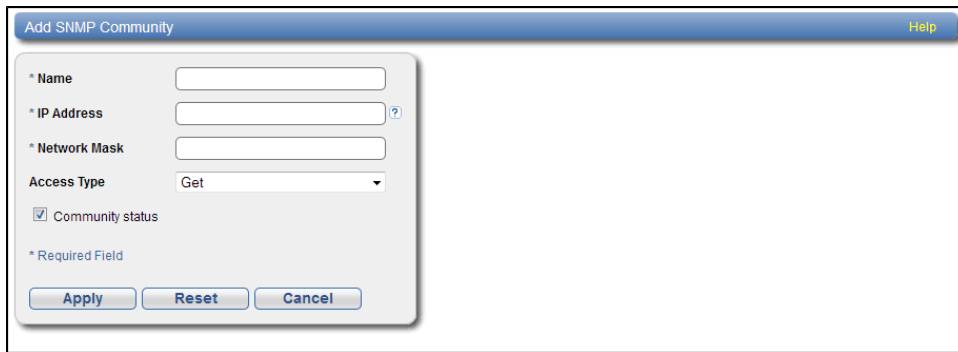

2. In the **Name** box, enter a unique **Name** for the community (up to 20 characters).  
Valid characters are letters, numbers, hyphens, and underscores.
3. Enter a valid **IP Address** and **Network Mask** pair.

A pair is valid if performing a logical bitwise **AND** operation on the IP address and the network mask results in the IP address. See the table below for examples:

IP Address / Network Mask	Result
10.40.166.87 255.255.255.255	Allows access only from 10.40.166.87
10.40.166.87 10.40.166.87	Allows access only from 10.40.166.87
10.40.166.87 10.40.166.0	Invalid because the logical bitwise operation (address <b>AND</b> mask) is not equal to the address
10.40.166.87 255.255.0.0	Invalid because the logical bitwise operation (address <b>AND</b> mask) is not equal to the address
10.40.0.0 255.255.0.0	Allows access from any client with address 10.40.xx.xx

#### Additional Information

- If you define a single community and set both the IP address and network mask to 0.0.0.0 (or leave both blank), then IP address-based access control is disabled. In this case, the SNMP

agent is accessible from any IP address.

- When entering IP addresses, never use an address that is in a reserved IP address range. To see a list of reserved IP address ranges, click the quick tip icon [?] located near the IP address field.

4. In the **Access Type** drop-down box, select the access type for the community:

<b>Get</b>	Allows SNMP get operations.
<b>Get/Set</b>	Allows both SNMP <b>get</b> and <b>put</b> operations.

5. Select the **Community status** check box to enable the community.  
Or clear the **Community status** check box to disable the community.
6. Click **Apply**.

### Editing a Community

Edit an SNMP community to change the IP address or access type for the community. You can also enable or disable the community.

To edit a community:

1. Click **Edit**.

The **Edit SNMP Community** page displays (see [Figure 198 below](#)).

**Figure 198:** Edit SNMP Community Page

The screenshot shows a dialog box titled "Edit SNMP Community" with a "Help" button in the top right corner. The dialog contains the following fields and controls:

- Name:** A dropdown menu currently showing "Community1".
- \* IP Address:** A text input field containing "10.40.0.0" with a question mark icon to its right.
- \* Network Mask:** A text input field containing "255.255.0.0".
- Access Type:** A dropdown menu currently showing "Get".
- Community status:** A checked checkbox.
- \* Required Field:** A legend indicating that fields with an asterisk are required.
- Buttons:** "Apply", "Reset", and "Cancel" buttons at the bottom.

2. (Optional) In the **Name** box, select a different community to edit.
3. Enter a valid **IP Address and Network Mask** pair.

A pair is valid if performing a logical bitwise **AND** operation on the IP address and the network mask results in the IP address. See the table below for examples:

IP Address / Network Mask	Result
10.40.166.87 255.255.255.255	Allows access only from 10.40.166.87
10.40.166.87 10.40.166.87	Allows access only from 10.40.166.87
10.40.166.87 10.40.166.0	Invalid because the logical bitwise operation (address <b>AND</b> mask) is not equal to the address
10.40.166.87 255.255.0.0	Invalid because the logical bitwise operation (address <b>AND</b> mask) is not equal to the address
10.40.0.0 255.255.0.0	Allows access from any client with address 10.40.xx.xx

#### Additional Information

- If you define a single community and set both the IP address and network mask to 0.0.0.0 (or leave both blank), then IP address-based access control is disabled. In this case, the SNMP agent is accessible from any IP address.
- When entering IP addresses, never use an address that is in a reserved IP address range. To see a list of reserved IP address ranges, click the quick tip icon **[?]** located near the IP address field.

4. In the **Access Type** drop-down box, select the access type for the community:

<b>Get</b>	Allows SNMP get operations.
<b>Get/Set</b>	Allows both SNMP <b>get</b> and <b>put</b> operations.

5. Select the **Community status** check box to enable the community.  
Or clear the **Community status** check box to disable the community.
6. Click **Apply**.

#### Deleting a Community

Delete an SNMP community if you no longer want the DXi6900 to belong to a group of devices that are monitored by a common management station.

To delete a community, select the community and click **Delete**.



**Note:** You can select multiple communities to delete at once

## Test

The **SNMP Test** page allows you to send a test SNMP trap to verify that SNMP is correctly configured on the DXi6900.

To access the **SNMP Test** page, on the **SNMP** page, click the **Test** tab (see [Figure 199 below](#)).

**Figure 199:** SNMP Test Page

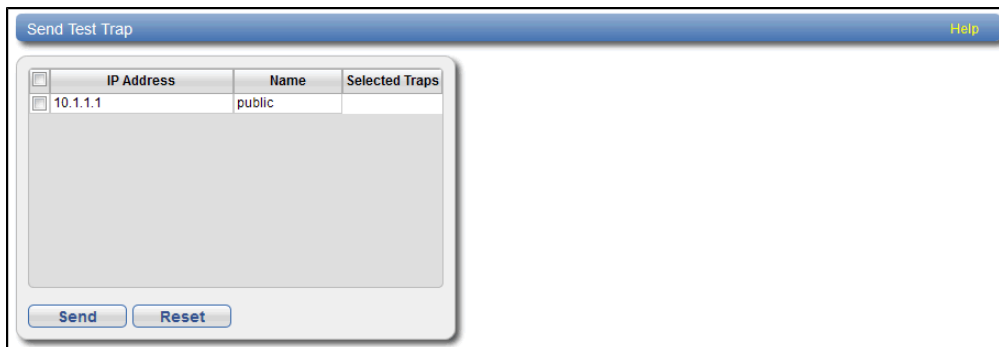

To send a test SNMP trap, select a destination in the list and click **Send**. If the destination does not receive the SNMP trap, make sure that the destination IP address is correct (see [Editing a Destination on page 315](#)). Also make sure that the community information is correct (see [Community on page 316](#)).

---

## System

To access the **System** page, click the **Configuration** menu, and then click the **System** tab.

The **System** page contains the following tabs:

- [Network on the next page](#)
- [Date & Time on page 333](#)
- [Security on page 335](#)
- [Manage Users \(DXi6900-S\) on page 357](#)
- [FC Initiators and Targets on page 362](#)
- [Client Plug-Ins \(DXi6900-S\) on page 360](#)

# Network

The **Network** page allows you to view and change network configuration information for the DXi6900. The DXi6900 uses this information to connect to the network.

Network configuration information is entered during initial setup DXi6900. You should consult your network administrator before making any changes to the network settings.

**⚠ Caution:** Changing the network configuration requires a system reboot to allow all system services to function correctly. Changing the network configuration requires a system reboot immediately after the changes are applied.

## Additional Information

Rebooting the system can take several minutes. After the new network configuration is saved, close your Web browser and wait 15 minutes before logging in again. If you change the IP address that you use to log in to the system, you will temporarily lose your connection to the remote management console. Because of this, you might not see a confirmation page informing you that the new settings have been saved.

To access the **Network** page, on the **System** page, click the **Network** tab.

## Configuring the Network

Using the **Network** page, each physical Ethernet port in the DXi can be configured as a separate device. In addition, you can create bonded devices (logical ports) consisting of two or more physical ports of the same link speed (1GbE or 10GbE). For each port or device, you can specify the MTU (Maximum Transmission Unit) frame size.

After you define devices (single port or bonded), you can create up to ten network interfaces for each device. Each interface has its own IP address information. In addition, you can configure the following options for each interface:

- Assign the interface to a VLAN (Virtual Local Area Network).
- Indicate whether the interface IP address will be used to externally identify the system (external host IP address).
- Specify the types of traffic allowed on the interface (management, replication, or data).
- Specify the NAT address that the interface is mapped to if it is used for replication through a NAT firewall.
- Add routing information for an interface to enable connectivity with devices on different subnets.

**i Note:** You can choose to allow any traffic type (management, replication, or data) on an interface. In this case, the routing of different traffic types, as well as firewall capability, must be controlled using the network infrastructure (routers and switches) that the DXi is connected to.

Configuring the network includes the following major steps:

**Note:** Before configuring the network, work with your network administrator to determine the network settings that will be required to properly integrate the DXi6900 with your company's network.

## Configuring General Network Settings

Under **General**, enter the following network information as provided by your network administrator (see [Figure 200 below](#)):

**Figure 200:** Network Page: General

General ?

\*Hostname

Default Gateway

DNS Suffix Search List

Primary DNS IP Address 

Secondary DNS IP Address

Tertiary DNS IP Address

Note: Domain Suffix Search List and DNS IP addresses cannot be changed while the DXi is joined to a Windows domain. To disjoin from the domain, go to the [Windows Domain](#) page.

\* Required Field

### Additional Information

- When entering IP addresses, never use an address that is in a reserved IP address range. To see a list of reserved IP address ranges, click the quick tip icon [?] located near the IP address field.
- The **DNS Suffix Search List** and **DNS IP Addresses** cannot be modified if the DXi6900 is currently joined to a Windows domain. To disjoin a Windows domain, see .

#### Hostname

The hostname of the DXi6900.

The **Hostname** cannot be blank and must contain only letters [ A–Z, a–z ], numbers [ 0–9 ], and hyphens [ - ].

#### Default Gateway

The default gateway IP address.

Specifying a default gateway is optional if all access is local to a particular subnet. For example, if the DXi6900 and all of its clients are on the same subnet, you do not need to specify a default gateway.



**Caution:** Specifying a default gateway is required to enable connectivity with all subnets other than those that the DXi6900 is directly connected to. For example, if the DXi6900 and its clients are on different subnets, or you are using an external NTP server, you must specify a default gateway.

**DNS Suffix Search List**

(Optional) The domain list to search when resolving domain names.

The list may be either a single domain name or a comma-separated list of up to 6 domain names. The first domain name listed is used as the local domain. Domain names must contain only letters [ A–Z, a–z ], numbers [ 0–9 ], dots [ . ], and hyphens [ - ].

**Primary, Secondary, and Tertiary DNS IP Address**

(Optional) The IP addresses of up to three DNS servers used to resolve domain names and translate them into IP addresses.

**Note:** You must specify a DNS IP address if you plan to use hostname format when configuring an NTP time server, outgoing e-mail server, replication sources and targets, and other information.

**Configuring Bonding Details**

Under **IP Address Configuration > Bonding Details**, configure bonded devices (see [Figure 201 below](#)):

**Figure 201:** Network Page: Bonding Details

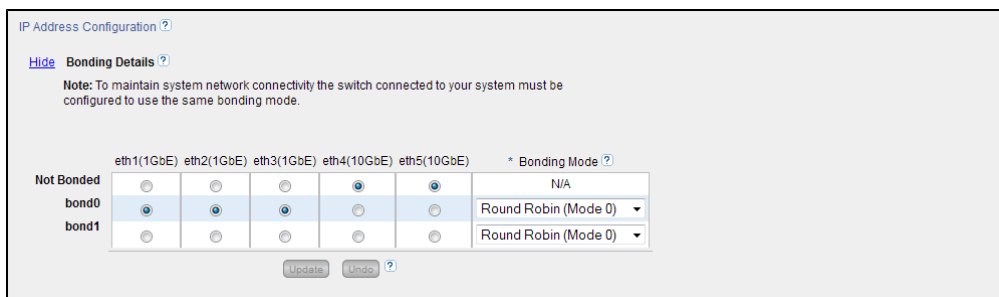

1. If necessary, click the **Show** link to show the bonding details table.
2. For each available bonded device (**bond0**, **bond1**, and so on), select two or more Ethernet ports with the same link speed to assign to the bond. Or select **Not Bonded** to leave a port unassigned to any bond.

If no ports are assigned to a bond, the bond cannot be configured. That is, settings cannot be entered for the bond in the **Interface Details** or **IP Address** tables because no Ethernet ports are assigned to the device.

All ports assigned to the same device are bonded together into a single logical port. For example, if you select **bond0** for port **eth0** and port **eth1**, both ports are bonded together in the **bond0** device. A bonded device can contain two or more ports.

All ports associated with a bond must have the same link speed (1GbE or 10GbE).

3. For each bonded device, specify the bonding mode:

**i Note:** To maintain network connectivity, the switch connected to the DXi6900 must be configured to use the same bonding mode. The best time to change the bonding mode on the switch is during the next reboot of your system, after saving the new network settings. Changing the bonding mode on the switch before saving these settings and rebooting may result in the loss of network connectivity to the system.

Bonding Mode	Description
<b>Round Robin (Mode 0)</b>	This option sends Ethernet frames using the bonded Ethernet ports with a valid MII link. Frames are sent in a round-robin fashion, starting with the first slave device and then the rest of the devices. This only applies to the traffic sent from the DXi6900. The Ethernet switch needs to aggregate the ports, so the connected ports are treated as a logical port. The DXi frame reception is completely dependent on the transmission algorithm of the Ethernet switch. The bonding mechanism does not balance the frame reception.
<b>LACP (Mode 4)</b>	This option (Link Aggregation Control Protocol) is based on the 802.3ad IEEE standard for aggregating Ethernet ports. If the bonding algorithm is set to LACP, the Ethernet switch ports must be configured in a 802.3ad based Link Aggregation group (LAG) in LACP mode. The DXi frame reception and transmission is controlled by the LACP between the bonded ports and the Ethernet switch ports.
<b>Active Backup (Mode 1)</b>	This option does not require switch configuration but may not provide the same level of load balancing and performance as other bonding modes. Only one port in the bond is active at a time. If the active port fails, another port becomes active to take its place. Because only the MAC address of the active port is visible to the Ethernet switch, the switch does not require additional configuration.

4. Click **Update** to save the changes you made to the **Bonding Details** table. (Clicking **Update** does not yet apply the new network settings to the DXi6900.)
5. Click **Undo** to revert to all current Bonding Details changes to the last update.

### Configuring Interface Details

Under **IP Address Configuration > Interface Details**, configure jumbo Ethernet frame settings for each port or device (see [Figure 202 on the next page](#)):

**Figure 202:** Network Page: Interface Details

Jumbo Frame						
Physical Ports	Bonding Mode	Link Speed	Link Status	Carrier Status	MTU Size	
eth4	N/A	10GbE	Down	No Carrier	1500	
eth5	N/A	10GbE	Down	No Carrier	1500	
bond0	eth1,eth2,eth3 Round Robin (Mode 0)	1GbE	Up	Up	1500	

1. If necessary, click the **Show** link to show the interface details table.
2. For each device, select the MTU (Maximum Transmission Unit) frame size in the **Jumbo Frame MTU Size** drop-down box.

---

**1500 MTU** (Default) The standard (STD) MTU frame size of 1,500 bytes is used.

---

**9000 MTU** The jumbo MTU frame size of 9,000 bytes is used. (For best performance, make sure the entire network path to the DXi is configured to use 9000 MTU.)

---

3. Click **Update** to save the changes you made to the **Interface Details** table. (Clicking **Update** does not yet apply the new network settings to the DXi6900.)
4. Click **Undo** to revert to all current Interface Details changes to the last update.

### Configuring Interface IP Addresses

Under **IP Address Configuration > IP Address Table**, configure one or more network interfaces for each port or device (physical Ethernet port or bonded device) (see [Figure 203 below](#)):

**Figure 203:** Network Page: IP Address Table

Note: A maximum of 10 IP addresses per interface are allowed.  
If replication is performed across public network with source and target DXi behind NAT routers, you must configure this DXi's NAT IP Address.

IP Config	External						Replication NAT IP Config		Traffic Type Allowed				
	Type	Interface	VLAN ID	Host IP	* IP Address	* Netmask	* Gateway	NATed	NAT IP Address	Mgmt	Repl	Data	Any
eth4	Static	<input type="button" value="Add IP"/>											
eth5	Static	<input type="button" value="Add IP"/>											
bond0	Static	<input checked="" type="radio"/> bond0:2	<input type="text" value=""/>	<input checked="" type="checkbox"/>	<input type="text" value="10.10.10.10"/>	<input type="text" value="255.255.255.0"/>	<input type="text" value="10.10.10.1"/>	<input type="checkbox"/>	<input type="text" value=""/>	<input type="checkbox"/>	<input type="checkbox"/>	<input type="checkbox"/>	<input checked="" type="checkbox"/>

1. Click **Add IP** to add a network interface to a device.  
Or select an interface to edit the IP address, netmask, gateway and traffic type. (To select an interface, click the radio button next to the interface index name, for example, **bond0:2**.)

**i Note:** A maximum of 10 IP addresses are allowed per device. All IP addresses in the IP Address Table (added or modified) must be valid and unique, and must have a valid gateway and netmask.

2. In the **VLAN ID** column, select the check box to enable VLAN tagging for the interface. (Or clear the check box to disable VLAN tagging for the interface.)

VLAN tagging allows you to assign an interface to a virtual local area network (VLAN). With VLAN tagging, you can route different traffic types (management, data, and replication) over different VLANs, making sure traffic types do not mix.

If VLAN tagging is enabled, enter the **VLAN Tag ID** for the interface. (Valid values are **2** to **4094**. You can assign only one tag ID to an interface.)

#### Additional Information

- The maximum allowed number of VLAN tag IDs is 64. If you attempt to add more than 64 VLAN tag IDs, an error displays.
- To maintain connectivity, the switch ports connected to the DXi must be configured to accept the correct VLAN tag ID.

**! Caution:** If VLAN tagging is enabled for an interface, DXi Advanced Reporting is unable to collect and record statistics for traffic moving over the VLAN interface (for example, eth1.400). Statistics are still collected for the base device (for example, eth1.)

3. In the **External Host IP** column, select the check box to designate the interface as an external host IP. This associates the interface IP address with the host name of the DXi, and the DXi is externally identified by the host IP. The following restrictions apply:
  - You can designate only one external host IP for the network configuration.
  - You must specify a traffic type of **Mgmt** (management) or **Any** for the external host IP interface.
  - You must specify a valid **Default Gateway** in the **General** section. In addition, the external host IP must be on the same subnet as the **Default Gateway** to ensure external communication.
4. Enter the following network information as provided by your network administrator (all fields are required):

<b>IP Address</b>	The IP address of the interface.
<b>Netmask</b>	The network mask of the interface.
<b>Gateway</b>	The gateway of the DXi6900. (This is usually not the same as the default gateway.)

5. If necessary, specify NAT (Network Address Translation) settings for the interface:

**i Note:** If the DXi6900 is a replication target and is behind a NAT router, you *must* configure a NAT IP Address

<b>NATed</b>	Select the check box if the IP address of the DXi is translated by a firewall to a NAT IP address when the DXi communicates to the outside world.
<b>NAT IP Address</b>	The IP address used to access the DXi from the public network. The router that connects the DXi to the Internet performs Network Address Translation that maps the IP address of the DXi to the NAT IP address, providing a valid replication interface for a source DXi.

6. Select the check box for each type of network traffic allowed on the interface (segmentation):  
At least one interface must allow management traffic.

<b>Mgmt</b>	Select to allow management traffic.
<b>Repl</b>	Select to allow replication traffic.
<b>Data</b>	Select to allow data traffic.
<b>Any</b>	Select to allow all types of traffic (management, replication, and data).

#### Additional Information

- At least one interface must allow management traffic.
- If the DXi is configured for source or target replication, you should configure at least one interface to allow replication traffic (select **Repl** or **Any**) before applying changes to network settings.
- If you configure segmentation for non-bonded interfaces (Ethernet ports) that are on the same subnet, all traffic will use the lowest numbered Ethernet port first, no matter how segmentation is configured. To avoid this issue, create bonded interfaces, and then select the desired traffic type for each bonded interface.

7. Click **Update** to save the changes you made to the **IP Address** table. (Clicking **Update** does not yet apply the new network settings to the DXi6900.)
8. Click **Delete** to remove IP address information for the selected interface. Or click **Undo** to revert all current IP Address Table changes to the last update.



**Note:** When you add a network interface, a default route (via the default gateway) is automatically created for the interface after network settings are applied and the DXi reboots. For example, if you add an interface with IP address 10.20.185.172, a route with the destination IP address 10.20.185.0 is automatically added. If you delete the default route, it is automatically added again the next time network settings are applied and the DXi reboots. For more information about interface routing, see [Network on page 322](#).

## Configuring Interface Routing

Some network configurations require that you specify routing details for an interface. You need to specify routing details if the host or client the interface connects to is on a different subnet that is not reachable using the default gateway. You also need to specify routing details if you have configured multiple network segments (replication, data, or management) on the same subnet. For more information and examples, see [Network on page 322](#).

Under **IP Address Configuration > Routing Details**, enter routing information for one or more interfaces (see [Figure 204 below](#)):

**Figure 204:** Network Page: Routing Details

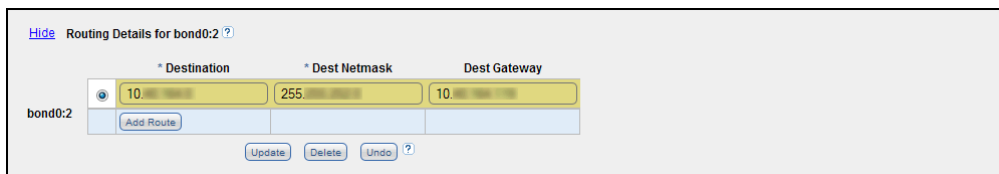

1. In the **IP Address Table** (above routing details), select an interface to add or modify routing data. (To select an interface, click the radio button next to the interface index name, for example, **bond0:2**.)

After selecting an interface in the **IP Address Table**, the **Routing Details** table below expands to display available routes (if any).

**Note:** A maximum of 8 routes per interface are allowed.

2. If necessary, click the **Show** link to show the routing details table.
3. Click **Add Route** to add a route to the selected interface.  
Or select a route to edit its settings.
4. Enter the following network information as provided by your network administrator:

<b>Destination</b>	The destination network for the route.
<b>Dest Netmask</b>	The network mask for the route.
<b>Dest Gateway</b>	The gateway IP address used for <i>outgoing</i> traffic sent from the interface to a host or client. (This is usually not the same as the default gateway.)

### Additional Information

- The destination gateway of each route *must* match the subnet of at least one configured IP address listed in the **IP Address Table**. If no match is found, an error displays stating that the route's destination gateway is not reachable.
- In the example shown below, to reach a host on the 10.50.50.x subnet, you would enter 10.50.50.0 for destination network, 255.255.255.0 for the destination netmask, and 10.20.20.1 as the destination gateway.

5. Click **Update** to save the changes you made to the **Routing Details** table. (Clicking **Update** does not yet apply the new network settings to the DXi6900.)
6. Click **Delete** to remove IP routing information for the selected interface. Or click **Undo** to revert all current Routing Details changes to the last update.

### Applying Network Settings

For network changes to take effect, you must apply the changes, finalize the confirmation, and reboot the system. To apply all changed settings on the **Network** page to the DXi6900, click **Apply** at the bottom of the page. Follow the prompts to confirm the changes and reboot the system.

**i Note:** To revert all network settings to the initial state and undo all changes, click the **Reset** button.

## Understanding Interface Routing

For a network on the interface to communicate with a host located on a different subnet, you must specify routing information in the **Routing Details** section. Routing is used to direct outgoing traffic from a network interface on the DXi to an IP address in another subnet by means of a destination gateway. Responses from the destination are routed back to the DXi using the gateway specified for the interface in the **IP Address Table** section.

In addition, when configuring segmented network interfaces, if the source DXi replication, data, and management interfaces are on the same subnet, you must add a host route on the source DXi to make sure the replication interface is correctly selected when replicating data to the target DXi.

See the following examples for details:

### Example 1: Segments and Target on Different Subnets

In the example below (see [on page 322](#)), the DXi has two segmented interfaces, one for management traffic and one for data traffic:

- The management interface is assigned to the 10.30.24.x subnet in the **IP Address Table** section. This subnet connects to the corporate network by mean of the default gateway (10.30.24.1).
- The data interface is assigned to the 10.20.20.x subnet in the **IP Address Table** section. This subnet connects to a gateway at 10.20.20.1.
- Using the data interface, the DXi needs to connect to a backup host that is on the 10.50.50.x subnet.

Because this host is not on the same subnet as the data interface, the DXi cannot communicate with the host unless you specify routing information in the **Routing Details** section.

In this example, you would specify 10.50.50.0 for destination network, 255.255.255.0 for the destination netmask, and 10.20.20.1 as the destination gateway.

---

**i Note:** The gateway specified in the **IP Address Table** section is for *incoming* traffic to the interface. The gateway specified in the **Routing Details** section is for *outgoing* traffic from the interface.

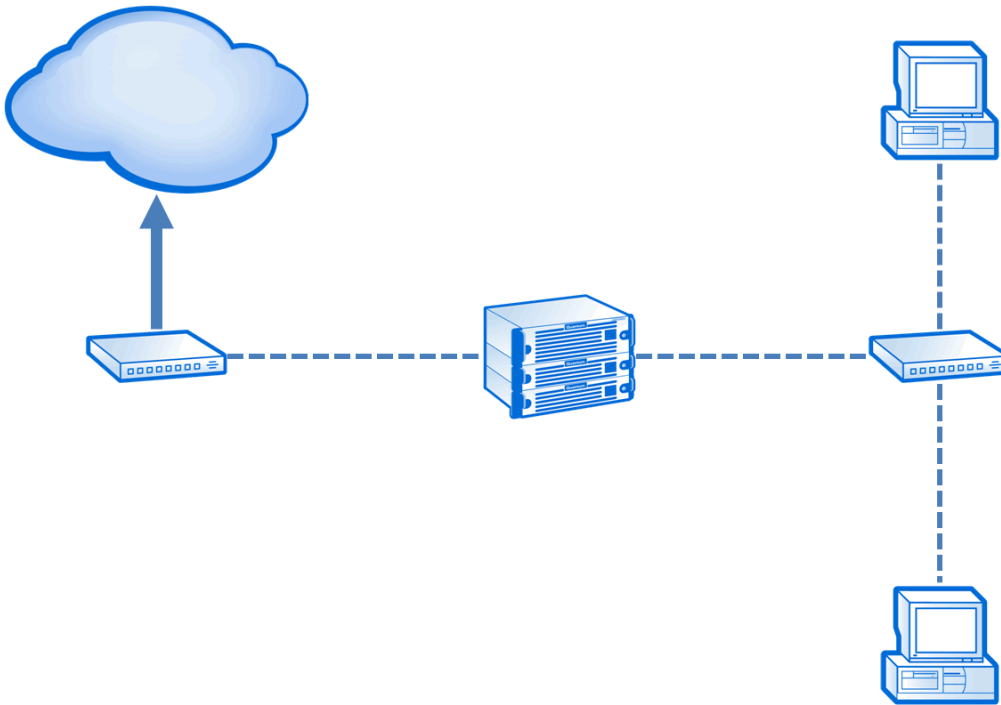

### Example 2: Segments and Target on the Same Subnet

In the example below (see [on page 322](#)), the DXi has two segmented interfaces, one for data and management traffic, and one for replication traffic:

- The source DXi management/data IP address, the source DXi replication IP address, and the target DXi IP address are all on the same subnet (192.168.10.x).
- To make sure the replication segment is used when communicating with the target DXi, you must add a host route in the **Routing Details** section on the source DXi.

In this example, you would specify the following routing details for the replication interface on the source DXi:

---

<b>Destination</b>	Use the IP address of the target DXi (192.168.10.200).
--------------------	--

---

---

<b>Dest Netmask</b>	Use 255.255.255.255.
---------------------	----------------------

---

<b>Dest Gateway</b>	Use the replication IP address of the source DXi (192.168.10.100).
---------------------	--

---



### Example 3: Segments on the Same Subnet and Target on a Different Subnet

In the example below (see [on page 322](#)), the DXi has two segmented interfaces, one for data and management traffic, and one for replication traffic:

- The source DXi management/data IP address and the source DXi replication IP address are on the same subnet (192.168.10.x). The target DXi IP address is on a different subnet (192.168.20.x)
- To make sure the replication segment is used when communicating with the target DXi, you must add a network route in the **Routing Details** section on the source DXi.

In this example, you would specify the following routing details for the replication interface on the source DXi:

---

<b>Destination</b>	Use the subnet of the target DXi (192.168.20.0).
--------------------	--

---

<b>Dest Netmask</b>	Use 255.255.255.0.
---------------------	--------------------

---

<b>Dest Gateway</b>	Use the IP address of the gateway (192.168.10.1).
---------------------	---

---

- In addition, to enable communication with the target DXi by means of the gateway, you must add a second host route in the **Routing Details** section on the source DXi.

In this example, you would specify a second set of routing details for the replication interface on the source DXi:

---

<b>Destination</b>	Use the IP address of the gateway (192.168.10.1).
--------------------	---

---

<b>Dest Netmask</b>	Use 255.255.255.255.
---------------------	----------------------

---

<b>Dest Gateway</b>	Use the replication IP address of the source DXi (192.168.10.100).
---------------------	--

---



## Backpanel Locations

The **Backpanel Locations** section at the bottom of the **Network** page displays a graphical representation of the Ethernet ports as they appear on the rear of the system (see [Figure 205 below](#) and [Figure 206 below](#)).

The diagram indicates the current bonding configuration and connectivity status for all Ethernet ports.

- Ports that are bonded together in an interface are shaded the same color.
- A green border indicates a port is connected to a network.
- A red border indicates a port is configured but is not connected to a network.
- Click **Update Port View** to update the information on the diagram.

**Figure 205:** DXi6900 G1 Network Page: Backpanel Locations

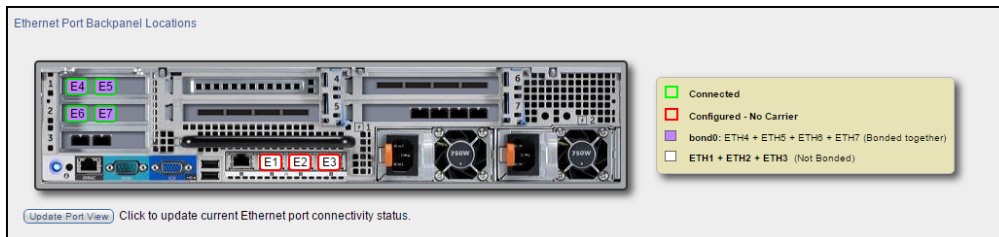

**Figure 206:** DXi6900 G2 / DXi6900-S Network Page: Backpanel Locations

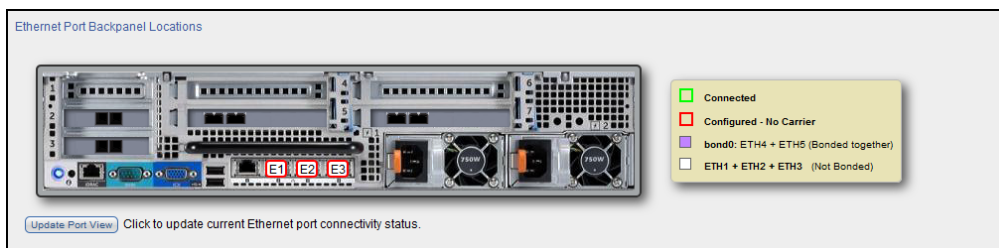

## Date & Time

The **Date & Time** page allows you to set the system date and time of the DXi6900. You can specify a Network Time Protocol (NTP) server to synchronize the system time with, or you can manually enter the date and time.

**⚠ Caution:** Changing the date and time settings requires a system reboot immediately after the changes are applied. Wait for at least 15 minutes before logging back in.

### Additional Information

- Network Time Protocol (NTP) requires a continuous connection to an NTP server to maintain the correct time. If the system does not have connectivity access, it is recommended that you set the system date and time manually.
- It is recommended that you do not modify the system date and time while making other configuration changes, such as add and removing NAS file shares.
- If you intend to join the DXi6900 to a Windows network using Active Directory for NAS storage, Quantum recommends using an NTP Server to set the system date and time (see [Windows Domain on page 223](#)).

To access the **Date & Time** page, on the **System** page, click the **Date & Time** tab (see [Figure 207 below](#)).

**Figure 207:** Date & Time Page

System Date and Time Settings Help

Network Time Protocol (NTP) Server (Recommended) ?  Manual Date & Time Settings

Select a Timeserver Pool  Specify a Timeserver or Pool

north-america.pool.ntp.org

Test NTP

Timezone: America/Los\_Angeles

Time Format:  24 Hours  12 Hours

Apply Reset

To set the system date and time:

1. Select one of the following options:

Option	Description
<b>Network Time Protocol (NTP) Server</b>	<p>(Recommended) Select this option to synchronize the DXi6900 with an NTP timeserver or pool. Then select or specify a timeserver or pool.</p> <ul style="list-style-type: none"><li>• <b>Select a Timeserver Pool</b> - (Recommended) Select one of the well-known, geographically-based NTP timeserver pools in the drop-down box.<ul style="list-style-type: none"><li>• <b>Note:</b> To select a timeserver pool, you must first specify at least one DNS IP address on the <b>Network</b> page (see <a href="#">Network on page 322</a>). Otherwise, you must specify the IP address of the timeserver pool.</li></ul></li><li>• <b>Specify a Timeserver or Pool</b> - Type the name or IP address of the NTP server or pool. (See <a href="http://support.ntp.org">http://support.ntp.org</a> for information about publicly available NTP servers)</li></ul> <p>To verify that the DXi6900 can communicate with the NTP server or pool, click <b>Test NTP</b>.</p>
<b>Manual Date &amp; Time Settings</b>	<p>Select this option to manually set the system date and time.</p> <p>Specify the <b>New System Date</b> by clicking the calendar icon. Specify the <b>New System Time</b> using the drop-down boxes.</p>

2. In the **Timezone** drop-down box, select the time zone where the DXi6900 is located.
3. Next to **Time Format**, select the format to use when displaying times (**24 hours** or **12 hours**).
4. Click **Apply**.

## Security

The **Security** page allows you to configure security settings for the DXi6900, including access passwords, SSL settings, and the inactivity timeout.

To access the **Security** page, click the **Configuration** menu, and then click the **Security** tab.

The **Security** page contains the following tabs:

### Access Control

The **Access Control Settings** page allows you to change the account passwords for the remote

management console (GUI) and the command line interface (CLI)

### Access Control Levels

The DXi6900 has the following access levels for logging onto the remote management console or the GUI:

Access Level	Description
<b>Graphical User Interface (GUI)</b>	
<b>GUI Administrator</b>	Allowed to view and change information on the DXi6900 remote management console.
<b>GUI Monitor</b>	Allowed to view information on the DXi6900 remote management console but cannot make changes. The <b>Access Control</b> page is view only.
<b>GUI Service</b>	Allowed to view and change information on the DXi6900 GUI. The <b>Access Control</b> page is view only.
<b>Command Line Interface (CLI)</b>	
<b>Viewer</b>	Allowed to view information on the DXi6900 CLI but cannot make changes.
<b>Administrator</b>	Allowed to view and change information on the DXi6900 CLI.
<b>Service Login</b>	
<b>SSH Service</b>	Allow Secure Shell (SSH) remote access to the ServiceLogin account.

To access the **Access Control Settings** page, on the **Security** page, click the **Access Control** tab (see [Figure 208 on the next page](#)).



Figure 208: Access Control Settings Page

The screenshot displays the 'Access Control Settings' page with a 'Help' link in the top right corner. The page is organized into six panels:

- GUI Administrator:** Includes fields for \* Old Password, \* New Password, and \* Confirm New Password. A \* Required Field label is present. An 'Apply' button is at the bottom.
- GUI Monitor:** Features a checkbox for 'Enable GUI Monitor Login', \* New Password, and \* Confirm New Password fields. A \* Required Field label is present. An 'Apply' button is at the bottom.
- CLI Administrator:** Has a checkbox for 'Enable CLI Administrator Login'. Below it, 'Available SSH Public Keys' are listed with 'Add...', 'Edit...', and 'Delete...' buttons. A message states 'No ssh keys have yet been configured for this account.' There is a checkbox for 'Allow login with password', \* New Password, and \* Confirm New Password fields. A \* Required Field label is present. An 'Apply' button is at the bottom.
- CLI Viewer:** Similar to CLI Administrator, with a checkbox for 'Enable CLI Viewer Login'. The 'Available SSH Public Keys' table contains one entry:

<input type="checkbox"/>	Alias	Fingerprint
<input type="checkbox"/>	Sample	62:aa:ad:5d:fa:74:36:61:22:b5 ...

There is a checkbox for 'Allow login with password', \* New Password, and \* Confirm New Password fields. A \* Required Field label is present. An 'Apply' button is at the bottom.
- GUI Service:** Features a checked checkbox for 'Enable GUI Service Login', \* New Password, and \* Confirm New Password fields. A \* Required Field label is present. An 'Apply' button is at the bottom.
- SSH Service:** Features a checked checkbox for 'Enable SSH Service Login'. Below it, 'Available SSH Public Keys' are listed with 'Add...', 'Edit...', and 'Delete...' buttons. A message states 'No ssh keys have yet been configured for this account.'

## Tasks

Use the **Access Control Settings** page to perform the following tasks:

- Change the administrator password (see [Changing GUI Administrator Password on the next page](#)).
- Enable or disable GUI access for the monitor account (see [Enabling GUI Monitor Account on the next page](#)).
- Enable or disable CLI access for the administrator or viewer account (see [Enabling CLI Accounts on page 339](#)).

- Enable or disable GUI access for the service account ([Enabling GUI Service Account on page 343](#)).
- Enable or disable SSH access for the service account ([Enabling SSH Service Account on page 343](#)).

### Changing GUI Administrator Password

Use the GUI password when logging onto the remote management console as an administrator (see [Accessing Remote Management on page 65](#)).

1. Under **GUI Administrator** enter the following information:

<b>Old Password</b>	Enter the old password.
<b>New Password</b>	Enter the new password.
<b>Confirm New Password</b>	Enter the new password again to confirm it.

#### Additional Information

- Passwords can be up to 32 characters. Alphanumeric characters and special characters are allowed.
- Loss of this password will require Quantum service support.

2. Click **Apply**.

### Enabling GUI Monitor Account

Use the GUI password when logging onto the remote management console as a monitor (see [Accessing Remote Management on page 65](#)).

1. Under **GUI Monitor** do one of the following steps:
  - Select the **Enable GUI Monitor Login** check box to enable the GUI monitor account.
  - Clear the **Enable GUI Monitor Login** check box to disable the GUI monitor account.
2. Enter the following information:

<b>New Password</b>	Enter the new password.
<b>Confirm New Password</b>	Enter the new password again to confirm it.

#### Additional Information

Passwords can be up to 32 characters. Alphanumeric characters and special characters are allowed.

3. Click **Apply**.

## Enabling CLI Accounts

The CLI accounts provide access to the DXi6900 command line interface as an administrator or viewer.

**i Note:** For more information about using the CLI, see the *DXi6900 Command Line Interface (CLI) Guide*.

1. Under **CLI Administrator** or **CLI Viewer**, do one of the following steps:
  - Select the **Enable CLI Administrator Login** or **Enable CLI View Login** check box to enable the CLI administrator or viewer account
  - Clear the **Enable CLI Administrator Login** or **Enable CLI View Login** check box to disable the CLI administrator or viewer account
2. The CLI administrator and view accounts may be configured with Secure Shell (SSH) key-based authentication.

### Add a SSH Public Key

- a. Click **Add**.

The **Add Public Key** page displays (see [Figure 209 below](#)).

**Figure 209:** Add Public Key Page

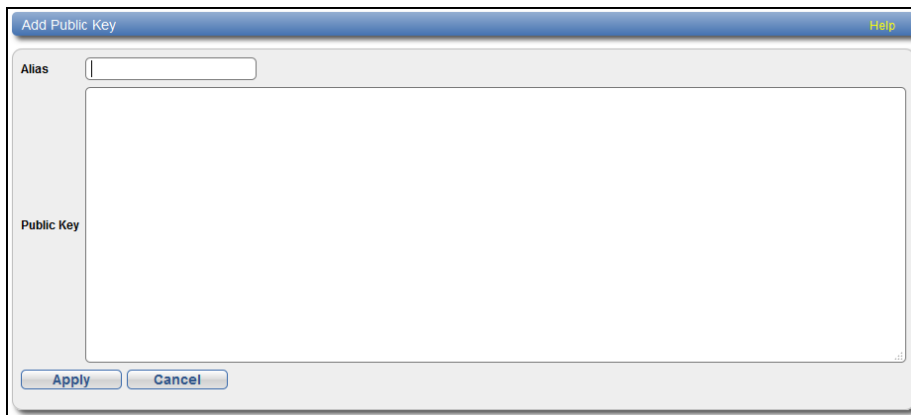

The screenshot shows a window titled "Add Public Key" with a "Help" button in the top right corner. The window contains two main input areas: a text box labeled "Alias" and a larger text area labeled "Public Key". At the bottom of the window, there are two buttons: "Apply" and "Cancel".

- b. Enter an SSH **Alias** for the public key.

### Additional Information

- An alias can be up to 20 characters.
- Alias must be an alphanumeric string (no spaces or special characters).
- It is OK to have the same alias for different accounts (CLI Administrator and CLI Viewer).

- c. Copy and paste the **Public Key** generated from a SSH key.

### Additional Information

- A public key should be in the following form: <key-type> <base64 encoded string> (see [Figure 210 below](#)).
- A public key length can be up to 16kb.

**Figure 210:** Sample Public Key Page



The screenshot shows a web form with two main sections: 'Alias' and 'Public Key'. The 'Alias' field contains the text 'Sample'. The 'Public Key' field contains a long base64 encoded string starting with 'ssh-rsa'. At the bottom of the form are two buttons: 'Apply' and 'Cancel'.

```
ssh-rsa
AAAAAB3NzaC1yc2EAAAABJQAAAQBNAm0JTmezNUDKYvEeIRf2YnwM9/uUG1d0BYsc8/tRtx+RG17N21Ubp728MXGwdnL9od4c
Itzky/zVdLZE2cyc0a18xBK9c0WmckS0A8FYBxEQWJ/q9YVUgZbFKFYGaGQxsER+A0w/fX8ALuk78ktP31K69LcQgxIs17rNz
xso0QKJ/CIx0GHMxczYTIEoLvQhapFQMs3FL96didKr/QbrfB1wT6s38385EaXfgZvLef1YB2xmfbhT90XFE3Fvvh2UPBfN+f
E7i1ayQf/2XR+8j4N4bw30DiPtOQLGUrH1y5X/rpNZN1wN2+jGIxqZtgWg71Ty3mXy5x836Sj/6L
```

- d. Click **Apply**.

The "Successfully performed Security action" message appears.

- e. Click **OK**.

The new key appears in the CLI Administrator or View **Available SSH Public Keys** table (see [Figure 211 on the next page](#)).

Figure 211: Available SSH Public Keys Table

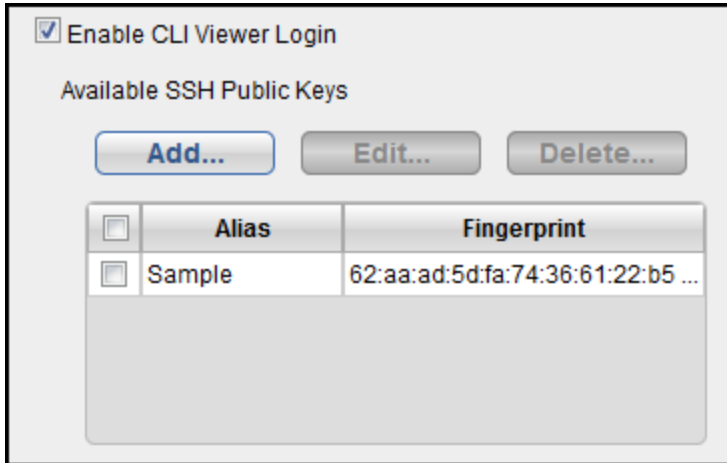

The **Available SSH Public Keys** table contains the following information:

<b>Alias</b>	Name of key.
<b>Fingerprint</b>	Short sequence of bytes used to identify a public key.

### Edit a SSH Public Key

- Select the check box next to the public key in the **Available SSH Public Keys** table.
- Click **Edit**.

The **Edit Public Key** page displays (see [Figure 212 below](#)).

Figure 212: Edit Public Key Page

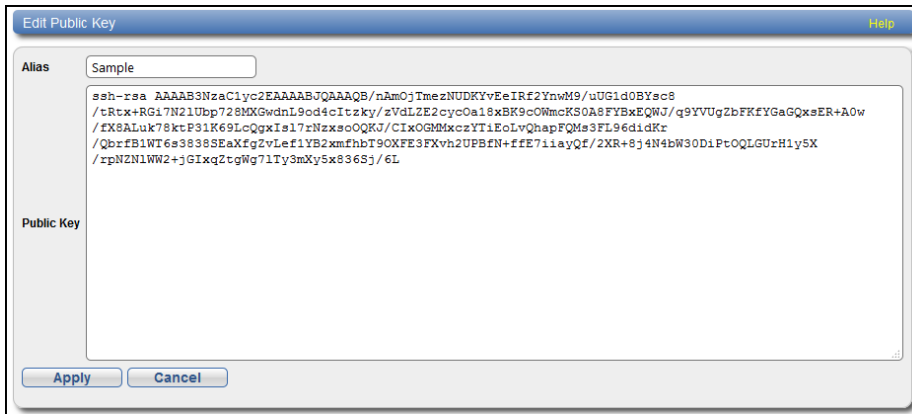

- c. Edit the **Alias** name.

**i Note:** The key cannot be modified. To remove a key, see [Delete an Alias Name below](#).

- d. Click **Apply**.

The "Successfully performed Security action" message appears.

- e. Click **OK**.

The updated key appears in the **Available SSH Public Keys** table.

### Delete an Alias Name

- a. Select the check box next to the public key in the **Available SSH Public Keys** table.

- b. Click **Delete**.

The **Delete Public Key** page displays (see [Figure 213 below](#)).

**Figure 213:** Delete Public Key Page



- c. Click **Yes**.

The "Successfully performed Security action" message appears.

- d. Click **OK**.

The key is removed in the **Available SSH Public Keys** table.

3. In addition to configuring SSH authentication, the CLI Administrator and view accounts may also be configured with password authentication.
- Select the **Allow login with password** check box to enable a password on a CLI Administrator or CLI Viewer account
  - Clear the **Allow login with password** check box to disable a password on a CLI Administrator or CLI Viewer account

Enter the following information:

---

<b>New Password</b>	Enter the new password.
<b>Confirm New Password</b>	Enter the new password again to confirm it.

---

### Additional Information

- Passwords can be up to 32 characters. Alphanumeric characters and special characters are allowed.
- For accounts enabled with both SSH and password authentication, the DXi system will first attempt SSH authentication . If there are no keys defined or no client key matches, the DXi system will fall back to password authentication.

4. Click **Apply**.

### Enabling GUI Service Account

Use the GUI password when logging onto the remote management console as a service account (see [Accessing Remote Management on page 65](#)).

To enable or disable the GUI service account:

1. Under **GUI Service** do one of the following steps:
  - Select the **Enable GUI Service Login** check box to enable the GUI service account.
  - Clear the **Enable GUI Service Login** check box to disable the GUI service account.
2. Enter the following information:

<b>New Password</b>	Enter the new password.
<b>Confirm New Password</b>	Enter the new password again to confirm it.

### Additional Information

- Passwords can be up to 32 characters. Alphanumeric characters and special characters are allowed.

3. Click **Apply**.

### Enabling SSH Service Account

The SSH service account provides SSH remote access to the DXi6900 system.

1. Under **SSH Service**, do one of the following steps:
  - Select the **Enable SSH Service Login** check box to enable SSH service account
  - Clear the **Enable SSH Service Login** check box to disable the SSH service account
2. The SSH service account may be configured with Secure Shell (SSH) key-based authentication.

#### Add a SSH Public Key

- a. Click **Add**.

The **Add Public Key** page displays (see [Figure 214 below](#)).

**Figure 214:** Add Public Key Page

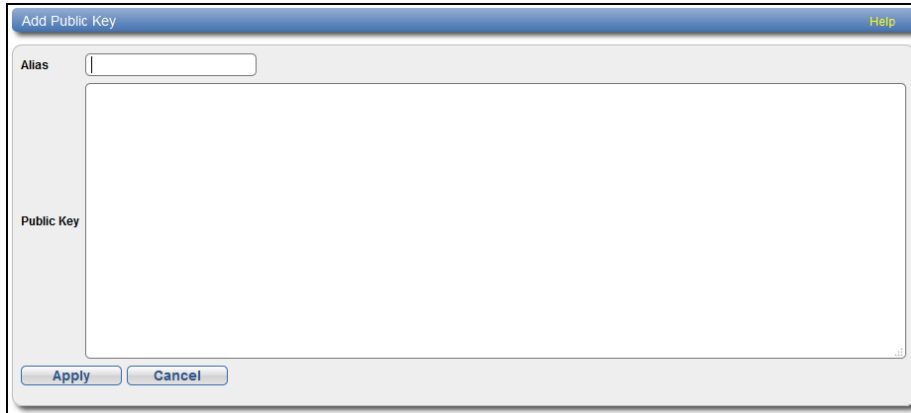

The screenshot shows a dialog box titled "Add Public Key". At the top right of the title bar is a "Help" button. Below the title bar, there is a text input field labeled "Alias". Below that is a large text area labeled "Public Key". At the bottom of the dialog, there are two buttons: "Apply" and "Cancel".

- b. Enter an SSH **Alias** for the public key.

#### **Additional Information**

- An alias can be up to 20 characters.
- Alias must be an alphanumeric string (no spaces or special characters)..

- c. Enter the **Public Key** generated from a SSH key.

#### **Additional Information**

- A public key should be in the following form: <key-type> <base64 encoded string> (see [Figure 215 on the next page](#)).
- A public key length can be up to 16kb.



**Figure 215:** Sample Public Key Page

Alias: Sample

```
ssh-rsa
AAAAAB3NzaC1yc2EAAAABJQAAAQBNAm0JTmezNUDKYvEeIRf2YnwM9/uUG1d0BYsc8/tRtx+RG17N21Ubp728MXGwdnL9od4c
Itzky/zVdLZE2cyc0a18xBK9c0WmckS0A8FYBxEQWJ/q9YVUgZbFKFYGaGQxsER+A0w/fX8ALuk78ktP31K69LcQgxIs17rNz
xso0QKJ/CIx0GHIxzcYTIEoLvQhapFQMs3FL96didKr/QbrfB1Wt6s38385EaXfgZvLef1YB2xmfbhT90XFE3FXvh2UPBFN+f
FE7iIayQf/2XR+8j4N4bw30DiPtOQLGUrH1y5X/rpNZN1wN2+jGIxqZtgWg71Ty3mXy5x836Sj/6L
```

Public Key

Apply Cancel

d. Click **Apply**.

The "Successfully performed Security action" message appears.

e. Click **OK**.

The new key appears in the **Available SSH Public Keys** table (see [Figure 216 below](#)).

**Figure 216:** Available SSH Public Keys Table

Enable SSH Service Login

Available SSH Public Keys

Add... Edit... Delete...

No ssh keys have yet been configured for this account.

The **Available SSH Public Keys** table contains the following information:

<b>Alias</b>	Name of key.
<b>Fingerprint</b>	Short sequence of bytes used to identify a public key.

### Edit a SSH Public Key

- a. Select the check box next to the public key in the **Available SSH Public Keys** table.
- b. Click **Edit**.

The **Edit Public Key** page displays (see [Figure 217 below](#)).

**Figure 217:** Edit Public Key Page

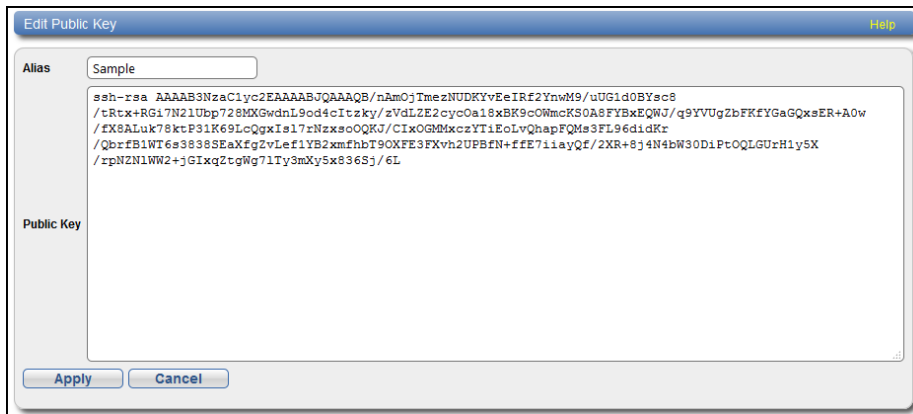

- c. Edit the **Alias** name.

**Note:** The key cannot be modified. To remove a key, see [Delete an Alias Name on page 342](#).

- d. Click **Apply**.

The "Successfully performed Security action" message appears.

- e. Click **OK**.

The updated key appears in the **Available SSH Public Keys** table.

### Delete an Alias Name

- a. Select the check box next to the public key in the **Available SSH Public Keys** table.
- b. Click **Delete**.

The **Delete Public Key** page displays (see [Figure 218 on the next page](#)).

**Figure 218:** Delete Public Key Page

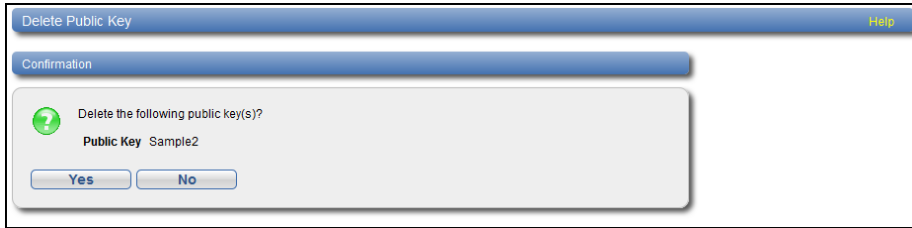

c. Click **Yes**.

The "Successfully performed Security action" message appears.

d. Click **OK**.

The key is removed from the **Available SSH Public Keys** table.

3. In addition to configuring SSH authentication, the SSH service account may also be configured with password authentication.

- Select the **Allow login with password** check box to enable a password on a CLI administrator or CLI viewer account
- Clear the **Allow login with password** check box to disable a password on a CLI administrator or CLI viewer account

Enter the following information:

<b>New Password</b>	Enter the new password.
<b>Confirm New Password</b>	Enter the new password again to confirm it.

#### Additional Information

- Passwords can be up to 20 characters. Alphanumeric characters and special characters are allowed.
- For accounts enabled with both SSH and password authentication, the DXi system will first attempt SSH authentication. If there are no keys defined or no client key matches, the DXi system will fall back to password authentication.

4. Click **Apply**.

## SSL

The **SSL** page allows you to enable or disable SSL on the DXi6900. You can also install a new SSL certificate to replace the Quantum default SSL certificate.

To access the **SSL** page, on the **Security** page, click the **SSL** tab (see [Figure 219 on the next page](#)).

**Figure 219:** SSL Page



### Tasks

- Use the **SSL** page to perform the following tasks:
- Enable or disable SSL on the DXi6900 (see [Enabling SSL below](#)).

**i Note:** If you enable SSL, see [Server Authentication Warnings below](#) for important information about Web browser settings.

- Install a new SSL certificate (see [Installing an SSL Certificate on the next page](#)).

### Enabling SSL

SSL (Secure Sockets Layer) is a protocol that provides security and privacy over the Internet by negotiating encryption keys before transmitting data between a client and a server.

To establish a secure connection, the DXi6900 must have an encryption key assigned to it by a Certification Authority in the form of a certificate file, private key file, and pass phrase. After you install these components, you can establish a secure connection using the SSL protocol. The DXi6900 comes with a Quantum default SSL certificate.

To enable or disable SSL:

1. Under **SSL Properties**, select the **Enable SSL** option to enable SSL.  
Or select the **Disable SSL** option to disable SSL.

**i Note:** The default setting is disabled.

2. Click **Apply**.

### Server Authentication Warnings

Enabling SSL with the default Quantum certificate allows you to securely communicate with the DXi6900 Web-based interface using SSL encryption. However, you may receive a warning from your Web browser

and network security scanners stating that the server you are attempting to connect to does not match the server embedded within the certificate.

This is expected behavior because the default certificate can only be used for encryption and not server authentication. Quantum recommends the default Quantum certificate be replaced with your own official certificate specific to your DXi system. You can install your own custom certificate in order to take advantage of server authentication in addition to encrypted communication.

To suppress server authentication warnings for the default certificate:

- **Internet Explorer** - If a dialog box displays warning you of a possible certificate error, add the IP address for the DXi6900 to the **Trusted Sites** list (**Tools > Internet Options > Security > Trusted Sites**). If subsequent warning pages display along with an option to close your Web browser or continue to the Web site, click **Continue**. This suppresses the warnings until you restart your Web browser.
- **Firefox** - If the **Secure Connection Failed** dialog box displays, click the link at the bottom of the dialog box and follow the instructions to add an exception for your DXi6900.

### Installing an SSL Certificate

You can purchase and install your own custom SSL certificate in order to take advantage of server authentication in addition to encrypted communication on the DXi6900.

To install an SSL certificate:

1. Under **Certificate**, click **New**.

The **Install New Certificate** page displays (see [Figure 220 below](#)).

**Figure 220:** Install New Certificate Page



2. In the **Certificate File** box, type the location and filename of the new SSL certificate file.  
Or click **Browse** to browse the system and locate the SSL certificate file. The SSL certificate file must be named **server.crt**.
3. Click **Upload**.
4. Type your SSL private key and press **<Enter>**.
5. Type your SSL passphrase and press **<Enter>**.

A **Successful Upload** page displays stating that the SSL certificate file has been installed on the system.

6. Click **OK**.

The certificate displays in the **Certificate** section.

## Data Encryption

The **Data Encryption** page allows you to select the type of encryption to use for OST data transfers. OST data sent from the media server to the DXi can be encrypted using AES (Advanced Encryption Standard) encryption methods.

This setting does not apply to data transfers during replication. For replication, specify encryption settings when configuring the replication or failback targets (see [Replication on page 131](#)).

To access the **Data Encryption** page, on the **Security** page, click the **Data Encrypton** tab (see [Figure 221 below](#)).

**Figure 221:** Data Encryption Page

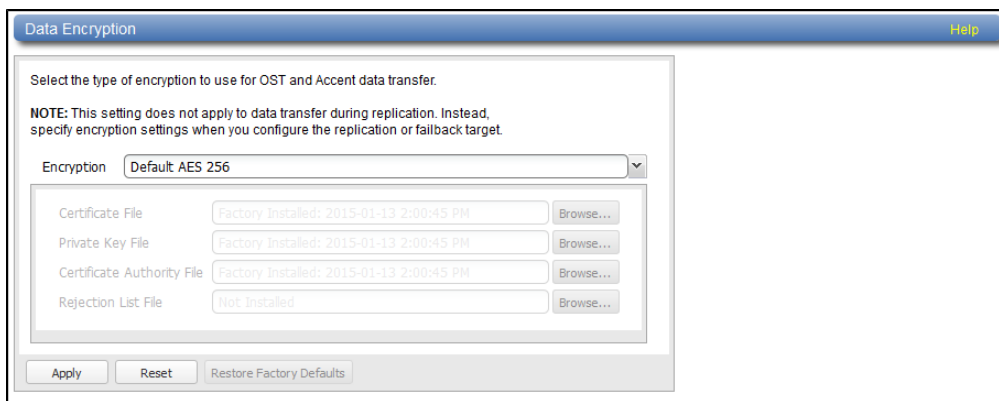

To enable or disable data encryption:

1. Select an option in the **Encryption** drop-down box:

<b>None</b>	OST data is not encrypted.
<b>Default AES 128</b>	OST data is encrypted using AES 128-bit encryption.
<b>Default AES 256</b>	OST data is encrypted using AES 256-bit encryption.
<b>TLS with AES 256</b>	OST data is encrypted using AES 256-bit encryption with Transport Layer Security (TLS).

**i Note:** AES encryption options are available only if the Data-in-Flight license is installed (see [License Keys on page 377](#)).

2. If you selected the **TLS with AES 256** encryption option, you must install the required certificate and key files on the DXi:
  - Certificate File
  - Private Key File
  - Certificate Authority File
  - Rejection List File

The certificate and key files installed on the DXi system must match the files on the OST media server. For more information on certificate and key files, see the *OST Plug-in Installation Instructions (6-67074)*.

To install a file, click the **Browse** button to browse the system and locate the file, and then click **Open**.

---

**Caution:** Installing certificate files requires a system reboot immediately after the changes are applied. Wait for at least 15 minutes before logging back in.

---

**Note:** You can install new certificate and key files at any time, as long as there are no active network connections between the OST media server and the DXi.

3. Click **Apply**.

---

**Note:** To clear all changes without saving them, click **Reset**. To remove user installed certificate and key files, click **Restore Factory Defaults**.

## Login Session

The **Login Session** page allows you to specify the inactivity timeout for the DXi6900 remote management console. The default timeout is 30 minutes.

When the remote management console is inactive for the specified period of time, the user is automatically logged off and must log back on to continue (see [Accessing Remote Management on page 65](#)).

To access the **Login Session** page, on the **Security** page, click **Login Session** (see [Figure 222 below](#)).

**Figure 222:** Login Session Page



To specify the inactivity timeout:

1. In the **Inactivity Timeout** box, enter the number of minutes of inactivity before a user is automatically logged off (1–600 minutes).
2. Click **Apply**.

## Security Notice

The **Security Notice** page allows you to specify a message that will appear to all users when logging on to the remote management console or the CLI (command line interface).

If a security notice message has been specified, the user must accept the message in order to begin using the system. If no security notice has been specified, the user can use the system immediately after logging on.

To access the **Security Notice** page, on the **Security** page, click **Security Notice** (see [Figure 223 below](#)).

**Figure 223:** Security Notice Page



To add or update a security notice message, enter the message in the box and click **Apply**.

## Data-at-Rest Encryption

The **Data-at-Rest** page allows you to enable Data-at-Rest Encryption on the DXi6900 and manage security keys.

### DXi6900

Data-at-Rest Encryption uses Self Encrypting Drive (SED) technology to secure all data stored on the DXi6900. This includes file data and metadata, configuration files, and the DXi software and operating system. To enable Data-at-Rest Encryption, you must supply a passphrase. The passphrase ensures that all physical disks are paired with their respective controllers, and that data can only be read back from the disk by the same controller that wrote it. If a controller must be replaced, the passphrase is needed to enable the new controller to access the data on the physical disks.

To enable Data-at-Rest Encryption, the feature must be licensed, and all of the drive controllers and hard drives (active and hot spares) in the DXi must support Self Encrypting Drive (SED) technology (not available in all regions). A DXi6900 configuration with all 4TB SED hard drives in the Array (RBOD)/Expansion (EBOD) modules and 1.2 TB SED hard drives in the Node meets the requirements for Data-at-Rest Encryption.

### DXi6900-S



Data-at-Rest Encryption uses Self Encrypting Drive (SED) technology to secure all customer data stored on the DXi6900-S Arrays. To enable Data-at-Rest Encryption, you must supply a passphrase. The passphrase ensures that all physical disks are paired with their respective Array controllers, and that data can only be read back from the disk by the same controller that wrote it. If a controller must be replaced, the passphrase is needed to enable the new controller to access the data on the physical disks.

To enable Data-at-Rest Encryption, the feature must be licensed, and all of the drive controllers and hard drives (active and hot spares) in the DXi must support Self Encrypting Drive (SED) technology (not available in all regions). A DXi6900-S configuration with all 8 TB SED hard drives in the Array (RBOD)/Expansion (EBOD) modules meets the requirements for Data-at-Rest Encryption.

**Note:** The **Data-at-Rest** page displays only if the Data-at-Rest Encryption feature is supported on the DXi6900 and is licensed for use. For information about installing the Data-at-Rest Encryption license, see [Licensing Data-at-Rest Encryption and Obtaining Premium Feature Keys on page 381](#).

**Caution:** After you enable Data-at-Rest Encryption, you cannot disable it or turn it off. Make sure to back up your passphrase and recovery files, as they may be required for future capacity expansion or in certain, rare hardware failure scenarios (see [Security on page 335](#)).

To access the **Data-at-Rest** page, on the **Security** page, click the **Data-at-Rest** tab (see [Figure 224 below](#)).

**Figure 224:** Data-at-Rest Page

The screenshot shows the 'Data-at-Rest' configuration page. At the top, there's a blue header with 'Data-at-Rest' and a 'Help' link. Below that, the main heading is 'Data-at-Rest Encryption'. The current status is 'Current Data-at-Rest Encryption Disabled' with a 'Check Status' button. There are two main sections: 'Enable Data-at-Rest Encryption' and 'Download/Send Data-at-Rest Recovery File'. The first section has fields for '\*Passphrase' and '\*Confirm Passphrase', with an 'Enable' button. The second section has radio buttons for 'Download' (selected) and 'Email', and fields for '\*Email Recipient', '\*Password', and '\*Confirm Password', with an 'Apply' button. Both sections have '\* Required field' labels.

## Tasks

Use the **Data-at-Rest** page to perform the following tasks:

- Check the current status of Data-at-Rest Encryption (see [Checking Data-at-Rest Encryption Status on the next page](#)).

- Enable Data-at-Rest Encryption for all hard drives in the DXi6900 (see [Security on page 335](#)).
- Save or e-mail a Data-at-Rest Recovery file to back up your encryption keys (see [Managing Recovery Files on the next page](#)).
- Upload a premium feature key (PFK) file to enable Data-at-Rest Encryption on a supported Array module (see [Uploading a PFK File on page 356](#)).

## Checking Data-at-Rest Encryption Status

The current status of Data-at-Rest Encryption can be **Disabled** (default) or **Enabled**. If it is enabled, all drives in the DXi6900 are securely encrypted and cannot be read if removed from the system.

Click **Check Status** to view detailed information about the status of Data-at-Rest Encryption and to see if the DXi6900 supports all requirements for enabling the feature.

When Data-at-Rest Encryption is enabled, all hard drives in the DXi6900 are paired to their respective RAID controllers using encryption keys. These keys are generated using a passphrase that you supply.

**Note:** Before you can enable Data-at-Rest Encryption, you must install the required license (see [Licensing Data-at-Rest Encryption and Obtaining Premium Feature Keys on page 381](#)). You must also upload a Premium Feature Key (PFK) file for each Array module in the DXi6900 (see [Security on page 335](#)).

**Caution:** Make sure you are certain you want to enable Data-at-Rest Encryption before proceeding. After you enable Data-at-Rest Encryption, you cannot disable it or turn it off.

To enable Data-at-Rest Encryption:

1. Verify that the system is in an optimal state:

- All hardware statuses on the system are **Normal** (see [Hardware on page 178](#)).

**Caution:** All storage arrays *must* show **Normal** condition (see [Details on page 179](#)). If any storage arrays are degraded, do *not* enable Data-at-Rest Encryption.

- All outstanding administration alerts are deleted (see [Admin Alerts on page 206](#)).
- All service tickets are closed (see [Service Tickets on page 207](#)).

2. Under **Enable Data-at-Rest Encryption**, type a security passphrase in the **Passphrase** box.

**Caution:** If you are re-enabling Data-at-Rest Encryption, you *must* enter the same passphrase that was used when encryption was originally enabled.

The passphrase must meet all of the following requirements:

- Must be 8–32 characters long.
- Must contain at least 1 digit [0–9].
- Must contain at least 1 uppercase letter [A–Z].

- Must contain at least 1 lowercase letter [a–z].
- Must contain at least 1 non-alphanumeric character, for example, '+' or '@'.

---

**i Note:** An underscore [ \_ ] is considered an alphanumeric character.

- Must *not* contain a space, tab, single quote ['], double quote ["], or dollar sign [\$].
3. Enter the passphrase again in the **Confirm Passphrase** box.
  4. Click **Enable**.

Data-at-Rest Encryption is now enabled, and all hard drives are secured so that, if they are removed from the DXi6900, they cannot be read using another system or device.

Be sure to record the passphrase in a safe location. You should also save a backup copy of the Data-at-Rest Recovery file (see [Managing Recovery Files below](#)).

### Managing Recovery Files

When Data-at-Rest Encryption is enabled, the system generates security keys based on the supplied passphrase. The DXi6900 maintains a copy of the security keys on the system, and they are accessed automatically as needed.

There are a few, rare situations which may require manual entry of the passphrase or security key, such as performing a capacity expansion, or in the case of certain hardware failure scenarios. For this reason, you should record the passphrase in a safe location. In addition, you should back up the security keys by downloading or sending a Data-at-Rest Recovery file.

To download or send a copy of the recovery file:

1. Under **Download/Send Data-at-Rest Recovery File**, select an option:

---

<b>Download</b>	Downloads a copy of the recovery file using the Web browser.
<b>Email</b>	Sends a copy of the recovery file using e-mail. If selecting this option, type the e-mail address where you want to send the recovery file in the <b>Email Recipient</b> box.

---

**i Note:** For the DXi6900 to send an e-mail, you must specify an outgoing e-mail server (see [Email on page 304](#)).

2. Type a security password in the **Password** box, and type it again in the **Confirm Password** box.

This password is used to protect the recovery file. You will be prompted for this password when opening the recovery file.

The password must meet all of the following requirements:

- Must be 8–32 characters long.
- Must contain at least 1 digit [0–9].
- Must contain at least 1 uppercase letter [A–Z].

- Must contain at least 1 lowercase letter [a–z].
- Must contain at least 1 non-alphanumeric character, for example, '+' or '@'.

---

**i Note:** An underscore [ \_ ] is considered an alphanumeric character.

- Must *not* contain a space, tab, single quote ['], double quote ["], or dollar sign [\$].

3. Click **Apply**.

For the download option, click **OK** or **Save** to save the recovery file to your computer. For the e-mail option, the recovery file is automatically sent to the e-mail address you specified.

Keep a copy of the recovery file in a safe location in case it is needed later. The recovery file is a password-protected ZIP format file. To unzip the file, you must enter the password specified in step 2 above. The recovery file contains the passphrase used to enable Data-at-Rest Encryption as well as the security keys.

### Uploading a PFK File

To enable Data-at-Rest Encryption, a Premium Feature Key (PFK) file is required for each Array module in the DXi6900. After you have uploaded a PFK file to an Array module, it can be enabled for Data-at-Rest Encryption.

Typically you will upload a PFK for each Array module prior to enabling Data-at-Rest Encryption. A PFK file must also be uploaded when adding an Array module to a DXi6900 that has Data-at-Rest Encryption enabled, or else the module will not be encrypted.

---

**i Note:** The **Upload Premium Feature Key (PFK) File** section displays only if a PFK file is required. For instructions on how to obtain the required PFK file for each Array module, see [Licensing Data-at-Rest Encryption and Obtaining Premium Feature Keys on page 381](#).

---

**i Note:** Before uploading a PFK file, make sure you are using a supported Web browser (see [Supported Browsers on page 50](#)).

To upload a PFK file to an Array module:

1. Under **Upload Premium Feature Key (PFK) File**, select an Array module in the **Storage Array** drop-down box. The PFK will be uploaded to this module (**Qarray1** or **Qarray2**) (**Qarray1**, **Qarray2**, or **Qarray3**).

The following information displays:

- **Qarray ID** - The identification number of the Array module.
- **Feature ID** - The feature identification number of the Array module.
- **PFK Installed** - The PFK status (**No** for not installed, or **Yes** for installed).

---

**i Note:** The Qarray ID and Feature ID are required to initially obtain the PFK file. If a PFK is already installed, there is no need to upload a PFK file.

2. In the **PFK File Upload** box, type the location and filename of the PFK file. Or click the button to browse the system and locate the PFK file.

 **Caution:** If you are uploading more than one PFK file, check the file names carefully, and make sure to upload the correct file to each Array module.

3. Click **Upload**.

The PFK file is uploaded to the selected Array module. The module can now be enabled for Data-at-Rest Encryption.

## Manage Users (DXi6900-S)

The **Manage Users** page allows you to create and manage local authenticated users for use with the OpenStorage (OST), Oracle Recovery Manager (RMAN), and path to tape (PTT) capabilities.

### OpenStorage (OST) and Oracle Recovery Manager (RMAN)

After you create OST or RMAN user credentials, enter them in the backup application to authenticate on the media (OST) or Oracle (RMAN) server.

 **Note:** When using OST Automatic Image Replication (AIR), the remote user credentials specified on the source DXi must match the local user credentials on the target (remote) DXi.

### Path to Tape (PTT)

The following applications are supported for backup application specific path to tape:

- Veritas NetBackup
- Veritas Backup Exec
- EMC Networker
- Oracle Secure Backup
- ASG-Time Navigator

 **Note:** You must dedicate a partition within the DXi6900 for use with NetBackup Direct to Tape (Path to Tape). The partition cannot be shared with another backup application.

 **Caution:** The virtual media changer and tape drives *must* be assigned to the backup server (on the SAN) being used for Backup Application Specific path to tape functionality.

To access the **Manage Users** page, on the **System** page, click the **Manage Users** tab (see [Figure 225 on the next page](#)).

**Figure 225:** Manage Users Page

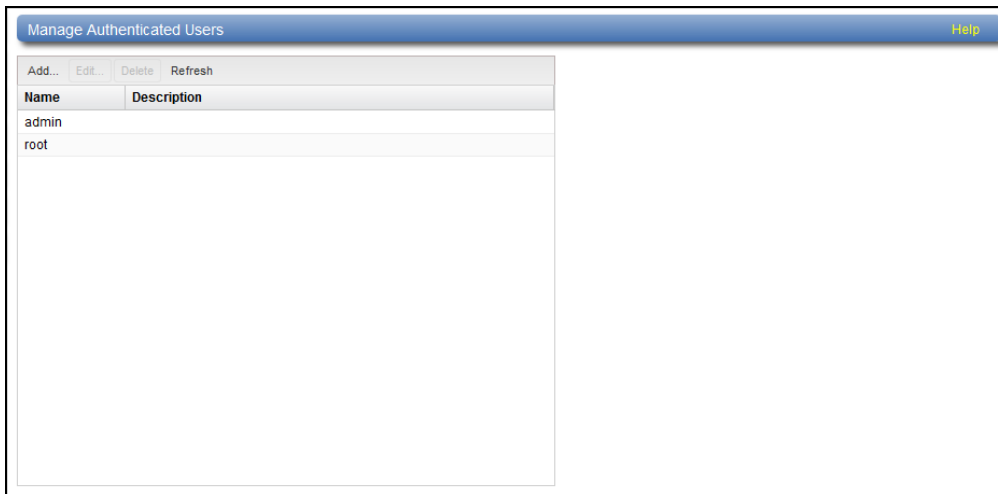

### Tasks

Use the **Manage Users** page to perform the following tasks:

- View information about local authenticated users (see [Manage Authenticated Users List below](#)).
- Add a local authenticated user (see [Adding an Authenticated User below](#)).
- Edit a local authenticated user (see [Editing an Authenticated User on the next page](#)).
- Delete a local authenticated user (see [Deleting an Authenticated User on page 360](#)).

## Manage Authenticated Users List

The **Manage Authenticated Users** list displays the following information for all local authenticated users:

<b>Name</b>	The name of the local authenticated user.
<b>Description</b>	A brief description of the local authenticated user (if available).

**Note:** To update the list with the latest information, click **Refresh**.

## Adding an Authenticated User

Add an authenticated user to create local user credentials. The user credentials are required to authenticate devices on a media server. User credentials are also required to enable the DXi to receive duplicated data using OST AIR.

To add an authenticated user:

1. Click **Add**.

The **Add User Credential** window displays (see [Figure 226 below](#)).

**Figure 226:** Add User Credential

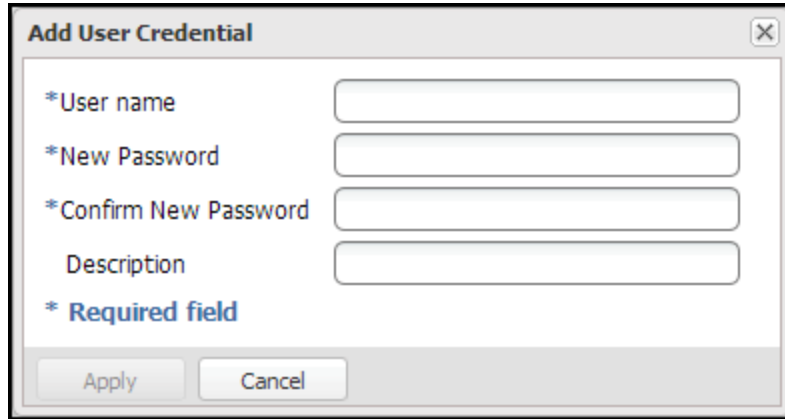

The screenshot shows a dialog box titled "Add User Credential" with a close button (X) in the top right corner. It contains four input fields: "\*User name", "\*New Password", "\*Confirm New Password", and "Description". The first three fields are marked as required. There are "Apply" and "Cancel" buttons at the bottom.

2. Enter information about the authenticated user:

<b>User name</b>	Enter the name of the authenticated user.
<b>New Password</b>	Enter the password for the authenticated user.
<b>Confirm New Password</b>	Enter the password again to confirm it.
<b>Description</b>	(Optional) Enter a brief description of the authenticated user.

3. Click **Apply**.

## Editing an Authenticated User

Edit an authenticated user to change the user's password or description.

To edit an authenticated user:

1. Select the user and click **Edit**.

The **Edit User Credentials** window displays (see [Figure 227 on the next page](#)).

Figure 227: Edit User Credentials

The screenshot shows a dialog box titled "Edit User Credentials". It contains the following fields and labels:

- \*User name: admin
- \*New Password: (empty)
- \*Confirm New Password: (empty)
- Description: (empty)

A legend below the fields states: \* Required field. At the bottom of the dialog are "Apply" and "Cancel" buttons.

2. Enter information about the authenticated user:

**Note:** If you are editing an authenticated user, you cannot change the **User name**.

<b>New Password</b>	Enter the password for the authenticated user.
<b>Confirm New Password</b>	Enter the password again to confirm it.
<b>Description</b>	(Optional) Enter a brief description of the authenticated user.

3. Click **Apply**.

## Deleting an Authenticated User

Delete an authenticated user if the user credentials are no longer needed to authenticate devices on a media server.

To delete an authenticated user, select the user and click **Delete**.

**Note:** You can select multiple users to delete at once.

## Client Plug-Ins (DXi6900-S)

Use the **Client Plug-In** page to download the Quantum the following client plug-ins:

- OST (OpenStorage)
- RMAN (Oracle Recovery Manager)

**Note:** Running an RMAN and OST Plug-in on the same client is not supported by the DXi6900 system.



## OST (OpenStorage)

OST (OpenStorage) technology allows Veritas NetBackup and Backup Exec to seamlessly integrate with the DXi6900. Using OST, NetBackup and Backup Exec can manage backups through the DXi6900 and can take advantage of the system's capabilities, such as data deduplication and replication. To use OST, you must first download the OST Plug-in and install it on the NetBackup or Backup Exec media server.

To download the OST Plug-in, click **Client Plug-in Download** (see [Figure 228 below](#)). On the download page, download the correct OST Plug-in for your backup application and operating system. Also on the download page, click **Installation Instructions**, to download the *OST Plug-in Installation Instructions*. Follow the included instructions to install the OST Plug-in on your media server.

---

**i Note:** For information about configuring and using OST with the DXi6900, see the *DXi-Series NetBackup and Backup Exec OST Configuration Guide* (6-67079).

## Oracle Recovery Manager (RMAN)

Recovery Manager (RMAN) is an Oracle utility that can back up, restore, and recover database files. Using RMAN, an Oracle database server can manage RMAN share backups through the DXi6900 and can take advantage of the system's capabilities, such as data deduplication and replication. To use RMAN, you must first download the RMAN Plug-in and install it on the Oracle server.

To download the RMAN Plug-in, click **Client Plug-in Download** (see [Figure 228 below](#)). On the download page, download the correct RMAN Plug-in for your operating system. Also on the download page, click **Installation Instructions**, to download the *RMAN Plug-in Installation Instructions*. Follow the included instructions to install the RMAN Plug-in on your media server.

---

**i Note:** For information about configuring and using RMAN with the DXi6900, see the *RMAN Configuration Guide*.

**Figure 228:** Client Plug-Ins Page

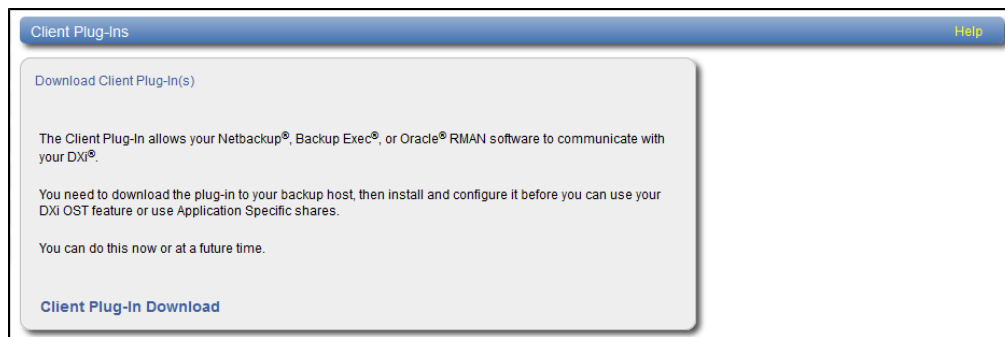

# FC Initiators and Targets

The **FC Initiators & Targets** page allows you to see all path to tape initiator and target ports and their associated World Wide Port Numbers (WWPNs). You can also change a Fibre Channel port to initiator or target mode.

To access the **FC Initiators & Targets** page, on the **System** page, click the **FC Initiators & Targets** tab (see [Figure 229 below](#)).

**Figure 229:** FC Initiators and Targets Page

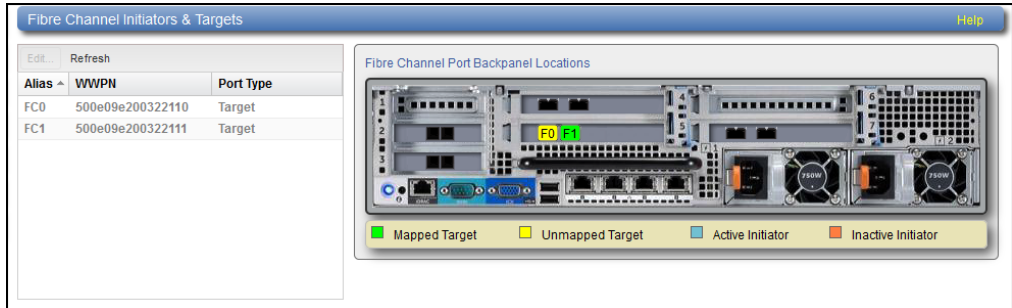

## Tasks

Use the **FC Initiators & Targets** page to perform the following tasks:

View information about initiator and target Fibre Channel ports (see [Fibre Channel Initiators and Targets List below](#)).

Change the mode of a Fibre Channel port (see [Editing the Fibre Channel Port Type on the next page](#)).

## Fibre Channel Initiators and Targets List

The **Fibre Channel Initiators & Targets** section displays the following information for all Fibre Channel ports:

<b>Alias</b>	The alias of the Fibre Channel port.
<b>WWPN</b>	The World Wide Port Number of the Fibre Channel Port.
<b>Port Type</b>	The current mode of the Fibre Channel port ( <b>Initiator</b> or <b>Target</b> ).

**Note:** Click **Refresh** to update the list with the latest port information.

The **Backpanel Locations** section displays a graphical representation of the Fibre Channel ports as they appear on the rear of the system. The diagram shows the status of each Fibre Channel port: **Mapped Target** (green), **Unmapped Target** (yellow), **Active Initiator** (blue), or **Inactive Initiator** (orange).

## Editing the Fibre Channel Port Type

Edit the port type to change the mode of a Fibre Channel port to initiator or target mode. You can change the port mode only on inactive connections:

### Additional Information

- Before changing a Fibre Channel port type from initiator to target, unplug the Fibre Channel port wire connection.
- Before changing a Fibre Channel port type from target to initiator, un-map any host mapping on the Fibre Channel port, and unplug the Fibre Channel port wire connection.

To edit the Fibre Channel Port type:

1. Select the port in the list and click **Edit**.
2. Select the new port mode (**Initiator** or **Target**) in the drop-down box,
3. Click **Update**.

---

# Contacts

The **Contacts** page allows you to enter company information. You can also enter individual contact information for primary and secondary contacts.

To access the **Contacts** page, click the **Configuration** menu, and then click the **Contacts** tab.

The **Contacts** page contains the following tabs:

- [Company below](#)
- [Primary and Secondary on the next page](#)

## Company

The **Company** page allows you to enter information about the company and location of the DXi6900.

To access the **Company** page, on the **Contacts** page, click the **Company** tab (see [Figure 230 on the next page](#)).

**Figure 230:** Company Page

The screenshot shows a web form titled "Company Information" with a "Help" link in the top right corner. The form contains the following fields:

- Company Name
- Street
- City
- State
- Postal Code
- Country
- DXi4701 - NAS Location
- Support Contract

An "Apply" button is located at the bottom left of the form.

To enter company information:

1. Enter the following information:

<b>Company Name</b>	Enter the company name.
<b>Street</b>	Enter the company street address.
<b>City</b>	Enter the company city.
<b>State</b>	Enter the company state.
<b>Postal Code</b>	Enter the company postal code.
<b>Country</b>	Enter the company country.
<b>DXi6900Location</b>	Enter the physical location of the DXi6900 (for example, data center).
<b>Support Contract</b>	Enter the support contract number for the DXi6900.

2. Click **Apply**.

## Primary and Secondary

The **Primary** and **Secondary** pages allow you to enter information about the primary and secondary contacts for the DXi6900.

To access the **Primary** or **Secondary** page, on the **Contacts** page, click the **Primary** or **Secondary** tab (see [Figure 231 on the next page](#)).

**Figure 231:** Primary and Secondary Pages

The screenshot shows a web form titled "Primary Contact Information" with a "Help" link in the top right corner. The form contains ten text input fields stacked vertically, each with a label to its left: "Name", "Email Address", "Phone", "Fax", "Pager", "Street", "City", "State", "Postal Code", and "Country". At the bottom left of the form area is a button labeled "Apply".

To enter primary or secondary contact information:

1. Enter the following information:

<b>Name</b>	Enter the contact name.
<b>Email Address</b>	(Required) Enter the contact e-mail address.
<b>Phone</b>	Enter the contact phone number.
<b>Fax</b>	Enter the contact fax number.
<b>Pager</b>	Enter the contact pager number.
<b>Street</b>	Enter the contact street address.
<b>City</b>	Enter the contact city.
<b>State</b>	Enter the contact state.
<b>Postal Code</b>	Enter the contact postal code.
<b>Country</b>	Enter the contact country.

2. Click **Apply**.



# Chapter 10: Utilities

---

This chapter contains the following topics:

DXi6900 Utilities Overview .....	366
Diagnostics .....	367
Analyzer .....	372
Space Reclamation .....	374
License Keys .....	377
Secure Shred .....	382
Software Upgrades .....	384
Reboot & Shutdown .....	391

---

## DXi6900 Utilities Overview

The **Utilities** pages to perform maintenance tasks on the DXi6900, such as generating and downloading diagnostic files, analyzing disk and network performance, managing space reclamation, and securely erasing the system. You can also install license keys, upgrade the system software, and reboot or shut down the DXi6900.

To access the **Utilities** pages, click the **Utilities** menu.

The **Utilities** pages contain the following tabs:

- [Diagnostics below](#)
- [Analyzer on page 372](#)
- [Space Reclamation on page 374](#)
- [License Keys on page 377](#)
- [Secure Shred on page 382](#)
- [Software Upgrades on page 384](#)
- [Storage](#)
- [Reboot & Shutdown on page 391](#)

---

## Diagnostics

The **Diagnostics** page allows you to generate and download diagnostic files. You can also perform healthchecks to verify the health and integrity of the data deduplication blockpool.

The diagnostic files are helpful when troubleshooting problems on the DXi6900. Generate and download the diagnostic files before contacting Quantum customer support.

To access the **Diagnostics** page, click the **Utilities** menu, and then click the **Diagnostics** tab.

The **Diagnostics** page contains the following tabs:

### System Diag File

The **System Diag File** page allows you to generate and download a system diagnostics file. This file contains the diagnostic logs for all of the system components.

To access the **System Diag File** page, on the **Diagnostics** page, click the **System Diag File** tab (see [Figure 232 below](#)).

**Figure 232:** System Diag File Page

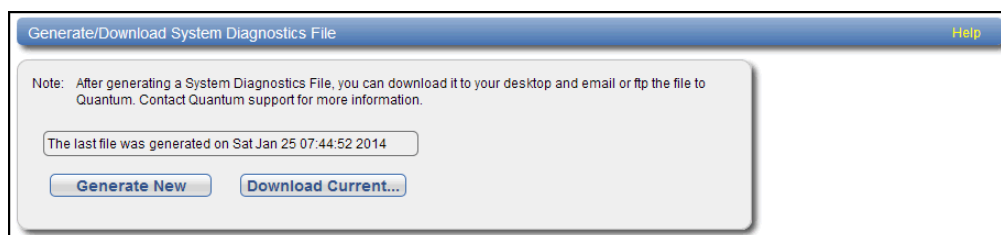

To generate and download a system diagnostics file:

1. Click **Generate New** to generate a new system diagnostics file.

The system generates a new diagnostics file. This can take several minutes.

2. After the file finishes generating, click the link to enable the **Download Current** button.
3. To download the generated diagnostics file, click **Download Current**.

A dialog box displays asking if you want to open or save the file.

4. Click **Save** or **OK** to download the file.

## Storage Array Diag File

The **Storage Array Diag File** page allows you to generate and download a storage array diagnostics file. This file contains the diagnostic logs for the storage arrays.

To access the **Storage Array Diag File** page, on the **Diagnostics** page, click the **Storage Array Diag File** tab (see [Figure 233 below](#)).

**Figure 233:** Storage Array Diag File Page

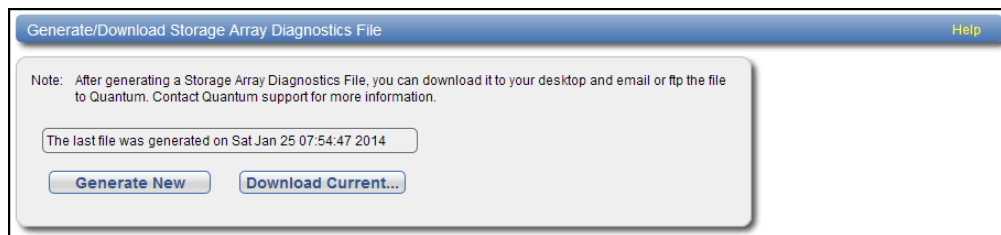

To generate and download a system diagnostics file:

1. Click **Generate New** to generate a new storage array diagnostics file.  
The system generates a new diagnostics file. This can take several minutes.
2. After the file finishes generating, click the link to enable the **Download Current** button.
3. To download the generated diagnostics file, click **Download Current**.  
A dialog box displays asking if you want to open or save the file.
4. Click **Save** or **OK** to download the file.

## DSET

The **DSET** page allows you to generate a DSET report. DSET is a hardware diagnostic utility included with the DXi6900. A DSET report contains an array of status information about the DXi6900 hardware. A Quantum customer support representative can use this information to help identify and diagnose problems.

**i Note:** Generate a DSET report only if directed to do so by a Quantum customer support representative.

To access the **DSET** page, on the **Diagnostics** page, click the **DSET** tab (see [Figure 234 on the next page](#)).



**Figure 234:** DSET Page

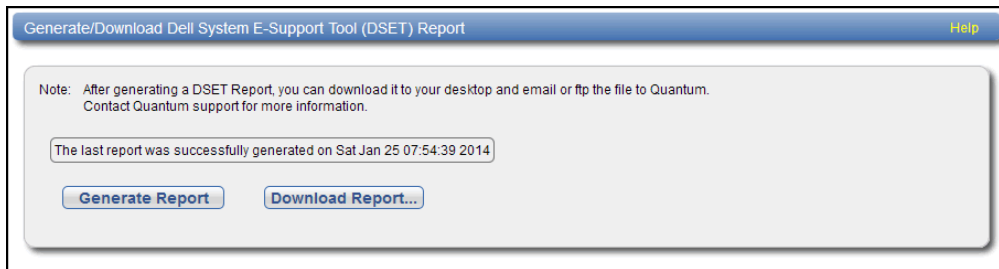

To generate a DSET report:

1. Click **Generate Report**.

Click **OK** to continue. The system generates a new DSET report. This can take several minutes.

**Note:** You may see error or warning messages in the status text as the DSET report is generated. This is expected and does not indicate a problem with the report.

2. To download the newly generated DSET report, click **Download Report**.

A dialog box displays asking if you want to open or save the file.

3. Click **Save** or **OK** to download the file.

The DSET report is saved as a compressed zip file to the specified location.

4. Locate the DSET report you downloaded and send it to the e-mail or FTP address provided by Quantum Customer Support.

## Healthchecks

The **Healthchecks** page allows you to perform tests that verify the health and integrity of the data deduplication blockpool. You can also enable and disable healthchecks.

**Note:** To configure the DXi6900 to automatically run the healthchecks at specified intervals, use the **Configuration > Scheduler** page (see [Scheduling Healthchecks on page 302](#)).

To access the **Healthchecks** page, on the **Diagnostics** page, click the **Healthchecks** tab.

The **Healthchecks** page contains the following tabs:

### General

The **General** page allows you to start running the healthchecks or stop them if they are already running. When you start the healthchecks, only the healthchecks that are currently enabled are run (see [Diagnostics on page 367](#)).

To access the **General** page, on the **Healthchecks** page, click the **General** tab (see [Figure 235 on the next page](#)).

**Figure 235:** General Page

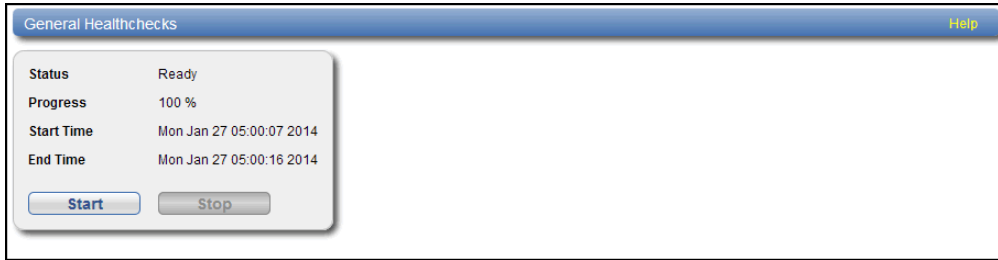

The **General** page displays the following information about the most recently run healthchecks:

<b>Status</b>	The status of the healthchecks ( <b>In Progress</b> , <b>Success</b> , <b>Failed</b> , or <b>Interrupted</b> ).
<b>Progress</b>	The percentage complete of the healthchecks.
<b>Start Time</b>	The time the healthchecks started.
<b>End Time</b>	The time the healthchecks ended.

Use the **General** page to perform the following tasks:

- To start all enabled healthchecks, click **Start**.
- To stop all healthchecks in progress, click **Stop**.

## Status

The **Status** page allows you to view information about the most recent test results for each healthcheck. You can also enable or disable a healthcheck.

The following healthchecks are available:

- **De-Duplication** - Checks the overall health of the blockpool. This healthcheck verifies that the metadata in the namespace file and the data tags in the blockpool are correctly in sync.
- **Integrity** - Checks the integrity of data in the blockpool. This healthcheck examines a sample of data tags in the blockpool and verifies that the data has been properly stored without errors or corruption.

To access the **Status** page, on the **Healthchecks** page, click the **Status** tab (see [Figure 236 on the next page](#)).

**Figure 236:** Status Page

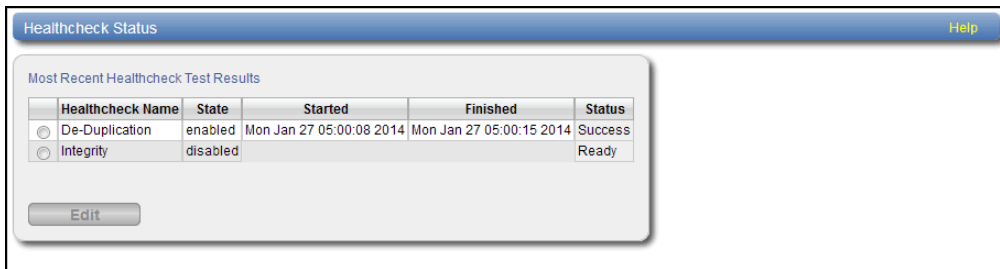

The **Status** page displays the following information about the most recently run test for each healthcheck:

<b>Healthcheck Name</b>	The name of the healthcheck.
<b>State</b>	The state of the healthcheck ( <b>enabled</b> or <b>disabled</b> ).
<b>Started</b>	The time the healthcheck started
<b>Finished</b>	The time the healthcheck ended.
<b>Status</b>	The status of the healthcheck ( <b>Success</b> or <b>Failed</b> ).

**i Note:** If running a healthcheck results in the Contact Support status, contact Quantum Customer Support for further assistance.

To enable or disable a healthcheck:

1. Select the healthcheck and click **Edit**.

The **Edit Healthcheck** page displays (see [Figure 237 below](#)).

**Figure 237:** Edit Healthcheck Page

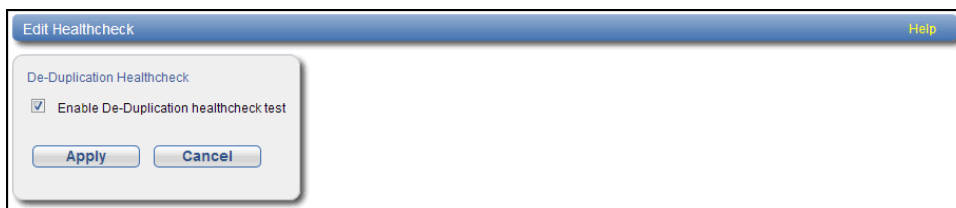

2. Select the check box to enable the healthcheck.  
Or clear the check box to disable the healthcheck.
3. Click **Apply**.

**i Note:** When healthchecks are run (manually or scheduled), only enabled healthchecks are run.

**⚠ Caution:** If a healthcheck fails when it is run, there may be a problem in the blockpool that could cause replication or restore operations to fail. Contact Quantum customer support if a healthcheck fails.

---

# Analyzer

The **Analyzer** page allows you to analyze the network and disk performance of the DXi6900.

To access the **Analyzer** page, click the **Utilities** menu, and then click the **Analyzer** tab.

The **Analyzer** page contains the following tabs:

- [Network Analyzer below](#)
- [Disk Analyzer on page 374](#)

## Network Analyzer

The **Network Analyzer** page allows you to analyze network performance by measuring network throughput between the DXi6900 and another system (such as another DXi system).

To access the **Network Analyzer** page, on the **Analyzer** page, click the **Network** tab.

The **Network Analyzer** page contains the following tabs:

- [Performance below](#)
- [Settings on the next page](#)

### Performance

The **Performance** page allows you to perform network analysis with another system (the target). You can also view results from the most recently run test

To access the **Performance** page, on the **Network Analyzer** page, click the **Performance** tab (see [Figure 238 on the next page](#)).

Figure 238: Performance Page

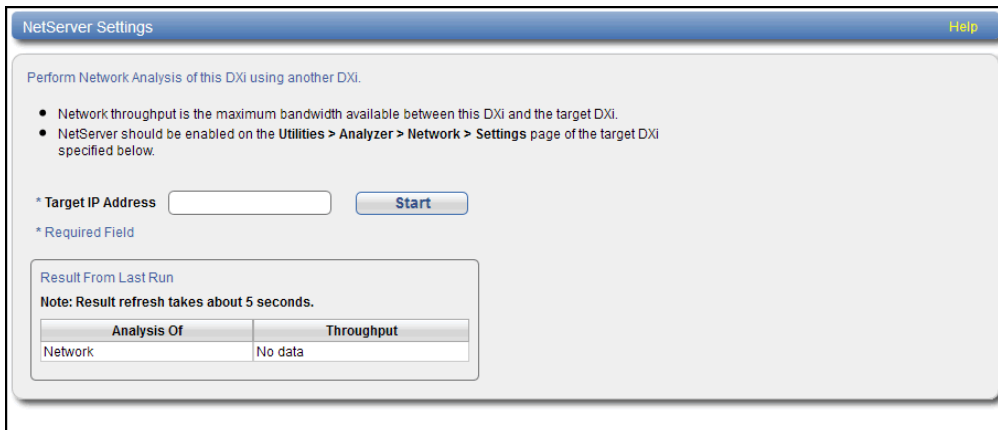

To perform network analysis:

1. In the **Target IP Address** box, enter the IP address of the system to perform network analysis with.  
The target system must have NetServer enabled (see [Settings below](#)).
2. Click **Start**.

The throughput result is displayed under **Result From Last Run** in MB/s.

**i Note:** It takes approximately 5 seconds to refresh the results.

## Settings

The **Settings** page allows you to enable or disable NetServer on the DXi6900. NetServer must be enabled on the target DXi6900 system to perform network analysis with the system (see [Performance on the previous page](#)).

To access the **Settings** page, on the **Network Analyzer** page, click the **Settings** tab (see [Figure 239 below](#)).

Figure 239: Settings Page

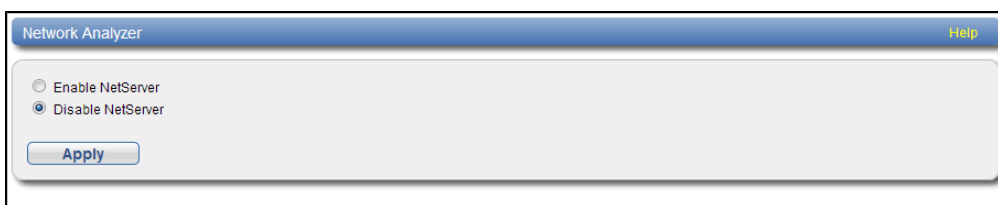

To enable or disable NetServer on the target DXi6900:

1. Select **Enable NetServer** to enable NetServer.  
Or select **Disable NetServer** to disable NetServer.

2. Click **Apply**.

---

**i Note:** You should disable NetServer on the target system when you are done analyzing network performance.

## Disk Analyzer

The **Disk Analyzer** page allows you to analyze disk performance by measuring disk read and write throughput.

To access the **Disk Analyzer** page, on the **Analyzer** page, click the **Disk** tab (see [Figure 240 below](#)).

**Figure 240:** Disk Analyzer Page



To perform disk analysis, click **Start**. The throughput result is displayed under **Result From Last Run** in KB/s.

---

**i Note:** It takes approximately 5 seconds to refresh the results.

---

## Space Reclamation

The **Space Reclamation** page allows you to manage space reclamation activity on the DXi6900. You can start or stop space reclamation. You can also monitor the progress of space reclamation activity.

During space reclamation, the DXi6900 searches the blockpool for tags that are no longer referenced and then deletes the unneeded tags to free up space.

In addition, the DXi automatically compacts reclaimable space in the following ways:

- During data ingest, reclaimable space is compacted as needed to provide space for new, deduplicated data.
- If the DXi is not in Low Space state, compaction starts when used disk space reaches a high level and there is sufficient reclaimable space. Compaction stops when used disk space falls below the high threshold state. The reclaimed space can be used to store new deduplicated or non-deduplicated data.

- If the DXi is in Low Space state, compaction starts and continues to run until the DXi exits Low Space state. The reclaimed space can be used to store new deduplicated or non-deduplicated data.

**Note:** The current compaction status is displayed on the **Home** page (see [Home Page on page 125](#)).

**Caution:** For correct system operation, space reclamation *must* be run at regular intervals (at least once a week). Quantum recommends creating a schedule to automatically run space reclamation (see [Scheduling Space Reclamation on page 303](#)). Because space reclamation can affect system performance, avoid running space reclamation during known backup periods.

The space reclamation process can include up to four stages (see [Space Reclamation Status on the next page](#)).

<b>New or Normal Mode</b>	To increase performance, when space reclamation is initiated on the <b>Space Reclamation</b> page or as a scheduled event, only Stage 2 (Calculating Deletion Candidates) and Stage 3 (Deleting New Candidates) are run.
<b>Low Space or Legacy Mode</b>	When disk capacity is low, space reclamation is automatically started to free up disk space. In this case, all four stages of space reclamation are run.

To access the **Space Reclamation** page, click the **Utilities** menu, and then click the **Space Reclamation** tab (see [Figure 241 below](#)).

**Figure 241:** Space Reclamation Page

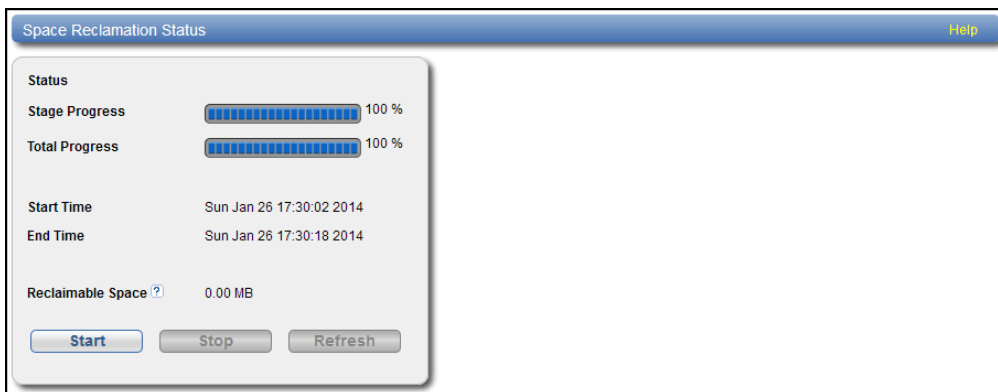

The **Space Reclamation** page displays the following information about the current or most recent space reclamation activity:

<b>Status</b>	The status of space reclamation (see <a href="#">Space Reclamation Status on the next page</a> ).
<b>Stage Progress</b>	The progress of the current space reclamation stage.
<b>Total Progress</b>	The overall progress of space reclamation activity.
<b>Start Time</b>	The time space reclamation started.

<b>End Time</b>	The time space reclamation ended.
<b>Reclaimable Space</b>	<p>The disk space that is occupied by outdated deduplicated data and which will be automatically reused if additional space for new deduplicated data is needed. Displays <b>Pending</b> when space reclamation is running.</p> <p><b>Note:</b> Because the DXi can automatically use reclaimable space to store new deduplicated data, space reclamation statistics may be affected (appear lower) if ingest occurs at the same time as space reclamation.</p>

### Tasks

Use the **Space Reclamation** page to perform the following tasks:

- To start space reclamation, click **Start**.
- To stop space reclamation, click **Stop**.
- To update the display while space reclamation is running, click **Refresh**.

## Space Reclamation Status

Space reclamation can have one of the following statuses:

Status	Description
<b>Reclamation Completed</b>	Space reclamation completed without errors.
<b>Reclamation Started by User</b>	Space reclamation was started manually by a user.
<b>Reclamation Interrupted</b>	Space reclamation was interrupted and must be restarted.
<b>Reclamation Interrupted by User</b>	Space reclamation was interrupted by a user and must be restarted.
<b>Reclamation Interrupted - Error Encountered</b>	Space reclamation was interrupted because an error was encountered and must be restarted.
<b>Reclamation Interrupt by User - Cannot be interrupted at this time</b>	Because the system is in a Low Space state, space reclamation cannot be stopped. Wait for space reclamation to finish freeing up disk space.
<b>Reclamation Completed - No Candidates To Delete</b>	Space reclamation completed, but there were no candidates for reclamation.



Status	Description
<b>Reclaim Existing Blockpool Freed Space</b>	The existing blockpool space has been reclaimed for use.
<b>Stage 1 of 4</b>	Reclaim Disk Space (Initial).
<b>Stage 2 of 4</b>	Calculating Deletion Candidates.
<b>Stage 3 of 4</b>	Deleting New Candidates.
<b>Stage 4 of 4</b>	Reclaim Disk Space.

---

## License Keys

The **License Keys** page allows you to add a license key to the DXi6900 to enable new functionality. You can also view a list of available licenses and see the licenses that are installed on the system.

For all DXi6900 systems, you can add a storage capacity upgrade license key to enable installed hardware capacity. For more information, see [Add a License Key on page 380](#).

### DXi6900

For DXi6900 systems configured with all 4TB hard drives that support Self Encrypting Drive (SED) technology, you can add a license for Data-at-Rest Encryption (not available in all regions). Adding this license also requires uploading one or more Premium Feature Key (PFK) files to the DXi. For more information, see [Add a License Key on page 380](#).

### DXi6900-S

For DXi6900-S systems configured with 8 TB hard drives that support Self Encrypting Drive (SED) technology, you can add a license for Data-at-Rest Encryption (not available in all regions). Adding this license also requires uploading one or more Premium Feature Key (PFK) files to the DXi. For more information, see [Add a License Key on page 380](#).

To access the **License Keys** page, click the **Utilities** menu, and then click the **License Keys** tab (see [Figure 242 on the next page](#)).

Figure 242: License Keys Page

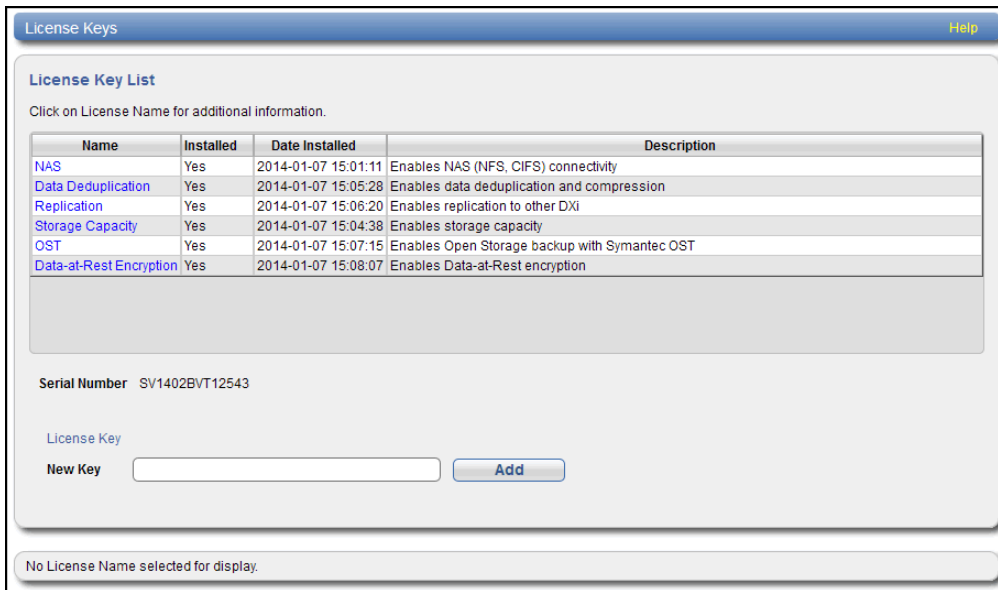

## Tasks

Use the **License Keys** page to perform the following tasks:

- View information about available and installed licenses (see [License Key Information below](#)).
- Add a license key (see [Add a License Key on page 380](#)).
- License the Data-at-Rest Encryption feature (see [Licensing Data-at-Rest Encryption and Obtaining Premium Feature Keys on page 381](#)).

## License Key Information

The **License Key List** displays the following information about licenses that are available for the DXi6900:

<b>Name</b>	The name of the license.  To display details for a license, click the license name. For a description of the licenses that are available on the DXi6900, see <a href="#">Available Licenses below</a> .
<b>Installed</b>	The state of the license ( <b>Yes</b> if the license is installed, <b>No</b> if the license is not installed).
<b>Date Installed</b>	If installed, the date the license was installed.
<b>Description</b>	A brief description of the license.

## Available Licenses

The following licenses are available from Quantum:

License	Description
<b>VTL</b>	Enables the VTL interface to hosts. Additional virtual tape drives licenses are added through the VTL license area. (License key for 80160 VTDs is pre-installed on all DXi6900 models.)
<b>NAS</b>	Enables NAS (NFS, CIFS/SMB) connectivity. (License key is pre-installed on all DXi6900 models.) (License Certificate is included with all DXi6900 models.)
<b>Backup Application Specific</b>	Enables the backup application specific path to tape capability. (License key is pre-installed on all DXi6900 models.)
<b>Data Deduplication</b>	Enables data deduplication and compression. (License key is pre-installed on all DXi6900 models.)
<b>Replication</b>	Enables replication to other DXi systems. (License key is pre-installed on all DXi6900 models.)
<b>Storage Capacity</b>	<p>Enables the purchased storage capacity for the system. (License key is pre-installed on all DXi6900 models.) License key for 17 (DXi6900) or 34 (DXi6900-S) TB storage capacity is pre-installed on all DXi6900 configurations.</p> <p>A storage capacity license key is pre-installed for all capacity shipped from the factory. You must install license keys for additional capacity purchased after the initial point of sale are installed.</p> <p>For configurations larger than 17 (DXi6900) or 34 (DXi6900-S) TB, a license for the total purchased storage capacity ships with the system. In addition, usable storage capacity can be upgraded at any time after purchase by adding a storage capacity upgrade license to enable installed hardware capacity, up to a total of 510 TB (DXi6900) or 544 TB (DXi6900-S).</p> <p><b>i Note:</b> If you purchase a storage capacity upgrade, you will receive a License Certificate you can use to enable the additional capacity (see <a href="#">License Keys on page 377</a>).</p>
<b>OST</b>	Enables OpenStorage backup with Symantec OST. (License key is pre-installed on all DXi6900 models.)
<b>Data-at-Rest Encryption</b>	<p>Enables the use of the Data-at-Rest Encryption capability to secure all data stored on the DXi6900.</p> <p>For more information, see <a href="#">Licensing Data-at-Rest Encryption and Obtaining Premium Feature Keys on page 381</a>.</p>

License	Description
<b>Data-in-Flight Encryption</b>	Enables use of AES encryption (128-bit or 256-bit) when sending data to another system using DXi replication or OST Accent. (Not available in all regions.)

## Add a License Key

Add a license key to enable new functionality or additional storage capacity on the DXi6900. To add a license key, you must first obtain a License Certificate containing an authorization code.

License Certificates for NAS and OST functionality are included with the DXi6900. To purchase a storage capacity upgrade license, contact your Quantum customer support. You will receive a License Certificate containing an authorization code.

To add a license key, locate the License Certificate, and then perform the following steps:

1. Open a Web browser on a computer with Internet access.
2. Enter <http://www.quantum.com/licensekeys> in the browser address box.

The **License Key Management** page displays (see [Figure 243 below](#)).

**Figure 243:** License Key Management Page

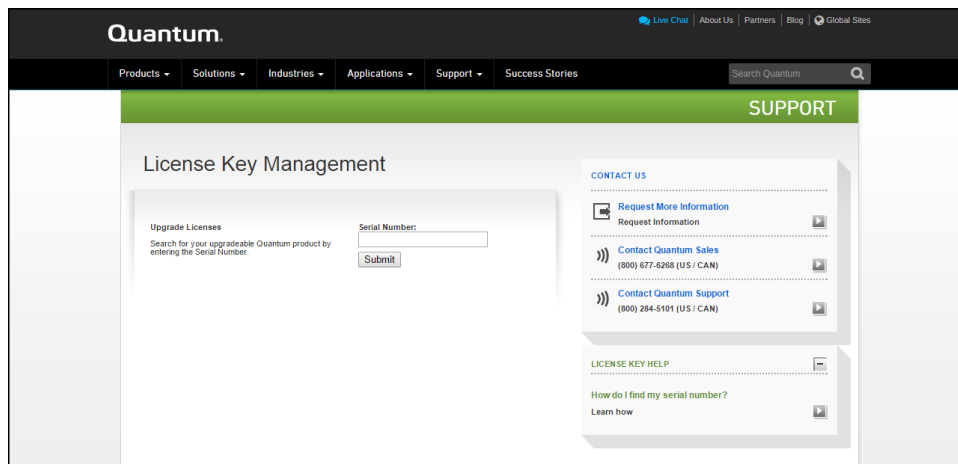

3. Enter the DXi system serial number in the **Serial Number** box and click **Submit**.

The **Licensed Feature** page displays.

**Note:** The serial number displays on the **License Keys** page, above the **New Key** box.

4. Enter the authorization code (printed on the License Certificate) and click **Get License Key**.

The **Licensed Feature** page returns a license key. Print out or write down the license key, or save it to a text file.

5. Access the DXi remote management console (see [Accessing Remote Management on page 65](#)).

6. Click the **Utilities** menu, and then click the **License Keys** tab.

The **License Keys** page displays.

7. Enter the license key in the **New Key** box, and then click **Add**.

The license key is added to the system, and the new feature is enabled.

---

**i Note:** When adding a **Storage Capacity** license, it may take up to 10 minutes for the system to recognize the new storage capacity.

---

**i Note:** When adding a **Storage Capacity** license, you are prompted to reboot the system. The new storage capacity will not be available until you reboot the DXi. Make sure to stop all backup, restore, and replication jobs before rebooting.

## Licensing Data-at-Rest Encryption and Obtaining Premium Feature Keys

### DXi6900 G1/G2

Data-at-Rest Encryption secures all data stored on the DXi6900 G1/G2, including file data and metadata, configuration files, and the DXi software and operating system (see [Data-at-Rest Encryption on page 352](#)).

### DXi6900-S

Data-at-Rest Encryption secures all customer data stored on the DXi6900-S (see [Data-at-Rest Encryption on page 352](#)).

Before you can enable Data-at-Rest Encryption to encrypt hard drives, you must add the Data-at-Rest Encryption license. In addition, you must upload a Premium Feature Key (PFK) file for each Array module in the DXi6900. Contact Quantum customer support to obtain a Data-at-Rest Encryption license. After you obtain the license, you will receive a License Certificate containing an authorization code.

To add the license key and required PFK files to the DXi6900, locate the License Certificate, and then perform the following steps:

1. Open two Web browser windows on a computer with Internet access.

---

**i Note:** During this procedure, you can copy and paste required numbers between these two windows.

- a. In one browser, navigate to the **Utilities > License Keys** page in the DXi remote management console.

Note that the system serial number and Storage Array Feature IDs display directly above the **New Key** box.

- b. In the other browser, enter the address for the **License Key Management** Web site (see ):

<http://www.quantum.com/licensekeys>

2. On the **License Key Management** Web site, perform the following steps:

- a. Enter the system serial number in the **Serial Number** box and click **Submit**.
- b. Enter the authorization code (printed on the License Certificate) and click **Get License Key**.
- c. Enter the **Feature ID** for each storage array.

If entering more than one Feature ID, make sure to enter the correct Feature ID for Storage Array 1 (Qarray1) and Storage Array 2 (Qarray2) Storage Array 1 (Qarray1), Storage Array 2 (Qarray2), and Storage Array 3 (Qarray3).

- d. Click **Get License Key**.

The **License Key Details** section displays the Data-at-Rest Encryption license key. Print out or write down the license key, or save it to a text file.

- e. For each Storage Array, click **Generate PFK File** to generate a Premium Feature Key file, and then click **Save** to save the PFK file to your computer.

---

**i Note:** Make sure to keep a copy of the PFK files for backup purposes.

3. In the DXi remote management console, on the **Utilities > License Keys** page, enter the Data-at-Rest Encryption license key in the **New Key** box, and then click **Add**.

The Data-at-Rest Encryption license key is added to the system.

4. In the DXi remote management console, navigate to the **Configuration > System > Security > Data-at-Rest** page and perform the following steps:
  - a. Upload the correct PFK file to each Storage Array (see [Uploading a PFK File on page 356](#))
  - b. Enable Data-at-RestEncryption for all hard drives in the DXi6900 (see [Security on page 335](#)).
  - c. Make a backup copy of your encryption keys (see [Managing Recovery Files on page 355](#)).

---

## Secure Shred

The **Secure Shred** page allows you to securely and permanently erase sensitive data stored on the DXi6900. To securely erase data, first delete files on NAS shares or storage servers, or erase tape cartridges on VTL partitions, then start secure shred. During secure shred, all residual data associated with the deleted files or cartridges is securely erased from the disk drives by performing a single-pass overwrite with zeros.

While secure shred is running, the DXi6900 operates in limited mode. This means you cannot perform backups or restores, all scheduled jobs (including replication jobs) are stopped, and you cannot access or use any other features of the DXi. If necessary, you can cancel secure shred at any time and return the DXi to normal operation.

---

**⚠ Caution:** The secure shred process can take multiple days to complete.

To access the **Secure Shred** page, click the **Utilities** menu, and then click the **Secure Shred** tab (see [Figure 244 on the next page](#)).

**Figure 244:** Secure Shred Page

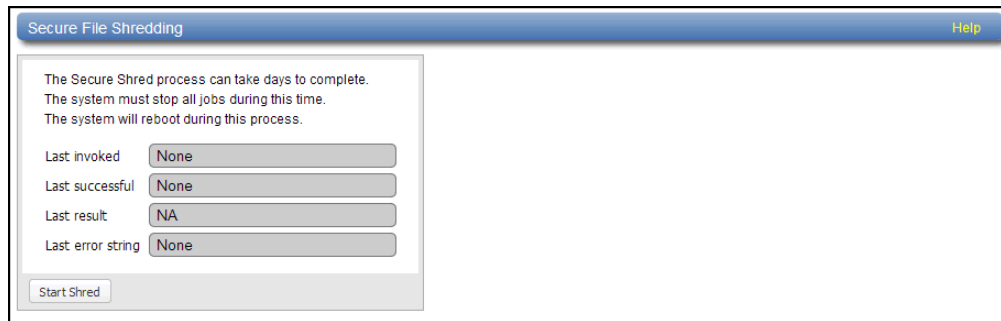

To securely erase data on the DXi6900:

1. Delete the data you want to securely erase:
  - Delete files on NAS shares, or delete the shares (see [NAS Configuration on page 215](#)).
  - Delete backup images on OST logical storage units (LSUs), or delete the LSUs and storage servers (see [OST Configuration on page 257](#)).
  - Recycle (erase) tape cartridges on VTL partitions, or delete the partitions (see [VTL Configuration on page 231](#)).
2. Run space reclamation from the **Utilities > Space Reclamation** page (see [Space Reclamation on page 374](#)).
3. Make sure all replication and backup jobs are completed (see [Replication on page 138](#)).
4. On the **Secure Shred** page, click **Start Shred**.  
A warning message displays.
5. Click **Yes**.  
The system reboots and begins the secure shred process. This process can take multiple days to complete.
6. To check the status of secure shred, log onto the DXi6900 to view the limited **Secure Shred Mode** interface (see [Figure 245 on the next page](#)).
  - The **Secure File Shred Log** displays details about the secure shred progress. Click **Hide** to hide the log.
  - To cancel the secure shred process, click **Cancel**. The DXi reboots and resumes normal operation.
  - When the secure shred process is complete, the **Reboot** button displays.

---

**i Note:** You must log on as an Admin user to cancel secure shred or reboot the system.

**Figure 245:** Secure Shred Mode Interface

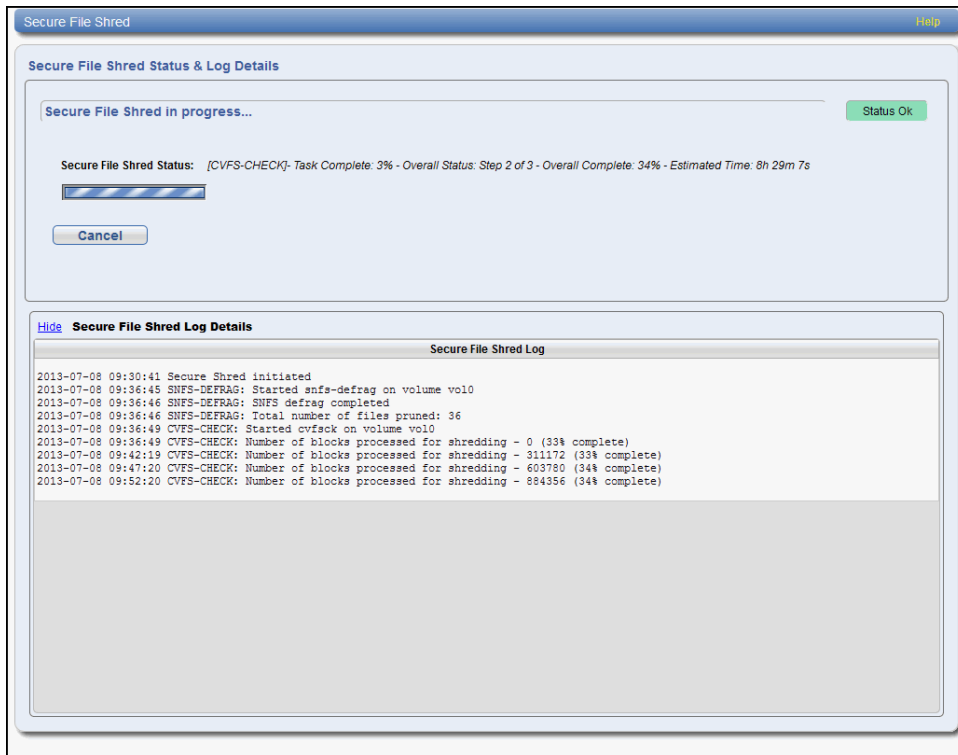

7. Click **Reboot** to finalize the secure shred process and reboot the DXi.  
After the DXi finishes rebooting, you can resume normal system operation.

---

## Software Upgrades

Software upgrades allow you to update the software running on the DXi6900 to the latest version. Software upgrades can include new features as well as bug fixes.

### Additional Information

- The latest version of DXi Software available for the DXi6900 is 3.2.2.1.
- DXi 3.2.4.1 Software is for the DXi6900-S only.
- Software upgrades on the DXi6900-S system are by software upload only.

There are two methods for upgrading the DXi software:



---

### Check for an upgrade (Home page)

(DXi6900) The DXi can automatically check for software upgrades on the **Home** page, or you can manually perform an upgrade check (see [Checking For Software Upgrades \(DXi6900\) below](#)). If an upgrade is found, you can choose to download and install it.

This is the recommended method for upgrading, but it requires that the DXi be able to access the Internet.

 **Caution:** Configure your firewall so that the DXi can send data to and received data from updates.quantum.com using port 80 (HTTP).

---

### Upload a software upgrade file (Software Upgrade page)

(DXi6900, DXi6900-S) You can download a software upgrade file from the Quantum Service and Support Web site and then manually upload it to the DXi using the **Software Upgrade** page (see [Uploading a Software Upgrade File \(DXi6900, DXi6900-S\) on page 389](#)).

You can use this method if the DXi cannot access the Internet.

 **Note:** Uploading a software upgrade file may be useful if you are upgrading multiple DXi systems, as the file only needs to be downloaded once. Also, this method assures that all systems will be running the same software version following the upgrade.

---

## Software Upgrades to DXi 3.2 Software and Higher

Software upgrades to DXi 3.2 Software and higher disable the following DXi user accounts:

- GUI Monitor
- CLI Administrator
- CLI Viewer
- Service GUI

After the upgrade is complete, the GUI Administrator must enable these accounts and set passwords (see [Security on page 335](#)).

## Checking For Software Upgrades (DXi6900)

The **Software Upgrade Utility** (accessible from the **Home** page) allows you to check for available DXi software upgrades and, if available, download and install them. You can also configure the DXi6900 to automatically check for software upgrades.

---

 **Note:** To check for and download software upgrades, the DXi must be able to access the Internet. If the DXi cannot access the Internet, see [Uploading a Software Upgrade File \(DXi6900, DXi6900-S\) on page 389](#).

To access the **Software Upgrade Utility**, click **Home** on the main menu, and then click the **Software Upgrade** link (see [Figure 246 below](#)).

**Figure 246:** Software Upgrade Utility

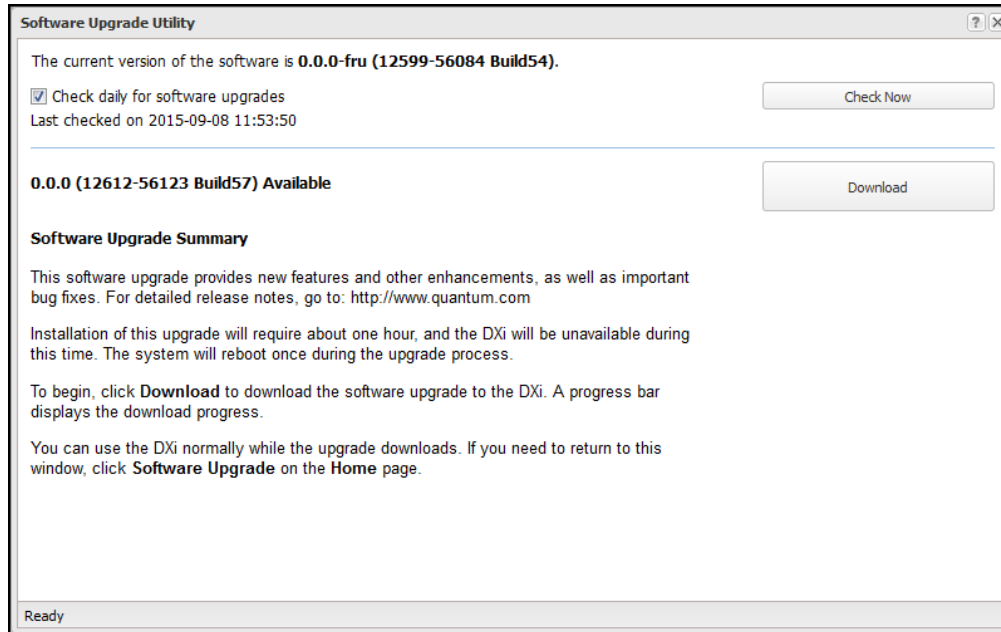

## Tasks

Use the **Software Upgrade Utility** to perform the following tasks:

- Configure the DXi6900 to automatically check for software upgrades (see [Automatically Checking for Upgrades below](#)).
- Manually check for software upgrades (see [Manually Checking for Upgrades on the next page](#)).
- Download and install available software upgrades (see [Downloading and Installing Upgrades on the next page](#)).

## Automatically Checking for Upgrades

The DXi6900 can automatically check for available software upgrades on a daily basis. If a software upgrade is found, you will be notified by an admin alert as well as by a Quick Tip icon on the **Home** page, next to the current software version (see [Figure 247 on the next page](#)).

On the **Software Upgrade Utility**, select the **Check daily for software upgrades** check box to enable automatic upgrade checking. Automatic upgrade checking is enabled by default. To disable automatic upgrade checking, clear the **Check daily for software upgrades** check box (not recommended).

**Figure 247:** Home Page - Software Upgrade Available

Hostname	CrystalBlue
IP Address	10. [REDACTED]
Version	2.3.1 (11036-52992 Build15) 
Serial Number	SV [REDACTED]
Data-at-Rest Encryption	Enabled
<a href="#">Software Upgrade</a>	

### Manually Checking for Upgrades

To check for available software upgrades at any time, on the **Software Upgrade Utility**, click **Check Now**.

If a software upgrade is available, you can read information about the contents of the upgrade and, if you choose, download and install it.

### Downloading and Installing Upgrades

If a software upgrade is available (after automatically or manually checking for upgrades), a summary describing the upgrade displays on the **Software Upgrade Utility**.

To download and install an available software upgrade:

1. On the **Software Upgrade Utility**, click **Download**.

The bottom status bar displays download progress. It will take several minutes to download the upgrade, depending on network speeds. You can use the DXi normally while the upgrade downloads. If you need to return to this window, click **Software Upgrade** on the **Home** page.

When the download is complete, a list of pre-upgrade actions displays (see [Figure 248 on the next page](#)). These are important actions you should take prior to installing the upgrade.

**Figure 248:** Software Upgrade Utility - Software Upgrade Downloaded

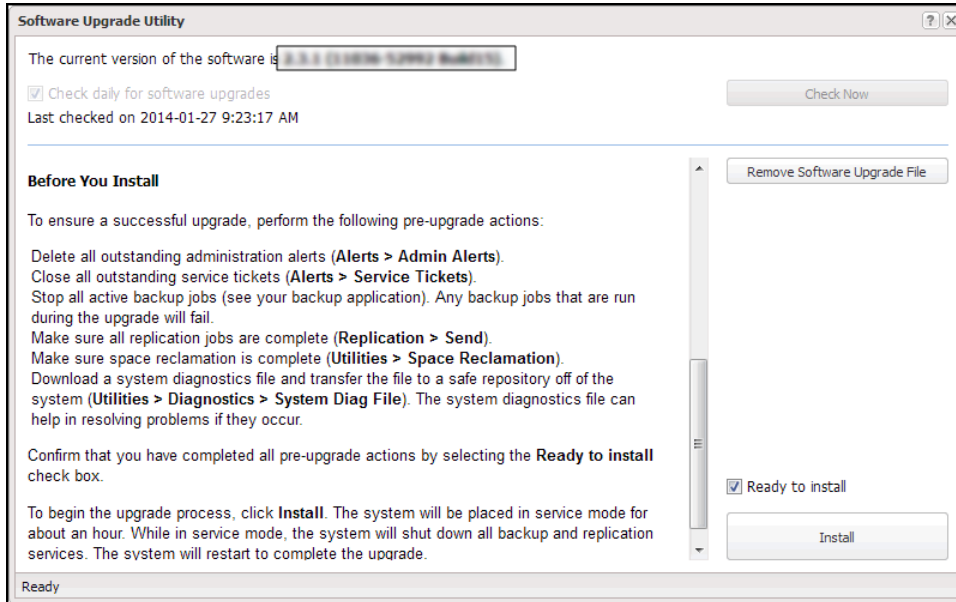

2. To ensure the system is healthy before upgrading, read and follow the instructions in each of the pre-upgrade actions. The pre-upgrade actions can differ depending on the type of upgrade, but typical actions include the following:

- Address and delete all outstanding administration alerts (see [Admin Alerts on page 206](#)).
- Resolve and close all outstanding service tickets (see [Service Tickets on page 207](#)).

---

**Note:** Quantum recommends taking the following actions before upgrading.

- Stop all active backup jobs (see your backup application). Any backup jobs that are run during the upgrade will fail.
- Make sure all replication jobs are complete (see [Replication on page 138](#)). If replication or synchronization jobs are nearly complete, Quantum recommends allowing them to complete before upgrading.
- Make sure space reclamation is complete (see [Space Reclamation on page 374](#)). If space reclamation is nearly complete, Quantum recommends allowing it to complete before upgrading.
- Download a system diagnostics file and transfer the file to a safe repository off of the DXi (see [System Diag File on page 367](#)). The system diagnostics file can help in resolving problems if they occur.

3. Confirm that you have completed all pre-upgrade actions by selecting the **Ready to install** check box.

---

**Note:** The **Ready to install** check box and the **Install** button are disabled if there are any outstanding administration alerts or service tickets.

4. To begin the upgrade process, click **Install**.

Read the onscreen information to learn what to expect during the upgrade. The bottom status bar displays installation progress, and a message displays if a reboot is required.

Depending on the type of upgrade, the DXi may be placed in service mode for about an hour. While in service mode, the system will shut down all backup and replication services. If necessary, the DXi will restart one or more times to complete the upgrade.

---

**i Note:** If you decide not to install the software upgrade after downloading it, click **Remove Software Upgrade File** to remove the current download from the DXi.

Clear your Web browser cache before logging on to the remote management console for the first time following the software upgrade. This will ensure the remote management console displays correctly.

## Uploading a Software Upgrade File (DXi6900, DXi6900-S)

The **Software Upgrade** page allows you to upload and install a software upgrade file on the DXi6900. Use this upgrade method if the DXi cannot access the Internet.

Before you begin, download the software upgrade file on a computer connected to the Internet, and then copy the software upgrade file (.fw) to the computer you will use to access the DXi remote management console. You can download the software upgrade file and release notes from the Quantum Service and Support Web site:

<http://www.quantum.com/ServiceandSupport/Index.aspx>

To access the **Software Upgrade** page, click the **Utilities** menu, and then click the **Software Upgrade** tab (see [Figure 249 below](#)).

**Figure 249:** Software Upgrade Page

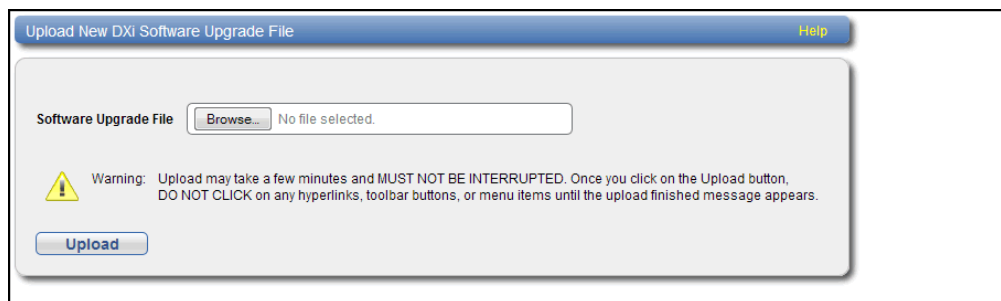

To upload a software upgrade file:

1. Click the **Browse** button to browse the system and locate the software upgrade file.
2. Click **Upload**.
3. Click **Start** to begin the upload process.

Do not close the window until the uploading and unpacking process is complete. An **Information** message displays stating the software upgrade file was uploaded successfully.

4. Click **OK**.

The **Software Upgrade** page indicates that a software upgrade file has been uploaded (see [Figure 250 below](#)).

**Figure 250:** Software Upgrade Page - Software Upgrade File Uploaded

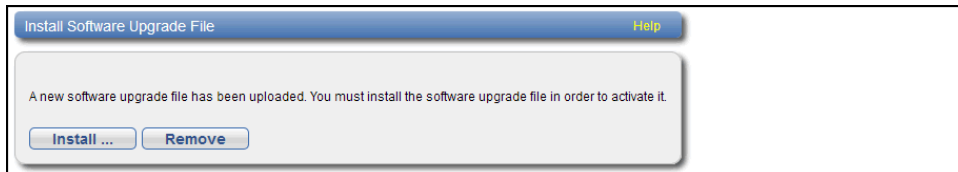

5. Click **Install**.

### Additional Information

- If necessary, click the link to delete any outstanding administration alerts before proceeding.
- If you decide not to install the software upgrade file after uploading it, click **Remove** on the **Utilities > Software Upgrade** page to remove the uploaded software upgrade file from the DXi.

The **Software Upgrade Utility** displays (see [Figure 251 below](#)).

**Figure 251:** Software Upgrade Utility - Software Upgrade File Uploaded

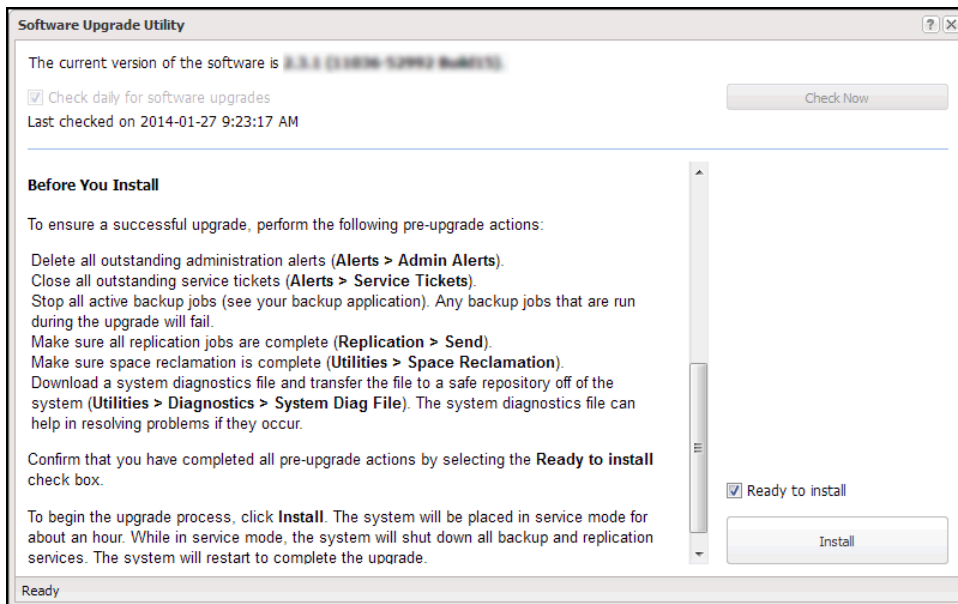

6. To ensure the system is healthy before upgrading, read and follow the instructions in each of the pre-upgrade actions. The pre-upgrade actions can differ depending on the type of upgrade, but typical actions include the following:
  - Address and delete all outstanding administration alerts (see [Admin Alerts on page 206](#)).
  - Resolve and close all outstanding service tickets (see [Service Tickets on page 207](#)).

---

**i Note:** Quantum recommends taking the following actions before upgrading.

- Stop all active backup jobs (see your backup application).
  - Make sure all replication jobs are complete (see [Replication on page 138](#)). If replication or synchronization jobs are nearly complete, Quantum recommends allowing them to complete before upgrading.
  - Make sure space reclamation is complete (see [Space Reclamation on page 374](#)). If space reclamation is nearly complete, Quantum recommends allowing it to complete before upgrading.
  - Download a system diagnostics file and transfer the file to a safe repository off of the DXi (see [System Diag File on page 367](#)). The system diagnostics file can help in resolving problems if they occur.
7. After you have completed all pre-upgrade actions, confirm that you are ready to continue by selecting the **Ready to install** check box.

---

**i Note:** The **Ready to install** check box and the **Install** button are disabled if there are any outstanding administration alerts or service tickets.

8. To begin the upgrade process, click **Install**.

Read the on-screen information to learn what to expect during the upgrade. The bottom status bar displays installation progress, and a message displays if a reboot is required.

Depending on the type of upgrade, the DXi may be placed in service mode for about an hour. While in service mode, the system will shut down all backup and replication services. If necessary, the DXi will restart one or more times to complete the upgrade.

### Important - Clear Your Web Browser Cache

It is important to clear your Web browser cache before logging on to the remote management console for the first time following the software upgrade. This will ensure the remote management console displays correctly.

---

## Reboot & Shutdown

The **Reboot & Shutdown** page allows you to reboot or shut down the DXi6900.

To access the **Reboot & Shutdown** page, click the **Utilities** menu, and then click the **Reboot & Shutdown** tab (see [Figure 252 below](#)).

**Caution:** Before shutting down the DXi6900, make sure that all backup and replication jobs (as source and target) are finished, and that space reclamation activity is complete.

**Figure 252:** Reboot & Shutdown Page

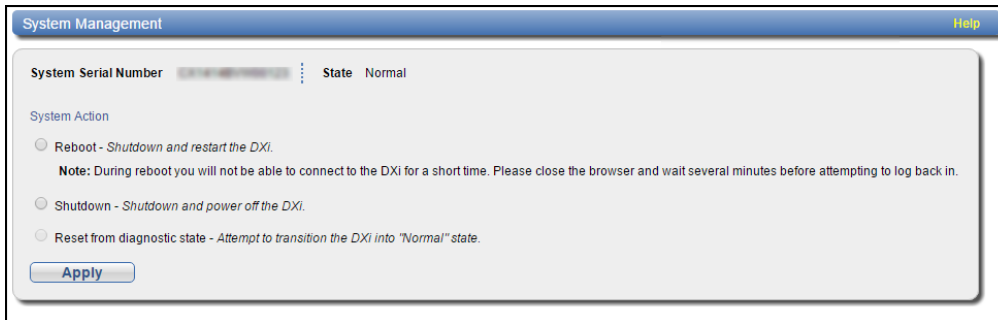

To reboot or shutdown the DXi6900:

1. Under **System Action**, select an option:

<b>Reboot</b>	Reboots the DXi6900.  Rebooting the system closes the Web browser connection. You must log on again after the system has rebooted.
<b>Shutdown</b>	Shuts down the DXi6900.
<b>Reset from diagnostic state</b>	(Only available when the node is in degraded mode) Restarts the services on the node without rebooting the system.

2. Click **Apply**.
3. Close the browser window.

### DXi Shutdown Time

Shutting down the system can take up to 15 minutes. Only the node will completely shut down. When rebooting, the system can take approximately 30 minutes to start up, depending on the amount of installed storage capacity.





# Chapter 11: System Specifications

---

This chapter lists specifications of the DXi6900. Refer to the following sections:

DXi6900 Physical Characteristics .....	393
DXi6900 Environmental Specifications .....	403

---

## DXi6900 Physical Characteristics

The following tables provide dimensions and other physical characteristics of the DXi6900 system components:

- [DXi6900 G1 Physical Characteristics on the next page](#)
- [DXi6900 G2 Physical Characteristics on the next page](#)
- [DXi6900-S Physical Characteristics on the next page](#)
- [DXi6900 Storage Capacity on page 395](#)
- [DXi6900 Cable Drops on page 396](#)
- [Virtual Device Limits and Hardware Interfaces on page 398](#)
- [DXi6900 G1 Power Requirements on page 399](#)
- [DXi6900 G2 Power Requirements on page 400](#)
- [DXi6900-S Power Requirements on page 401](#)

## DXi6900 G1 Physical Characteristics

	DXi6900 G1 Node	Array Module (RBOD)	Expansion Module (EBOD)
<b>Height</b>	2U, 3.4 inches (8.7 cm)	2U, 3.4 inches (8.7 cm)	2U, 3.4 inches (8.7 cm)
<b>Width (side to side)</b>	17.5 inches (44.4 cm)	17.8 inches (45.1 cm)	17.6 inches (44.6 cm)
<b>Depth (front to back)</b>	28.6 inches (72.6 cm)	21.8 inches (55.2 cm)	21.8 inches (60.2 cm)
<b>Weight (stand alone)</b>	53.0 pounds (24.0 kg)	59.0 pounds (26.8 kg)	57.0 pounds (25.9 kg)
<b>Rack Space Required</b>	2U	2U	2U
<b>Air clearance</b>	Open 4 in (10.2 cm) behind unit for proper air flow		

## DXi6900 G2 Physical Characteristics

	DXi6900 G2 Node	Array Module (RBOD)	Expansion Module (JBOD)
<b>Height</b>	2U, 3.4 inches (8.7 cm)	2U, 3.4 inches (8.7 cm)	2U, 3.4 inches (8.7 cm)
<b>Width (side to side)</b>	17.5 inches (44.4 cm)	17.8 inches (45.1 cm)	17.6 inches (44.6 cm)
<b>Depth (front to back)</b>	28.6 Inches (72.6 cm)	21.8 inches (55.2 cm)	21.8 inches (60.2 cm)
<b>Weight (stand alone)</b>	49.4 pounds (22.4 kg)	59.0 pounds (26.8 kg)	57.0 pounds (25.9 kg)
<b>Rack Space Required</b>	2U	2U	2U
<b>Air clearance</b>	Open 4 in (10.2 cm) behind unit for proper air flow		

## DXi6900-S Physical Characteristics

	DXi6900-S Node	Array Module (RBOD)	Expansion Module (JBOD)
<b>Height</b>	2U, 3.4 inches (8.7 cm)	2U, 3.4 inches (8.7 cm)	2U, 3.4 inches (8.7 cm)
<b>Width (side to side)</b>	17.5 inches (44.4 cm)	17.8 inches (45.1 cm)	17.6 inches (44.6 cm)

	DXi6900-S Node	Array Module (RBOD)	Expansion Module (JBOD)
<b>Depth (front to back)</b>	28.6 inches (72.6 cm)	21.8 inches (55.2 cm)	21.8 inches (60.2 cm)
<b>Weight (stand alone)</b>	44.5 pounds (20.2 kg)	57 pounds (25.9 kg)	55 pounds (24.9 kg)
<b>Rack Space Required</b>	2U	2U	2U
<b>Air clearance</b>	Open 4 in (10.2 cm) behind unit for proper air flow		

## DXi6900 Storage Capacity

DXi6900 Storage Capacity	
<b>DXi6900 G1 / DXi6900 G2</b>	
<b>Usable capacity</b>	From 17 TB to 510 TB
<b>Capacity increments</b>	Each Array Module (RBOD) and Expansion Module (EBOD) provides 34 TB of usable capacity, licensable in 17 TB increments.
<b>DXi6900-S</b>	
<b>Usable capacity</b>	From 34 TB to 544 TB
<b>Capacity increments</b>	Each Array Module (RBOD) and Expansion Module (EBOD) provides 68 TB of usable capacity, licensable in 34 TB increments.

# DXi6900 Cable Drops

## DXi6900 Cable Drops

### Ethernet Cable Drops

**DXi6900 G1 (3 x 1GbE ports and 2 x 10GbE ports)** - 1 to 3 1GbE Ethernet connections and 1 to 2 10GbE Ethernet connections (optical or Twinax, see below) for NAS or OST connectivity, replication, and remote management.

**DXi6900 G1 (7 x 1GbE ports and 2 x 10GbE ports)** - 1 to 7 1GbE Ethernet connections and 1 to 2 10GbE Ethernet connections (optical or Twinax, see below) for NAS or OST connectivity, replication, and remote management.

**DXi6900 G1 (3 x 1GbE ports and 4 x 10GbE ports)** - 1 to 3 1GbE Ethernet connections and 1 to 4 10GbE Ethernet connections (optical or Twinax, see below) for NAS or OST connectivity, replication, and remote management.

**DXi6900 G2 / DXi6900-S (3 x 1GbE ports)** - 1 to 3 1GbE Ethernet connections for for NAS or OST connectivity, replication, and remote management.

**DXi6900 G2 / DXi6900-S (6 x 10GbE ports)** - 1 to 6 10GbE Ethernet connections (optical, Twinax, CAT6, see below) for NAS or OST connectivity, replication, and remote management.

**i Note:** For Cisco 5000 Series Data Center Class switches, Quantum recommends using the approved 5 meter Twinax cable type that is shipped with the DXi6900 system. Otherwise, Quantum recommends using optical (SFP+) connectivity.

**i Note:** The 10 GbE Copper (Twinax) cable options that Quantum provides do not support all switches. Please note the supported switches during the purchase-configuration process, and if the Twinax cables supplied by Quantum are *not* compatible with your switch, then you will need to provide your own compatible Twinax cables from your switch vendor. Be sure to have these available before the system installation takes place.

### DXi6900 Cable Drops

#### Ethernet Cables

#### 10 GbE Optical Cable (DXi6900 G1)



#### 10 GbE Optical Cable (DXi6900 G2 / DXi6900-S)



#### 10 GbE Copper (Twinax) Cable



#### 10 GBase-T CAT6 Cable



---

#### Fibre Channel Drops

1 to 6 Fibre Channel connections for path-to-tape/VTL data transfer.

---

#### Power Outlets

**Node** - 2 USA type 3-prong power outlets (**Nema 5-15**) or 2 C13 type 3-prong power outlets (**IEC320 C13**).

**Expansion Module (each)** - 2 USA type 3-prong power outlets (**Nema 5-15**) or 2 C13 type 3-prong power outlets (**IEC320 C13**). For additional information, see [on page 393](#).

---

# Virtual Device Limits and Hardware Interfaces

## DXi6900 Virtual Device Limits and Hardware Interfaces

### Interfaces

**VTL backup target:** 64 partitions maximum, 512 virtual tape drives (VTDs) maximum.

**NAS backup target:** 128 shares maximum (NFS or CIFS)

**OST backup target:** 100 storage servers maximum

**Note:** NFS version: NFSv3

**Note:** Samba version: 4.1.12

### Hardware

#### DXi6900 G1

- 3 ports 100/1000BASE-T Ethernet (RJ45 connector)
- 2 ports 10GbE Ethernet (optical 10GBASE-SR via LC connector or Twinax copper 10GBASESFP+Cu via SFP+)
- 6 ports 8 Gb Fibre Channel (LC connector)

**Note:** An optional network adapter may be added providing 4 additional 100/1000BASE-T Ethernet ports or 2 additional 10GbE Ethernet ports.

#### DXi6900 G2 / DXi6900-S

- 3 ports 100/1000BASE-T Ethernet (RJ45 connector)
- 1 to 6 ports 10GbE Ethernet (optical 10GBASE-SR via LC connector, Twinax copper 10GBASESFP+Cu via SFP+, or 10GBASE-T via CAT6A)
- 1 to 6 ports 16 Gb Fibre Channel (LC connector)

# DXi6900 G1 Power Requirements

## DXi6900 G1 Power Requirements

**Power Supplies and Cords**

Node  
 Expansion Module (RBOD)

Two (2) hot-swappable redundant power supplies

Two (2) USA type 3-prong power cords with **IEC320 C13** to **Nema 5-15** connectors:



Two (2) C13 to C14 type 3-prong power cords with **IEC320 C13** to **IEC320 C14** connectors:



<b>Voltage</b>	Node	100–240 VAC
	Expansion Module (RBOD)	100–240 VAC
<b>Frequency</b>	Node	50–60Hz
	Array Module (RBOD)	50–60Hz
	Expansion Module (EBOD)	50–60Hz

<b>Average AC Current</b>	Node	586 Watts, 5.9A @100 VAC 2100 BTU/hr 586 Watts, 2.3A @240 VAC 2100 BTU/hr
	Array Module (RBOD)	334 Watts, 3.3A @100 VAC 1140 BTU/hr 334 Watts, 1.4A @240 VAC 1140 BTU/hr
	Expansion Module (EBOD)	228 Watts, 2.3A @100 VAC 780 BTU/hr 228 Watts, 1.0A @240 VAC 780 BTU/hr
<b>Inrush Peak AC Current</b>	Maximum Configuration	81A @ 100 VAC 34A @ 240 VAC

## DXi6900 G2 Power Requirements

### DXi6900 G2 Power Requirements

#### Power Supplies and Cords

Node	Two (2) hot-swappable redundant power supplies
Expansion Module (RBOD)	Two (2) USA type 3-prong power cords with <b>IEC320 C13</b> to <b>Nema 5-15</b> connectors:



Two (2) C13 to C14 type 3-prong power cords with **IEC320 C13** to **IEC320 C14** connectors:







<b>Voltage</b>	Node	100–240 VAC
	Expansion Module (RBOD)	100–240 VAC
<b>Frequency</b>	Node	50–60Hz
	Array Module (RBOD)	50–60Hz
	Expansion Module (EBOD)	50–60Hz
<b>Average AC Current</b>	Node	613 Watts, 6.1A @100 VAC 2000 BTU/hr
		613 Watts, 2.6A @240 VAC 2000 BTU/hr
	Array Module (RBOD)	334 Watts, 3.3A @100 VAC 1140 BTU/hr
		334 Watts, 1.4A @240 VAC 1140 BTU/hr
	Expansion Module (EBOD)	228 Watts, 2.3A @100 VAC 780 BTU/hr
		228 Watts, 1.0A @240 VAC 780 BTU/hr
<b>Inrush Peak AC Current</b>	Maximum Configuration	95A @ 100 VAC 40A @ 240 VAC

**⚠ Caution:** To safeguard backups and to avoid potential data loss in the event of a power outage, Quantum recommends that you connect the DXi6900 to an uninterruptable power supply (UPS) with a minimum UPS capacity rating that meets the power requirements stated above.

## DXi6900-S Power Requirements

### DXi6900-S Power Requirements

<b>Power Supplies and Cords</b>	Node	Two (2) hot-swappable redundant power supplies
	Expansion Module (RBOD)	Two (2) USA type 3-prong power cords with <b>IEC320 C13</b> to <b>Nema 5-15</b> connectors:
		
		Two (2) C13 to C14 type 3-prong power cords with <b>IEC320 C13</b> to <b>IEC320 C14</b> connectors:
		
<b>Voltage</b>	Node	100–240 VAC
	Expansion Module (RBOD)	100–240 VAC
<b>Frequency</b>	Node	50–60Hz
	Array Module (RBOD)	50–60Hz
	Expansion Module (EBOD)	50–60Hz

<b>Average AC Current</b>	Node	468 Watts, 4.7A @100 VAC 1597 BTU/hr 468 Watts, 1.9A @240 VAC 1597 BTU/hr
	Array Module (RBOD)	276 Watts, 2.8A @100 VAC 942 BTU/hr 276 Watts, 1.2A @240 VAC 942 BTU/hr
	Expansion Module (EBOD)	168 Watts, 1.8A @100 VAC 780 573 BTU/hr 168 Watts, 0.8A @240 VAC 780 573 BTU/hr
	Maximum Configuration	59A @ 100 VAC 25A @ 240 VAC

# DXi6900 Environmental Specifications

## DXi6900 Environmental Specifications

### DXi6900 Climatic Environment

<b>Temperature</b>	<i>Operating</i>	10° to 35°C (50° to 95°F) with a maximum temperature gradient of 10°C per hour  <b>i Note:</b> 35°C (95°F) is the maximum temperature for the DXi6900 at sea level. For every 1,000 feet (305 meters) of altitude, the maximum temperature is reduced by 0.9°C.
	Shipping and storage	–20° to 60°C (4° to 140°F) with a maximum temperature gradient of 20°C per hour
<b>Relative humidity</b>	<i>Operating</i>	20% to 80% (non-condensing) with a maximum humidity gradient of 10% per hour
	Shipping and storage	5% to 95% (non-condensing) with a maximum humidity gradient of 10% per hour
<b>Altitude</b>	<i>Operating</i>	–16m to 3048 m (–50 to 10,000 ft)
	Shipping and storage	–16m to 10,600 m (–100 to 35,000 ft)

### DXi6900 Vibration and Shock

<b>Sine Vibration</b>	Operating	Random 0.26 G's, 5–350 Hz, Operational axis 10 minutes, psd: 0.0002 G <sup>2</sup> /Hz
	Non-operating	Random 0.5 G's, 5–350 Hz, Operational axis 10 minutes, psd: 0.0007 G <sup>2</sup> /Hz
<b>Shock Vibration</b>	Operating	2 G's for 11 ms, half-sine input, 3 shock pulses in both + and – directions operational axis
	Non-operating	3.5 G's for 11 ms, half-sine input, 3 shock pulses in both + and – directions operational axis

**DXi6900 Acoustic**

<b>Acoustic output</b>	Operating	Sound Pressure Level 72 dbA maximum at any operation position
------------------------	-----------	---

**DXi6900 Agency Approvals**

<b>EMC/Safety</b>	47 CFR part 15 Class A CNS 13438 Class A CISPR 22 Class A CISPR 24 Class A EN 55022 Class A EN 55024 EN 60590-1 EN 61000-3-2 EN 61000-3-3 IEC 60590-1 ICES-003 Class A VCCI V-3/2011-04 Class A (DXi6900 G1) VCCI V-3/2014-04 Class A (DXi6900 G2 / DXi6900-S) AS/NZS 3548 Class A KN22 Class A KN24 UL 60590-1
<b>Immunity Tests</b>	IEC 61000-4-2 (Ed. 2.0 2008-12) - Electrostatic Discharge (ESD) IEC 61000-4-3 (Ed. 3.1 2008-04) - Radiated RF Immunity Standards: IEC 61000-4-4 (Ed. 2.0 2004-07) - Electrical Fast Transient/Burst EN55024: 1998 IEC 61000-4-5 (Ed. 2.0 2005-11) - Surge Immunity +A1: 2001 IEC 61000-4-6 (Ed. 2.2 2006-05) - Conducted RF Immunity +A2:2003 IEC 61000-4-8 (Ed. 1.1 2001-03) - Magnetic Field KN24 IEC 61000-4-11 (Ed. 2.0 2004-03) - AC Dips and Interrupts



# Chapter 12: Troubleshooting

---

This chapter describes the status and problem reporting features of the DXi6900 as well as problems you might encounter during setup and operation of the system. Corrective information is provided to help you resolve these problems.

For information about troubleshooting the DXi6900, see the following sections:

DXi6900 Status and Problem Reporting .....	405
General Troubleshooting .....	406
Common Problems and Solutions .....	407

---

## DXi6900 Status and Problem Reporting

To maintain system health and help you identify and correct problems that occur, the DXi6900 constantly performs the following actions:

- To maintain system health and help you identify and correct problems that occur, the DXi6900 constantly performs the following actions:
- Monitors the system software and hardware components.
- Detects system problems.
- Attempts to isolate each problem to a specific field replaceable component.
- Attempts to recover from the problem.
- Logs the problem.

- If the problem requires service, the system reports the problem in a service ticket associated with the field replaceable component.

---

## General Troubleshooting

For information about general troubleshoot actions you can take, see the following sections:

- [Viewing Service Tickets below](#)
- [Checking Hardware Status below](#)
- [Downloading a System Diagnostics File on the next page](#)

### Viewing Service Tickets

Service tickets include time and date information, status (open or closed), information about each error, and links to recommended troubleshooting procedures. The DXi6900 generates service tickets according to the following scenarios:

- If the component associated with the problem does not have an open service ticket, the DXi6900 opens a service ticket for the component and reports the problem in a service ticket.
- If the problem reoccurs, the DXi6900 logs the number of times that it detects the problem in the existing report.
- If a different problem occurs with the same component, the DXi6900 adds a new report to the same service ticket.
- If a problem occurs with a different component, the DXi6900 uses the above scenario to open a new service ticket for the component or report the problem in an existing service ticket associated with the component.

To access the **Service Tickets** page, click the **Alerts** menu, and then click the **Service Tickets** tab.

For more information about working with service tickets, see [Service Tickets on page 207](#).

### Checking Hardware Status

The **Hardware** page allows you to view information about the hardware components of the DXi6900. You can view the overall status of the node as well as detailed status information for components such as the system board, Fibre Channel adapters, network ports and storage arrays.

To access the **Hardware** page, click the **Status** menu, and then click the **Hardware** tab.

For information about using the **Status** page, see [Hardware on page 174](#).

## Downloading a System Diagnostics File

The **System Diag File** page allows you to generate and download a system diagnostics file. This file contains the diagnostic logs for all of the system components.

To access the **System Diag File** page, on the **Diagnostics** page, click the **System Diag File** tab.

For information about downloading the system diagnostics file, see [System Diag File on page 367](#).

---

## Common Problems and Solutions

The troubleshooting information in this section covers the following topics:

- [Start-up Problems below](#)
- [Hardware Problems below](#)
- [Ethernet Network Problems on page 409](#)
- [Replication Problems on page 410](#)
- [Temperature Problems on page 410](#)

### Start-up Problems

[Table 1 below](#) describes problems that can occur during system start-up.

**Table 1:** Start-up Problems

Problem	Corrective Action
FATAL ERROR Unable to start SNFS! Message displays.	Contact your Quantum Customer Support representative (see <a href="#">Getting More Information or Help</a> ).
FATAL ERROR Unable to start blockpool! Message displays.	Contact your Quantum Customer Support representative (see <a href="#">Getting More Information or Help</a> ).

### Hardware Problems

[Table 1 on the next page](#) describes corrective actions for problems occurring with the system hardware.

**Table 1:** Hardware Problems

Problem	Corrective Action
The system does not power on.	Make sure the power cords are connected to a grounded electrical outlet and the power switches located on the back of the power supplies are on. If the problem persists, contact your Quantum Customer Support representative to arrange for service (see <a href="#">Getting More Information or Help</a> ).
One power supply is not functioning.	Determine which power supply has failed by observing the fault LED on the power supply. Contact your Quantum Customer Support representative to arrange for service (see <a href="#">Getting More Information or Help</a> ).
Both power supplies are not functioning.	Determine which power supply has failed by observing the fault LED on the power supply. Contact your Quantum Customer Support representative to arrange for service (see <a href="#">Getting More Information or Help</a> ).
One fan is not operating.	Determine which fan has failed by reading the service ticket generated by the system. Contact your Quantum Customer Support representative to arrange for service (see <a href="#">Getting More Information or Help</a> ).
Multiple fans are not operating.	 <b>Caution:</b> Turn the system off immediately! The system will overheat with multiple fans not operating. Contact your Quantum Customer Support representative to arrange for service (see <a href="#">Getting More Information or Help</a> ).
A hard drive is not responding	Determine which drive has failed by observing the fault LED on the drive carrier. Contact your Quantum Customer Support representative for a drive carrier replacement (see <a href="#">Getting More Information or Help</a> ).
A SAS cable is removed during normal operation.	The system will shut down as soon as it recognizes the problem. There is a potential for data loss. Power off the system, re-insert the SAS cable and restart the system. Depending on the state of the system when the SAS cable was removed, a long-running, mandatory data verification may occur.



# Ethernet Network Problems

[Table 1 below](#) describes corrective actions for problems occurring with the Ethernet network.

**Table 1:** Ethernet Network Problems

Problem	Corrective Action
The Ethernet link light on the DXi6900 is not lit when a cable is connected to a hub or switch.	Check to make sure the Ethernet cable is not a cross-over cable. Use only “straight” CAT-6 Ethernet cables. Port on the hub or switch is not active or damaged. Port on the DXi6900 is damaged. Contact the Quantum Customer Support department (see <a href="#">Getting More Information or Help</a> ).
The Ethernet link light on the switch or hub is not lit when a cable is connected to DXi6900 system.	Check to make sure the Ethernet cable is not a cross-over cable. Use only “straight” CAT-6 Ethernet cables. Port on the hub or switch is not active or damaged. Port on the DXi6900 is damaged. Contact the Quantum Customer Support department (see <a href="#">Getting More Information or Help</a> ).
DXi6900 system is not visible on the Ethernet network.	Try to ping the DXi6900 system IP address from a host on the same network. If the ping reports round trip times, the DXi6900 system is active. If not, check the cables, switches, or hubs for damaged components. If everything checks out, contact the Quantum Customer Support department (see <a href="#">Getting More Information or Help</a> ).
DXi6900 remote management pages are not visible.	IF you cannot connect to the DXi6900 remote management pages, verify that the following network settings for the DXi6900 are correct: <ul style="list-style-type: none"><li>• Hostname</li><li>• IP addresses</li><li>• Default gateway</li><li>• Subnet mask</li><li>• Domain name (optional)</li></ul>
An Ethernet cable is removed during normal operation.	The system will discontinue use of the associated Ethernet port. A Service ticket will be issued. The possibility of errors exist; data corruption will not occur. Reconnect the cable as soon as possible. It is not necessary to power the system off. Depending on the state of the system when the Ethernet cable was removed, replication, system management, or ingest may need to be restarted.

## Replication Problems

[Table 1 below](#) describes corrective actions for problems occurring with the replication.

**Table 1:** Replication Problems

Problem	Explanation/Corrective Action
The replication was paused, but the replication is still in process.	When you click <b>Pause</b> , the system will continue to replicate the current tag or block of information in process. The process of completing the current tag replication can take up to 15 minutes to complete. Once that tag has completed replication the system will pause and wait to resume.
The replication was paused and a <b>Failure</b> event was generated in the <b>Replication Events</b> page.	This is normal. When a replication is paused, a failure event is generated on the <b>Replication Events</b> page. The system will continue the replication when you click <b>Resume</b> .
Replication was disabled while a replication was in process and the replication completed.	If you click <b>Disable</b> during a replication in process, the system will complete the entire replication and then disable replication on the system. The system will be unable to replicate until you click <b>Enable</b> .
Enabled replication on a NAS share and received the following Event: No destination host is specified for replication.	You must configure the target system prior to configuring the source. If the target system is not configured first, you will not be able to designate the replication target.
Able to enable and schedule replication for NAS even though no target IP configured.	It is possible to enable and schedule a replication when a target system has not been configured. The replication will not start until a target system is configured.

## Temperature Problems

Temperature problems are generally caused by incorrect room temperature, poor air circulation inside the DXi6900 rack or components, or a malfunctioning cooling fan.

Use the following procedure if a temperature problem is reported:

1. Check the ambient temperature of the room containing the DXi6900 system to verify that the temperature falls within the specified range.
2. Inspect for adequate air circulation inside the rack. Some racks may provide additional fans to improve air circulations. Check the fan for proper operation. Clean or replace any air filter as necessary.
3. If a component reports a temperature problem, verify that the associated fan is operating correctly. If necessary, contact Quantum customer support to replace the fan (see [Getting More Information or Help](#)).