



# SANtricity® Storage Manager 11.4x Installing and Configuring for Linux® Express Guide

## StorNext QD7000

Firmware 8.40.xx.xx



SANtricity® Storage Manager 11.4x Installing and Configuring for Linux® Express Guide, 6-68664-01 Rev A, March 2018  
Product of USA.

Quantum Corporation provides this publication “as is” without warranty of any kind, either express or implied, including but not limited to the implied warranties of merchantability or fitness for a particular purpose. Quantum Corporation may revise this publication from time to time without notice.

#### **COPYRIGHT STATEMENT**

© 2018 Quantum Corporation. All rights reserved.

Your right to copy this manual is limited by copyright law. Making copies or adaptations without prior written authorization of Quantum Corporation is prohibited by law and constitutes a punishable violation of the law.

#### **TRAEMARK STATEMENT**

Artico, Be Certain (and the Q brackets design), DLT, DXi, DXi Accent, DXi V1000, DXi V2000, DXi V4000, GoVault, Lattus, NDX, the Q logo, the Q Quantum logo, Q-Cloud, Quantum (and the Q brackets design), the Quantum logo, Quantum Be Certain (and the Q brackets design), Quantum Vision, Scalar, StorageCare, StorNext, SuperLoader, Symform, the Symform logo (and design), vmPRO, and Xcellis are either registered trademarks or trademarks of Quantum Corporation and its affiliates in the United States and/or other countries. All other trademarks are the property of their respective owners.

Products mentioned herein are for identification purposes only and may be registered trademarks or trademarks of their respective companies. All other brand names or trademarks are the property of their respective owners.

Quantum specifications are subject to change.



# Preface

---

---

**Note:** The 8.40.xx.xx firmware (Madrid) is used in the QD7000 (E5600, Titan RAID controller, only). Refer to the [NetApp to Quantum Naming Decoder](#) section for additional information.

---

This section provides the following information:

- [Audience](#)
- [Prerequisites](#)
- [NetApp to Quantum Naming Decoder](#)
- [Product Safety Statements](#)
- [Contacts](#)
- [Comments](#)
- [Quantum Global Services](#)

---

## Audience

---

This manual is intended for storage customers and technicians.

## Prerequisites

Prerequisites for installing and using this product include knowledge of:



- Servers and computer networks
- Network administration
- Storage system installation and configuration
- Storage area network (SAN) management and direct attach storage (DAS)
- Fibre Channel (FC) and Ethernet protocols



## NetApp to Quantum Naming Decoder

Use [Table 1](#) to correlate the NetApp product nomenclature to the equivalent Quantum-storage naming conventions.

Table 1 Product Nomenclature

<b>E-Series NetApp Product</b>	<b>Quantum-Storage</b>	<b>Description</b>
Controller-Drive Tray	Base System	Quantum uses Base System when referring to a drive tray with the RAID controllers.
Drive Tray	Expansion Unit	Quantum uses Expansion Unit when referring to a drive tray with the environmental services modules (ESMs).
E5600 (Code Name: Titan)	RAID Controller	Four 16Gb/s FC SFP+ host ports
E5500 (Code Name: Soyuz)	RAID Controller	Four 16Gb/s FC SFP+ host ports
E5400 (Code Name: Pikes Peak)	RAID Controller	Four 8Gb/s FC SFP+ host ports
DE6600 (Code Name: Wembley)	4U 60-drive enclosure	Sixty 3.5 inch disk drives

E-Series NetApp Product	Quantum-Storage	Description
<p>E5660</p> <ul style="list-style-type: none"> <li>• DE6600 4U drive enclosure</li> <li>• With E5600 RAID controllers (Titan)</li> </ul>	<p>Quantum StorNext QD7000</p>	
<p>E5560</p> <ul style="list-style-type: none"> <li>• DE6600 4U drive enclosure</li> <li>• With E5500 RAID controllers (Soyuz)</li> </ul>	<p>Quantum StorNext QD7000</p>	
<p>E5460</p> <ul style="list-style-type: none"> <li>• DE6600 4U drive enclosure</li> <li>• With E5400 RAID controllers (Pikes Peak)</li> </ul>	<p>Quantum StorNext QD6000</p>	

E-Series NetApp Product	Quantum-Storage	Description
<p>E5424</p> <ul style="list-style-type: none"> <li>• DE5600 24-drive 2U drive enclosure</li> <li>• Code Name: Camden</li> <li>• With E5400 RAID controllers (Pikes Peak)</li> </ul>	<p>Quantum StorNext QS2400</p>	
<p>E5412</p> <ul style="list-style-type: none"> <li>• DE1600 12-drive 2U drive enclosure</li> <li>• Code Name: Ebbets</li> <li>• With E5400 RAID controllers (Pikes Peak)</li> </ul>	<p>Quantum StorNext QS1200</p>	

## Product Safety Statements

Quantum will not be held liable for damage arising from unauthorized use of the product. The user assumes all risk in this aspect.

This unit is engineered and manufactured to meet all safety and regulatory requirements. Be aware that improper use may result in bodily injury, damage to the equipment, or interference with other equipment.

**WARNING:** Before operating this product, read all instructions and warnings in this document and in the system, safety, and regulatory guide.

---

**警告** 在使用本产品之前，请先阅读本文件及系统、安全和法规信息指南中所有的说明和警告信息。

---

**警告** 操作本产品前，请先阅读本文件及系统、安全与法规资讯指南中的指示与警告说明。

---

**ADVERSAL** Læs alle instruktioner og advarsler i dette dokument og i *Vejledning om system-sikkerheds- og lovgivningsoplysninger*, før produktet betjenes.

---

**AVERTISSEMENT** Avant d'utiliser ce produit, lisez la totalité des instructions et avertissements de ce document et du *Guide d'informations sur le système, la sécurité et la réglementation*.

---

**HINWEIS** Lesen Sie vor der Verwendung dieses Produkts alle Anweisungen und Warnhinweise in diesem Dokument und im System, Safety, and Regulatory Information Guide (Info-Handbuch: System, Sicherheit und Richtlinien).

---

**אזהרה** לפני ההפעלה של מוצר זה, קרא את כל ההוראות והאזהרות הכלולות במסמך זה וכן במדריך מידע בנושאי מערכת, בטיחות ותקינה

---

**警告** この製品を使用する前に、本文書、および『システム、安全、規制に関する情報ガイド』に記載しているすべての警告と指示をお読みください。

---

**경고** 이 제품을 작동하기 전에 이 문서 및 시스템, 안전, 및 규제 정보 안내서에 수록된 모든 지침과 경고 표지를 숙지하십시오.

---

---

**ПРЕДУПРЕЖДЕНИЕ**

Перед началом эксплуатации данного устройства ознакомьтесь во всеми инструкциями и предупреждениями, приведенными в данном документе и в *Справочном руководстве по устройству, технике безопасности и действующим нормативам*.

---

---

**ADVERTENCIA**

Antes de utilizar este producto, lea todas las instrucciones y advertencias en este documento y en la Guía informativa sobre sistema, seguridad y normas.

---

---

**WARNING**

Läs alla anvisningar och varningar i detta dokument och i *System, säkerhet och krav från myndigheter - Informationshandbok* innan denna produkt tas i bruk.

---

---

**Contacts**

---

For information about contacting Quantum, including Quantum office locations, go to:

<http://www.quantum.com/aboutus/contactus/index.aspx>

---

**Comments**

---

To provide comments or feedback about this document, or about other Quantum technical publications, send e-mail to:

[doc-comments@quantum.com](mailto:doc-comments@quantum.com)

---

**Quantum Global Services**

---

Accelerate service issue resolution with these exclusive Quantum StorageCare services:

- **Service and Support Website** - Register products, license software, browse Quantum Learning courses, check backup software and operating system support, and locate manuals, FAQs, firmware downloads, product updates and more in one convenient location. Benefit today at:

<http://www.quantum.com/serviceandsupport/get-help/index.aspx#contact-support>

- **eSupport** - Submit online service requests, update contact information, add attachments, and receive status updates via email. Online Service accounts are free from Quantum. That account can



also be used to access Quantum's Knowledge Base, a comprehensive repository of product support information. Get started at:

<http://www.quantum.com/customercenter/>

For further assistance, or if training is desired, contact the Quantum Customer Support Center:

<b>North America</b>	1-800-284-5101 (toll free) +1-720-249-5700
<b>EMEA</b>	+800-7826-8888 (toll free) +49-6131-324-185
<b>APAC</b>	+800-7826-8887 (toll free) +603-7953-3010

For worldwide support:

<http://www.quantum.com/serviceandsupport/get-help/index.aspx#contact-support>



**SANtricity® System Manager 11.41**

# **Installing and Configuring for Linux®**

Express Guide

December 2017 | 215-11893\_B0  
doccomments@netapp.com

 **NetApp®**



# Contents

<b>Deciding whether to use this Express Guide .....</b>	<b>4</b>
<b>Understanding the workflow .....</b>	<b>6</b>
<b>Verifying the configuration is supported .....</b>	<b>7</b>
<b>Configuring management port IP addresses using the Quick Connect utility .....</b>	<b>9</b>
<b>Configuring the multipath software .....</b>	<b>10</b>
<b>Installing and configuring Linux Unified Host Utilities 7.0 .....</b>	<b>11</b>
<b>Performing FC-specific tasks .....</b>	<b>12</b>
Configuring the switches—FC .....	12
Determining host WWPNs and making the recommended settings—FC .....	12
<b>Performing iSCSI-specific tasks .....</b>	<b>14</b>
Configuring the switches—iSCSI .....	14
Configuring networking—iSCSI .....	14
Configuring array-side networking—iSCSI .....	15
Configuring host-side networking—iSCSI .....	18
Verifying IP network connections—iSCSI .....	20
<b>Performing iSER over Infiniband-specific tasks .....</b>	<b>21</b>
Configuring subnet manager .....	21
Configuring network connections—iSER over Infiniband .....	21
Configuring networking for storage attached hosts—iSER over Infiniband .....	22
<b>Performing SRP over Infiniband-specific tasks .....</b>	<b>25</b>
Determining host port GUIDs and making the recommended settings—SRP over Infiniband .....	25
Configuring subnet manager .....	25
Configuring network connections—SRP over Infiniband .....	26
<b>Performing SAS-specific tasks .....</b>	<b>28</b>
<b>Accessing SANtricity System Manager and using Setup wizard .....</b>	<b>29</b>
<b>Discovering storage on the host .....</b>	<b>31</b>
<b>Configuring storage on the host .....</b>	<b>32</b>
<b>Verifying storage access on the host .....</b>	<b>34</b>
<b>FC worksheet .....</b>	<b>35</b>
<b>iSCSI worksheet .....</b>	<b>37</b>
<b>iSER over Infiniband worksheet .....</b>	<b>38</b>
<b>SRP over Infiniband worksheet .....</b>	<b>41</b>
<b>SAS worksheet .....</b>	<b>42</b>
<b>Where to find additional information .....</b>	<b>43</b>
<b>Copyright information .....</b>	<b>44</b>
<b>Trademark information .....</b>	<b>45</b>
<b>How to send comments about documentation and receive update notifications .....</b>	<b>46</b>

## Deciding whether to use this Express Guide

---

The express method for installing your storage array and accessing SANtricity System Manager is appropriate for setting up a standalone Linux host to an E-Series storage system. It is designed to get the storage system up and running as quickly as possible with minimal decision points.

**Note:** The configuration that the express method provides might not meet the needs of your production environment. For additional options for installing and configuring the storage system, see the *SANtricity Power Guide* for your operating system.

The express method includes the following steps:

1. Setting up one of the following communication environments:
  - Fibre Channel (FC)
  - iSCSI
  - SAS
2. Creating logical volumes on the storage array and assigning a logical unit number (LUN) to each volume.
3. Making the volume LUNs available to the data host.

This guide is based on the following assumptions:

Component	Assumptions
Hardware	<ul style="list-style-type: none"> <li>• You have used the Installation and Setup Instructions included with the controller shelves to install the hardware.</li> <li>• You have connected cables between the optional drive shelves and the array controllers.</li> <li>• You have applied power to the storage array.</li> <li>• You have installed all other hardware (for example, management station, switches) and made the necessary connections.</li> </ul>
Host	<ul style="list-style-type: none"> <li>• You have made a connection between the storage array and the data host.</li> <li>• You have installed the host operating system.</li> <li>• You are not using Linux as a virtualized guest.</li> <li>• You are not configuring the data (I/O attached) host to boot from SAN.</li> </ul>
Storage management station	<ul style="list-style-type: none"> <li>• You are using a 1 Gbps or faster management network.</li> <li>• You are using a separate station for management rather than the data (I/O attached) host.</li> <li>• You are using out-of-band management, in which a storage management station sends commands to the storage array through the Ethernet connections to the controller.</li> <li>• You have attached the management station to the same subnet as the storage management ports.</li> </ul>

Component	Assumptions
IP addressing	<ul style="list-style-type: none"> <li>You have <b>not</b> yet made an Ethernet connection between the management station and the storage array.</li> </ul>
Storage provisioning	<ul style="list-style-type: none"> <li>You will not use shared volumes.</li> <li>You will create pools rather than volume groups.</li> </ul>
Protocol: FC	<ul style="list-style-type: none"> <li>You have made all host-side FC connections and activated switch zoning.</li> <li>You are using NetApp-supported FC HBAs and switches.</li> <li>You are using FC HBA driver versions as listed on the <a href="#">NetApp Interoperability Matrix Tool</a>.</li> </ul>
Protocol: iSCSI	<ul style="list-style-type: none"> <li>You are using Ethernet switches capable of transporting iSCSI traffic.</li> <li>You have configured the Ethernet switches according to the vendor's recommendation for iSCSI.</li> </ul>
Protocol: SAS	<ul style="list-style-type: none"> <li>You are using NetApp-supported SAS HBAs.</li> <li>You are using SAS HBA driver versions as listed on the NetApp Interoperability Matrix Tool.</li> </ul>

**Note:** The instructions in this guide include examples for SUSE Linux and for Red Hat Enterprise Linux (RHEL). Examples for RHEL are specific to RHEL7.

If these assumptions are not correct for your installation, or if you want more conceptual background information, see the SANtricity Power Guide for your operating system.

#### Related information

[NetApp Interoperability Matrix Tool](#)

[SANtricity 11.40 Installing and Configuring for Linux Power Guide for Advanced Users](#)

## Understanding the workflow

---

This workflow guides you through the express method for configuring your storage array and SANtricity System Manager to make storage available to a host.

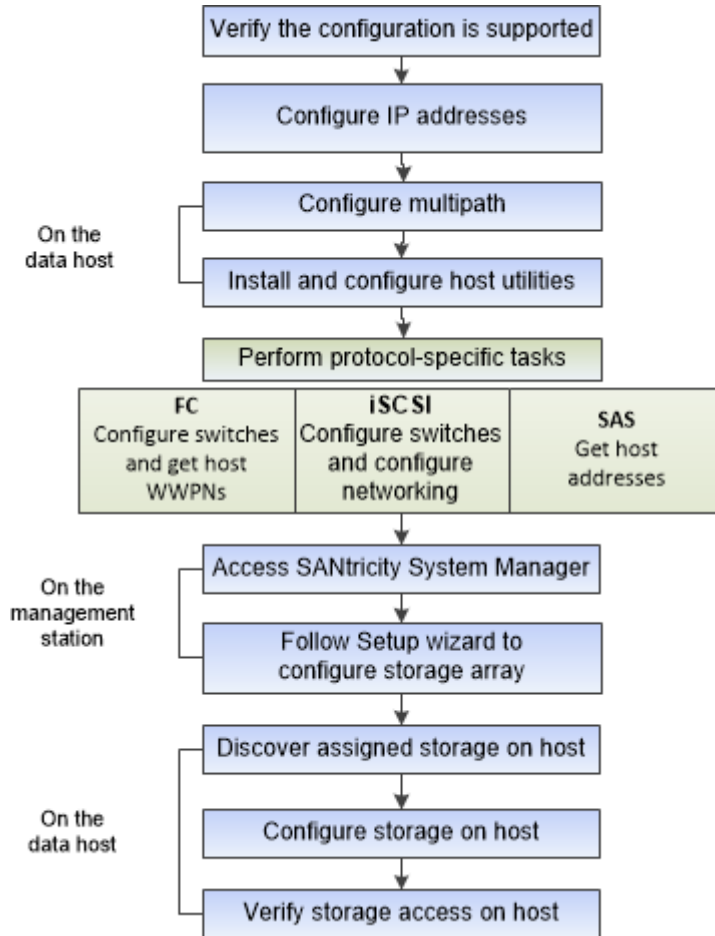

## Verifying the configuration is supported

To ensure reliable operation, you create an implementation plan and then use the NetApp Interoperability Matrix Tool (IMT) to verify that the entire configuration is supported.

### Steps

1. Go to the [NetApp Interoperability Matrix Tool](#).
2. Go to **Help > Online Help | Training** or **Help > What's New | FAQ** for training or refresher tools.

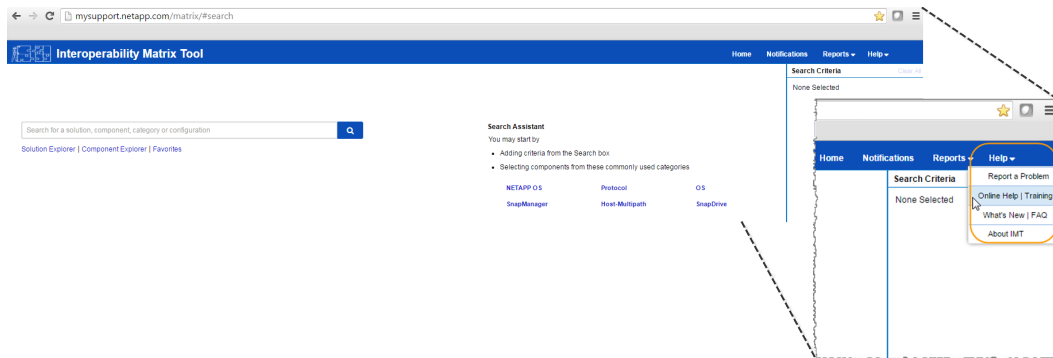

3. Use the search functions to enter the details of your configuration.

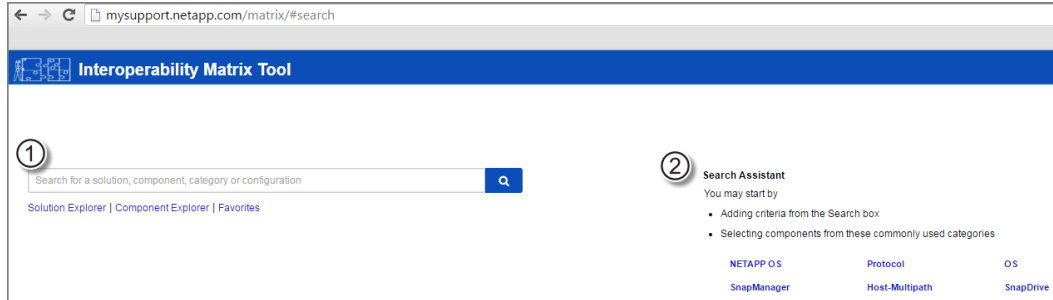

- |   |   |
|---|---|
| 1 | <b>Search box:</b> Enter a solution, component, category, or configuration for building initial criteria and inferring solutions. |
| 2 | <b>Search Assistant:</b> Use appropriate hints to infer solutions faster.   |

4. Click **View What Works With What** to select from a detailed matrix of components.

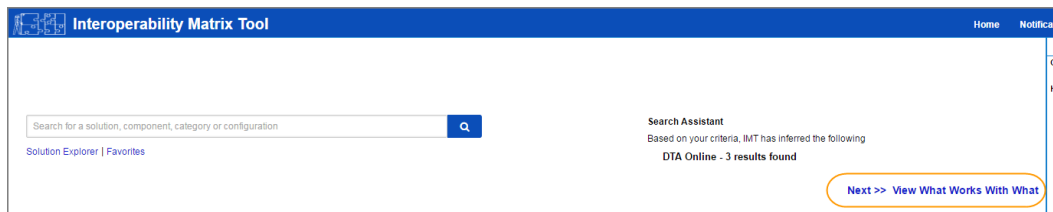



**Example**

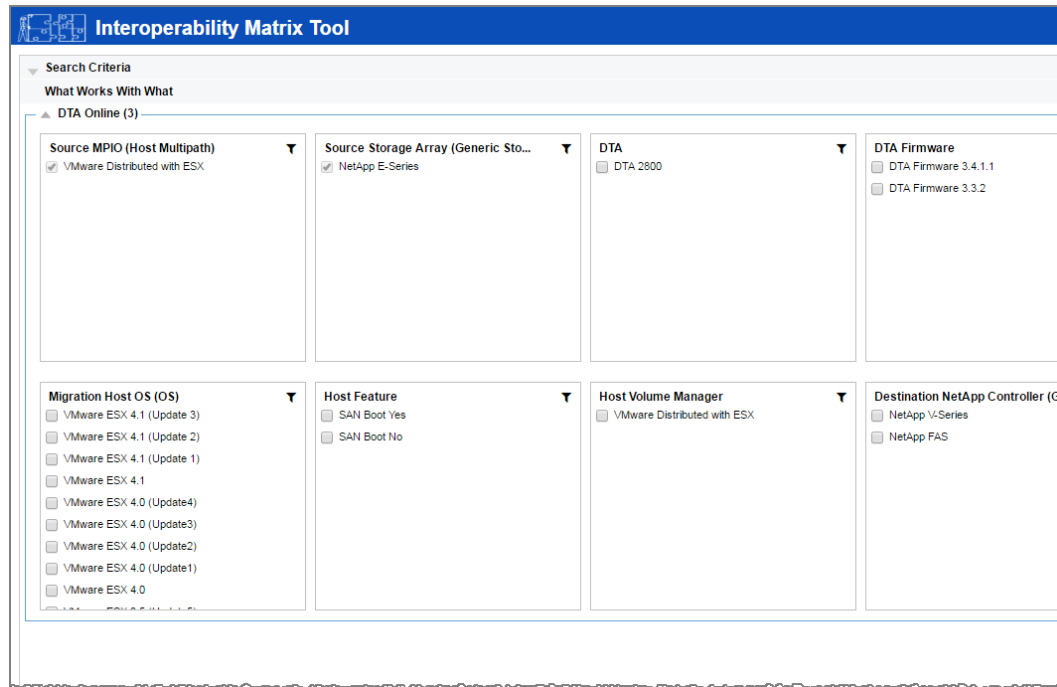

5. Review the information in the following tabs in the **Configuration Details** window:
  - **Notes:** Lists important information specific to your configuration. Review the alerts to identify the hot fixes that are required for your operating system.
  - **Policies & Guidelines:** Provides general guidelines for all SAN configurations.
6. As necessary, make the updates for your operating system and protocol as listed in the table.

Operating system updates	Protocol	Protocol-related updates
<i>not applicable</i>	FC	HBA driver, firmware, and bootcode
	iSCSI	Network interface card (NIC) driver, firmware and bootcode
	SAS	Host bus adapter (HBA) driver, firmware, and bootcode

**Related information**

[NetApp Interoperability Matrix Tool](#)

## Configuring management port IP addresses using the Quick Connect utility

---

In this best-practices method for configuring communications, you configure the management station and array controllers to communicate using the Quick Connect utility.

### Before you begin

- You have obtained the network configuration information from your network administrator for the controllers (IP address, subnet mask, and gateway or IP address and routable IP address).

### About this task

The following figure shows the location of management port 1 on the controllers. Note that an EF570 controller back view is shown but the E5700 controller is identical.

### Steps

1. Go to [SANtricity Quick Connect](#). Download and install the utility.
2. Follow the directions on the wizard screens to configure your management port and to configure the IP address of each controller.
3. Connect an Ethernet cable to management port 1 (labeled P1) on each controller, and connect the other end to your network.

**Note:** Do not use port 2 on either controller. These ports are reserved for use by NetApp technical personnel.

## Configuring the multipath software

---

Multipath software provides a redundant path to the storage array in case one of the physical paths is disrupted. The multipath software presents the operating system with a single virtual device that represents the active physical paths to the storage. The multipath software also manages the failover process that updates the virtual device. You use the device mapper multipath (DM-MP) tool for Linux installations.

### Steps

1. If a `multipath.conf` file is not already created, run the `# touch /etc/multipath.conf` command.
2. Use the default multipath settings by leaving the `multipath.conf` file blank.
3. Start the multipath service.

### Example

```
# systemctl start multipathd
```

4. Configure multipath for startup persistence.

### Example

```
# chkconfig multipathd on
```

5. Save your kernel version by running the `uname -r` command.

### Example

```
# uname -r  
3.10.0-327.el7.x86_64
```

You will use this information when you assign volumes to the host.

For additional configuration details, see [SANtricity 11.40 Installing and Configuring for Linux Power Guide for Advanced Users](#).

# Installing and configuring Linux Unified Host Utilities 7.0

---

Linux Unified Host Utilities 7.0 includes tools to manage NetApp storage, including failover policies and physical paths.

## Steps

1. Use the [NetApp Interoperability Matrix Tool](#) to determine the appropriate version of Unified Host Utilities 7.0 to install.

The versions are listed in a column within each supported configuration.

2. Download the Unified Host Utilities 7.0 from [NetApp Support](#).

## Related information

[Linux Unified Host Utilities 7.1 Installation Guide](#)

## Performing FC-specific tasks

---

For the Fibre Channel protocol, you configure the switches and determine the host port identifiers.

### Configuring the switches—FC

Configuring (zoning) the Fibre Channel (FC) switches enables the hosts to connect to the storage array and limits the number of paths. You zone the switches using the management interface for the switches.

#### Before you begin

- You must have administrator credentials for the switches.
- You must have used your HBA utility to discover the WWPN of each host initiator port and of each controller target port connected to the switch.

**Note:** It is helpful to record the WWPNs on the [FC worksheet](#) on page 35.

#### About this task

For details about zoning your switches, see the switch vendor's documentation.

You must zone by WWPN, not by physical port. Each initiator port must be in a separate zone with all of its corresponding target ports.

#### Steps

1. Log in to the FC switch administration program, and then select the zoning configuration option.
2. Create a new zone that includes the first host initiator port and that also includes all of the target ports that connect to the same FC switch as the initiator.
3. Create additional zones for each FC host initiator port in the switch.
4. Save the zones, and then activate the new zoning configuration.

### Determining host WWPNs and making the recommended settings—FC

You install an FC HBA utility so you can view the worldwide port name (WWPN) of each host port. Additionally, you can use the HBA utility to change any settings recommended in the Notes column of the [NetApp Interoperability Matrix Tool](#) for the supported configuration.

#### About this task

Guidelines for HBA utilities:

- Most HBA vendors offer an HBA utility. You will need the correct version of HBA for your host operating system and CPU. Examples of FC HBA utilities include:
  - Emulex OneCommand Manager for Emulex HBAs
  - QLogic QConverge Console for QLogic HBAs
- Record the WWPNs on the [FC worksheet](#) on page 35.

- Host I/O ports might automatically register if the host context agent is installed.

**Steps**

1. Download the appropriate utility from your HBA vendor's web site.
2. Install the utility.
3. Record the host identifiers on the *FC worksheet* on page 35.
4. Select the appropriate settings in the HBA utility.

Appropriate settings for your configuration are listed in the Notes column of the IMT.

**Related concepts**

*FC worksheet* on page 35

**Related information**

*NetApp Interoperability Matrix Tool*

## Performing iSCSI-specific tasks

---

For the iSCSI protocol, you configure the switches and configure networking on the array side and the host side. Then you verify the IP network connections.

### Configuring the switches—iSCSI

You configure the switches according to the vendor's recommendations for iSCSI. These recommendations might include both configuration directives as well as code updates.

You must ensure the following:

- You have two separate networks for high availability. Make sure that you isolate your iSCSI traffic to separate network segments.
- You have enabled send and receive hardware flow control **end to end**.
- You have disabled priority flow control.
- If appropriate, you have enabled jumbo frames.

**Note:** Port channels/LACP is not supported on the controller's switch ports. Host-side LACP is not recommended; multipathing provides the same, and in some cases better, benefits.

#### Related concepts

[iSCSI worksheet](#) on page 37

### Configuring networking—iSCSI

You can set up your iSCSI network in many ways, depending on your data storage requirements.

Consult your network administrator for tips on selecting the best configuration for your environment.

To configure an iSCSI network with basic redundancy, connect each host port and one port from each controller to separate switches, and partition each set of host ports and controller ports on separate network segments or VLANs.

You must enable send and receive hardware flow control **end to end**. You must disable priority flow control.

If you are using jumbo frames within the IP SAN for performance reasons, make sure to configure the array, switches, and hosts to use jumbo frames. Consult your operating system and switch documentation for information on how to enable jumbo frames on the hosts and on the switches. To enable jumbo frames on the array, complete the steps in *Configuring array-side networking—iSCSI*.

**Note:** Many network switches have to be configured above 9,000 bytes for IP overhead. Consult your switch documentation for more information.

#### Related tasks

[Configuring array-side networking—iSCSI](#) on page 15

## Configuring array-side networking—iSCSI

You use the SANtricity System Manager GUI to configure iSCSI networking on the array side.

### Before you begin

- You must know the IP address or domain name for one of the storage array controllers.
- You or your system administrator must have set up a password for the System Manager GUI, or you must configured Role-Based Access Control (RBAC) or LDAP and a directory service for the appropriate security access to the storage array. See the 11.40 version of *SANtricity System Manager online help* for more information about Access Management.

### About this task

This task describes how to access the iSCSI port configuration from the Hardware page. You can also access the configuration from **System > Settings > Configure iSCSI ports**.

### Steps

1. From your browser, enter the following URL:

**https://<DomainNameOrIPAddress>**

`IPAddress` is the address for one of the storage array controllers.

The first time SANtricity System Manager is opened on an array that has not been configured, the `Set Administrator Password` prompt appears. Role-based access management configures four local roles: `admin`, `support`, `security`, and `monitor`. The latter three roles have random passwords that cannot be guessed. After you set a password for the `admin` role you can change all of the passwords using the `admin` credentials. See *SANtricity System Manager online help* for more information on the four local user roles.

2. Enter the System Manager password for the `admin` role in the `Set Administrator Password` and `Confirm Password` fields, then select the **Set Password** button. Log out, then log back in to System Manager with the `admin` credentials.

When you open System Manager and no pools, volumes groups, workloads, or notifications have been configured, the Setup wizard launches.

3. Close the Setup wizard.

You will use the wizard later to complete additional setup tasks.

4. Select **Hardware**.

5. If the graphic shows the drives, click **Show back of shelf**.

The graphic changes to show the controllers instead of the drives.

6. Click the controller with the iSCSI ports you want to configure.

The controller's context menu appears.

7. Select **Configure iSCSI ports**.



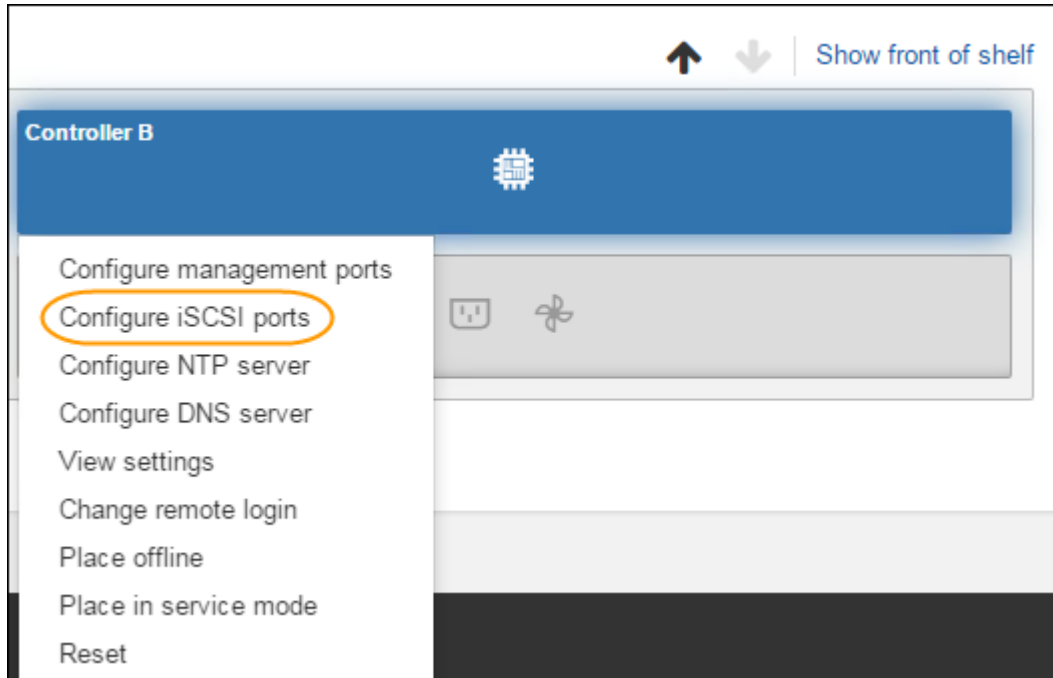

The Configure iSCSI Ports dialog box opens.

8. In the drop-down list, select the port you want to configure, and then click **Next**.
9. Select the configuration port settings, and then click **Next**.

To see all port settings, click the **Show more port settings** link on the right of the dialog box.

Port Setting	Description
Configured ethernet port speed	<p>Select the desired speed.</p> <p>The options that appear in the drop-down list depend on the maximum speed that your network can support (for example, 10 Gbps).</p> <p><b>Note:</b> The optional iSCSI host interface cards in the E5700 and EF570 controllers do not auto-negotiate speeds. You must set the speed for each port to either 10 Gb or 25 Gb. All ports must be set to the same speed.</p>
Enable IPv4 / Enable IPv6	Select one or both options to enable support for IPv4 and IPv6 networks.
TCP listening port (Available by clicking <b>Show more port settings</b> .)	<p>If necessary, enter a new port number.</p> <p>The listening port is the TCP port number that the controller uses to listen for iSCSI logins from host iSCSI initiators. The default listening port is 3260. You must enter 3260 or a value between 49152 and 65535.</p>
MTU size (Available by clicking <b>Show more port settings</b> .)	<p>If necessary, enter a new size in bytes for the Maximum Transmission Unit (MTU).</p> <p>The default Maximum Transmission Unit (MTU) size is 1500 bytes per frame. You must enter a value between 1500 and 9000.</p>

Port Setting	Description
Enable ICMP PING responses	Select this option to enable the Internet Control Message Protocol (ICMP). The operating systems of networked computers use this protocol to send messages. These ICMP messages determine whether a host is reachable and how long it takes to get packets to and from that host.

If you selected **Enable IPv4**, a dialog box opens for selecting IPv4 settings after you click **Next**. If you selected **Enable IPv6**, a dialog box opens for selecting IPv6 settings after you click **Next**. If you selected both options, the dialog box for IPv4 settings opens first, and then after you click **Next**, the dialog box for IPv6 settings opens.

10. Configure the IPv4 and/or IPv6 settings, either automatically or manually. To see all port settings, click the **Show more settings** link on the right of the dialog box.

Port setting	Description
Automatically obtain configuration	Select this option to obtain the configuration automatically.
Manually specify static configuration	Select this option, and then enter a static address in the fields. For IPv4, include the network subnet mask and gateway. For IPv6, include the routable IP address and router IP address.
Enable VLAN support (Available by clicking <b>Show more settings</b> .)	Select this option to enable a VLAN and enter its ID. A VLAN is a logical network that behaves like it is physically separate from other physical and virtual local area networks (LANs) supported by the same switches, the same routers, or both.
Enable ethernet priority (Available by clicking <b>Show more settings</b> .)	Select this option to enable the parameter that determines the priority of accessing the network. Use the slider to select a priority between 1 and 7.  In a shared local area network (LAN) environment, such as Ethernet, many stations might contend for access to the network. Access is on a first-come, first-served basis. Two stations might try to access the network at the same time, which causes both stations to back off and wait before trying again. This process is minimized for switched Ethernet, where only one station is connected to a switch port.

11. Click **Finish**.
12. Close System Manager.

You will use System Manager to configure you storage in [Accessing SANtricity System Manager and using Setup wizard](#) on page 29. For the Setup wizard to appear again, you must close and re-open System Manager or refresh your browser.

## Configuring host-side networking—iSCSI

You configure iSCSI networking on the host side by setting the number of node sessions per physical path, turning on the appropriate iSCSI services, configuring the network for the iSCSI ports, creating iSCSI face bindings, and establishing the iSCSI sessions between initiators and targets.

### About this task

In most cases, you can use the inbox software-initiator for iSCSI CNA/NIC. You do not need to download the latest driver, firmware, and BIOS. Refer to the [NetApp Interoperability Matrix Tool](#) to determine code requirements.

### Steps

1. Check the `node.session.nr_sessions` variable in the `/etc/iscsi/iscsid.conf` file to see the default number of sessions per physical path. If necessary, change the default number of sessions to one session.

#### Example

```
node.session.nr_sessions = 1
```

2. Change the `node.session.timeo.replacement_timeout` variable in the `/etc/iscsi/iscsid.conf` file to 20, from a default value of 120.

#### Example

```
node.session.timeo.replacement_timeout=20
```

3. Make sure `iscsid` and `(open-)iscsi` services are on and enabled for boot.

#### Red Hat Enterprise Linux 7 (RHEL 7)

#### Example

```
# systemctl start iscsi
# systemctl start iscsid
# systemctl enable iscsi
# systemctl enable iscsid
```

#### SUSE Linux Enterprise Server 12 (SLES 12)

#### Example

```
# systemctl start iscsid.service
# systemctl enable iscsid.service
```

4. Get the host IQN initiator name, which will be used to configure the host to an array.

#### Example

```
# cat /etc/iscsi/initiatorname.iscsi
```

5. Configure the network for iSCSI ports:

**Note:** In addition to the public network port, iSCSI initiators should use two NICs or more on separate private segments or vLANs.

- a. Determine the iSCSI port names using the `# ifconfig -a` command.
- b. Set the IP address for the iSCSI initiator ports. The initiator ports should be present on the same subnet as the iSCSI target ports.

#### Example

```
# vim /etc/sysconfig/network-scripts/ifcfg-<NIC port>Edit:
BOOTPROTO=none
ONBOOT=yes
NM_CONTROLLED=no
Add: IPADDR=192.168.xxx.xxx
NETMASK=255.255.255.0
```

**Note:** Be sure to set the address for both iSCSI initiator ports.

- c. Restart network services.

#### Example

```
# systemctl restart network
```

- d. Make sure the Linux server can ping *all* of the iSCSI target ports.
6. Configure the iSCSI interfaces by creating two iSCSI iface bindings.

#### Example

```
iscsiadm -m iface -I iface0 -o new
iscsiadm -m iface -I iface0 -o update -n iface.net_ifacename -v <NIC
port1>
```

```
iscsiadm -m iface -I iface1 -o new
iscsiadm -m iface -I iface1 -o update -n iface.net_ifacename -v <NIC
port2>
```

**Note:** To list the interfaces, use `iscsiadm -m iface`.

7. Establish the iSCSI sessions between initiators and targets (four total).
  - a. Discover iSCSI targets. Save the IQN (it will be the same with each discovery) in the worksheet for the next step.

#### Example

```
iscsiadm -m discovery -t sendtargets -p 192.168.0.1:3260 -I iface0
-P 1
```

**Note:** The IQN looks like the following:

```
iqn.1992-01.com.netapp:2365.60080e50001bf160000000531d7be3
```

- b. Create the connection between the iSCSI initiators and iSCSI targets, using ifaces.

**Example**

```
iscsiadm -m node -T iqn.1992-01.com.netapp:
2365.60080e50001bf1600000000531d7be3
-p 192.168.0.1:3260 -I iface0 -l
```

- c. List the iSCSI sessions established on the host.

**Example**

```
# iscsiadm -m session
```

## Verifying IP network connections—iSCSI

You verify Internet Protocol (IP) network connections by using ping tests to ensure the host and array are able to communicate.

**Steps**

1. On the host, run one of the following commands, depending on whether jumbo frames are enabled:
  - If jumbo frames are not enabled, run this command:

```
ping -I <hostIP> <targetIP>
```

- If jumbo frames are enabled, run the ping command with a payload size of 8,972 bytes. The IP and ICMP combined headers are 28 bytes, which when added to the payload, equals 9,000 bytes. The `-s` switch sets the `packet size` bit. The `-d` switch sets the debug option. These options allow jumbo frames of 9,000 bytes to be successfully transmitted between the iSCSI initiator and the target.

```
ping -I <hostIP> -s 8972 -d <targetIP>
```

In this example, the iSCSI target IP address is 192.0.2.8.

```
#ping -I 192.0.2.100 -s 8972 -d 192.0.2.8
Pinging 192.0.2.8 with 8972 bytes of data:
Reply from 192.0.2.8: bytes=8972 time=2ms TTL=64
Reply from 192.0.2.8: bytes=8972 time=2ms TTL=64
Reply from 192.0.2.8: bytes=8972 time=2ms TTL=64
Reply from 192.0.2.8: bytes=8972 time=2ms TTL=64
Ping statistics for 192.0.2.8:
    Packets: Sent = 4, Received = 4, Lost = 0 (0% loss),
    Approximate round trip times in milli-seconds:
        Minimum = 2ms, Maximum = 2ms, Average = 2ms
```

2. Issue a ping command from each host's initiator address (the IP address of the host Ethernet port used for iSCSI) to each controller iSCSI port. Perform this action from each host server in the configuration, changing the IP addresses as necessary.

**Note:** If the command fails (for example, returns `Packet needs to be fragmented but DF set`), verify the MTU size (jumbo frame support) for the Ethernet interfaces on the host server, storage controller, and switch ports.

## Performing iSER over Infiniband-specific tasks

For the InfiniBand iSER over Infiniband protocol, you configure subnet manager and configure the storage array and the hosts with iSER networking.

### Configuring subnet manager

NetApp recommends against using an Infiniband switch to run subnet manager as this may cause unexpected path loss during high loads. Instead NetApp recommends configuring the subnet manager on one or more of your hosts using opensm.

#### Steps

1. Install `opensm` packages on any hosts that will be running the subnet manager.
2. Enable the `opensm` service.

#### For RHEL 7.x and SLES 12.x

- To enable the `opensm` service on boot:

```
systemctl enable opensm
```

- To start the `opensm` service immediately:

```
systemctl start opensm
```

#### For RHEL 6.x and SLES 11.x

- To enable the `opensm` service on boot:

```
chkconfig opensm on
```

- To start the `opensm` service immediately:

```
service opensm start
```

3. Start two instances of the subnet manager, one for each subnet, by adding the following commands to `/etc/init.d/after.local` for SUSE or `etc/rc.d/rc.local` for RedHat:

```
opensm -B -g GUID0 -p 15 -f /var/log/opensm-ib0.log
```

```
opensm -B -g GUID1 -p 14 -f /var/log/opensm-ib1.log
```

### Configuring network connections—iSER over Infiniband

If your configuration uses the iSER over Infiniband protocol, perform the steps in this section.

#### About this task

When you are using a 56-Gbps HIC with the iSER over Infiniband protocol, additional array configuration is required.

**Steps**

1. From the **Setup** tab, select **Configure iSCSI Host Ports** to set the storage array iSCSI addresses. Put the array iSCSI addresses on the same subnet as the host port(s) you will use to create iSCSI sessions. For addresses, see [iSER worksheet](#) on page 38.
2. From the **Devices** tab, select the storage array and go to **iSER > Manage Settings** to find the IQN. This information might be necessary when you create iSER sessions from operating systems that do not support send targets discovery. Enter this information in the worksheet, in [iSER worksheet](#) on page 38.

## Configuring networking for storage attached hosts—iSER over Infiniband

The InfiniBand OFED driver stack supports running both iSER and SRP simultaneously on the same ports, so no additional hardware is required.

**Before you begin**

A NetApp recommended OFED is installed on the system. For more information, see the [NetApp Interoperability Matrix Tool](#).

**Steps**

1. Enable and start iSCSI services on the host(s):

**Red Hat Enterprise Linux 7 (RHEL 7)**

```
# systemctl start iscsi
# systemctl start iscsid
# systemctl enable iscsi
# systemctl enable iscsid
```

**SUSE Linux Enterprise Server 12 (SLES 12)**

```
# systemctl start iscsid.service
# systemctl enable iscsid.service
```

2. Configure IPoIB network interfaces:
  - a. Identify the InfiniBand ports that will be used. Document the HW Address (MAC address) of each port.
  - b. Configure persistent names for the InfiniBand network interface devices.
  - c. Configure the IP address and network information for the IPoIB interfaces identified.

The specific interface configuration required might vary depending on the operating system used. Consult your vendor's operating system documentation for specific information on implementation.

**Example**

For RHEL 6.x Interface Name `ib0`, edit the `/etc/sysconfig/network-scripts/ifcfg-ib0` configuration file.

```
ONBOOT=yes
Name=ib0
Type=InfiniBand
IPADDR=192.168.xx.yy
PREFIX=24
DEFROUTE=no
HWADDR=<Port 0 HW Address Here>
```

- d. Start the IB network interfaces by restarting the networking service or by manually restarting each interface. For example:

**Example**

```
#service network restart
```

- e. Verify connectivity to the target ports. From the host, ping the IP addresses you configured when you configured network connections.
3. Restart services to load the iSER module.
  4. Edit the iSCSI settings in `/etc/iscsi/iscsid.conf`.

```
node.startup = automatic replacement_timeout = 20
```

5. Create iSCSI session configurations:
  - a. Create iface configuration files for each InfiniBand interface.

**Example**

**Note:** The directory location for the iSCSI iface files is operating system dependent. This example is for using Red Hat Enterprise Linux:

```
iscsiadm -m iface -I iser > /var/lib/iscsi/ifaces/iface-ib0
iscsiadm -m iface -I iser > /var/lib/iscsi/ifaces/iface-ib1
```

- b. Edit each iface file to set the interface name and initiator IQN. Set the following parameters appropriately for each iface file:

Option	Value
<code>iface.net_ifacename</code>	The interface device name (ex. <code>ib0</code> ).
<code>iface.initiatorname</code>	The host initiator IQN documented in the worksheet.

- c. Create iSCSI sessions to the target.

The preferred method to create the sessions is to use the `SendTargets` discovery method. However, this method does not work on some operating system releases.

**Note:** Use **Method 2** for RHEL 6.x or SLES 11.3 or later.



- **Method 1 – SendTargets discovery:** Use the SendTargets discovery mechanism to one of the target portal IP addresses. This will create sessions for each of the target portals.

```
iscsiadm -m discovery -t st -p 192.168.130.101 -I iser
```

- **Method 2 – Manual creation:** For each target portal IP address, create a session using the appropriate host interface iface configuration. In this example, interface ib0 is on subnet A and interface ib1 is on subnet B. For these variables, substitute the appropriate value from the worksheet:
  - <Target IQN> = storage array Target IQN
  - <Target Port IP> = IP address configured on the specified target port

```
# Controller A Port 1
iscsiadm -m node -target <Target IQN> -I iface-ib0 -p <Target Port IP> -l -o new
# Controller B Port 1
iscsiadm -m node -target <Target IQN> -I iface-ib0 -p <Target Port IP> -l -o new
# Controller A Port 2
iscsiadm -m node -target <Target IQN> -I iface-ib1 -p <Target Port IP> -l -o new
# Controller B Port 2
iscsiadm -m node -target <Target IQN> -I iface-ib1 -p <Target Port IP> -l -o new
```

## 6. Log in to iSCSI sessions.

For each session, run the `iscsiadm` command to log in to the session.

```
# Controller A Port 1
iscsiadm -m node -target <Target IQN> -I iface -ib0 -p <Target Port IP> -l
# Controller B Port 1
iscsiadm -m node -target <Target IQN> -I iface -ib0 -p <Target Port IP> -l
# Controller A Port 2
iscsiadm -m node -target <Target IQN> -I iface -ib1 -p <Target Port IP> -l
# Controller B Port 2
iscsiadm -m node -target <Target IQN> -I iface -ib1 -p <Target Port IP> -l
```

## 7. Verify the iSER/iSCSI sessions.

- Check the iscsi session status from the host:

```
iscsiadm -m session
```

- Check the iscsi session status from the array. From SANtricity System Manager, navigate to the **Storage Array > iSER > View/End Sessions**.

### Result

When the OFED/RDMA service starts, the iSER kernel module(s) loads by default when the iSCSI services are running. To complete the iSER connection setup, the iSER module(s) should be loaded. Currently this requires a host reboot.

### Related information

[NetApp Interoperability Matrix Tool](#)

## Performing SRP over Infiniband-specific tasks

---

For the InfiniBand SRP over Infiniband protocol, you configure the subnet manager, configure networking, determine host port addresses, and make the settings recommended in the Notes column of the [NetApp Interoperability Matrix Tool](#).

### Determining host port GUIDs and making the recommended settings—SRP over Infiniband

The `InfiniBand-diags` package includes commands to display the globally unique ID (GUID) of each InfiniBand (IB) port. Most Linux distributions with OFED/RDMA supported through the included packages also have the `InfiniBand-diags` package, which includes commands to display information about the HCA.

#### Steps

1. Install the `InfiniBand-diags` package using the operating system's package management commands.
2. Run the `ibstat` command to display the port information.
3. Record the initiator's GUIDs on the [SRP worksheet](#) on page 41.
4. Select the appropriate settings in the HBA utility.

Appropriate settings for your configuration are listed in the Notes column of the [NetApp Interoperability Matrix Tool](#).

#### Related information

[NetApp Interoperability Matrix Tool](#)

### Configuring subnet manager

NetApp recommends against using an Infiniband switch to run subnet manager as this may cause unexpected path loss during high loads. Instead NetApp recommends configuring the subnet manager on one or more of your hosts using `opensm`.

#### Steps

1. Install `opensm` packages on any hosts that will be running the subnet manager.
2. Enable the `opensm` service.

#### For RHEL 7.x and SLES 12.x

- To enable the `opensm` service on boot:

```
systemctl enable opensm
```

- To start the `opensm` service immediately:

```
systemctl start opensm
```

**For RHEL 6.x and SLES 11.x**

- To enable the opensm service on boot:

```
chkconfig opensm on
```

- To start the opensm service immediately:

```
service opensm start
```

3. Start two instances of the subnet manager, one for each subnet, by adding the following commands to `/etc/init.d/after.local` for SUSE or `etc/rc.d/rc.local` for RedHat:

```
opensm -B -g GUID0 -p 15 -f /var/log/opensm-ib0.log
```

```
opensm -B -g GUID1 -p 14 -f /var/log/opensm-ib1.log
```

## Configuring network connections—SRP over Infiniband

If your configuration uses the SRP over Infiniband protocol, follow the steps in this section.

**About this task**

To connect the Linux host to the storage array, you must enable the InfiniBand driver stack with the appropriate options. Specific settings might vary between Linux distributions. Check the [NetApp Interoperability Matrix Tool](#) for specific instructions and additional recommended settings specific to your solution.

**Steps**

1. Install the OFED/RDMA driver stack for your OS.
2. Configure OFED/RDMA to load the SRP module.
3. In the OFED/RDMA configuration file, set `SRP_LOAD=yes` and `SRP_DAEMON_ENABLE=yes`.
4. Enable and start the OFED/RDMA service.

**For RHEL 7.x and SLES 12.x**

- To enable the InfiniBand modules to load on boot:

```
systemctl enable rdma
```

- To load the InfiniBand modules immediately:

```
systemctl start rdma
```

**For RHEL 6.x and SLES 11.x**

- To enable the InfiniBand modules to load on boot:

```
chkconfig rdma on
```

- To load the InfiniBand modules immediately:

```
service rdma start
```

**5. Enable the SRP daemon.**

**For RHEL 7.x and SLES 12**

- To enable the SRP daemon to start on boot:

```
systemctl enable srpd
```

- To start the SRP daemon immediately:

```
systemctl start srpd
```

**For RHEL 6.x and SLES 11.x**

- To enable the SRP daemon to start on boot:

```
chkconfig srpd on
```

- To start the SRP daemon immediately:

```
service srpd start
```

**Related information**

[NetApp Interoperability Matrix Tool](#)

## Performing SAS-specific tasks

---

For the SAS protocol, you determine host port addresses and make the settings recommended in the Notes column of the *NetApp Interoperability Matrix Tool (IMT)*.

### About this task

Guidelines for HBA utilities:

- Most HBA vendors offer an HBA utility. Depending on your host operating system and CPU, use either the LSI-sas2flash(6G) or sas3flash(12G) utility.
- It is helpful to record the SAS addresses on the *SAS worksheet* on page 42.
- Host I/O ports might automatically register if the host context agent is installed.

### Steps

1. Download the LSI-sas2flash(6G) or sas3flash(12G) utility from your HBA vendor's web site.
2. Install the utility.
3. Record the host identifiers (SAS addresses) on the *SAS worksheet* on page 42.
4. Use the HBA BIOS to select the appropriate settings for your configuration.  
See the Notes column of the *NetApp Interoperability Matrix Tool* for recommendations.

### Related concepts

*SAS worksheet* on page 42

### Related information

*NetApp Interoperability Matrix Tool*

## Accessing SANtricity System Manager and using Setup wizard

---

You use the Setup wizard in SANtricity System Manager to configure your storage array.

### Before you begin

- You have ensured that the device from which you will access SANtricity System Manager contains one of the following browsers:

Browser	Minimum version
Google Chrome	47
Microsoft Internet Explorer	11
Microsoft Edge	EdgeHTML 12
Mozilla Firefox	31
Safari	9

- You are using out-of-band management.

### About this task

If you are an iSCSI user, make sure you have closed the Setup wizard while configuring iSCSI.

The wizard automatically relaunches when you open System Manager or refresh your browser and *at least one* of the following conditions is met:

- No pools and volume groups are detected.
- No workloads are detected.
- No notifications are configured.

If the Setup wizard does not automatically appear, contact technical support.

**Important:** System Manager allows you to manage just your E2800 or E5700 storage array. You need SANtricity Storage Manager to manage the storage enterprise and arrays other than the E2800 or E5700. See the SANtricity *Storage Manager Express Guide* for your operating system for installation instructions.

### Steps

- From your browser, enter the following URL:

**https://<DomainNameOrIPAddress>**

*IPAddress* is the address for one of the storage array controllers.

The first time SANtricity System Manager is opened on an array that has not been configured, the *Set Administrator Password* prompt appears. Role-based access management configures four local roles: *admin*, *support*, *security*, and *monitor*. The latter three roles have random passwords that cannot be guessed. After you set a password for the *admin* role you can change all of the passwords using the *admin* credentials. See *SANtricity System Manager online help* for more information on the four local user roles.

2. Enter the System Manager password for the `admin` role in the `Set Administrator Password` and `Confirm Password` fields, then select the **Set Password** button. Log out, then log back in to System Manager with the `admin` credentials.

When you open System Manager and no pools, volumes groups, workloads, or notifications have been configured, the Setup wizard launches.

3. Use the Setup wizard to perform the following tasks:
  - **Verify hardware (controllers and drives)** – Verify the number of controllers and drives in the storage array. Assign a name to the array.
  - **Verify hosts and operating systems** – Verify the host and operating system types that the storage array can access.
  - **Select applications** – Specify applications, such as Exchange or SQL. System Manager optimizes storage based on application type.
  - **Define workloads** – Set up workloads, which are storage objects that support applications. You define one or more workloads per application.
  - **Accept pools** – Accept the recommended pool configuration for the express installation method. A pool is a logical group of drives.
  - **Configure alerts** – Allow System Manager to receive automatic notifications when a problem occurs with the storage array.
  - **Enable AutoSupport** – Automatically monitor the health of your storage array and have dispatches sent to technical support.
4. Create volumes by going to **Storage > Volumes > Create > Volume**.

For more information, see the online help for SANtricity System Manager.

## Discovering storage on the host

---

LUNs on your storage system appear as disks to the Linux host. When you add new LUNs, you must manually rescan the associated disks to discover them. The host does not automatically discover new LUNs.

### Steps

1. Scan the LUNs by running the `# rescan-scsi-bus.sh` command from a terminal window on the host.

This command works only if `sg3_utils` is installed. Alternatively, you can reboot the host or manually scan each SCSI host.

```
# echo "-- --"
> /sys/class/scsi_host/host3/scan
```

2. Verify disk discovery by running the `# sanlun lun show -p` command.

### Example

```
# sanlun lun show
controller(7mode/E-Series)
<column headings deleted for readability>
-----
ictm1619s01c01-SRP  /dev/sddi  host14  SRP  E-Series
ictm1619s01c01-SRP  /dev/sddh  host14  SRP  E-Series
ictm1619s01c01-SRP  /dev/sddf  host14  SRP  E-Series
```



## Configuring storage on the host

---

A new LUN has no partition or file system when the Linux host first discovers it. You must format the LUN before it can be used. Optionally, you can create a file system on the LUN.

### Before you begin

The host must have discovered the LUN.

In the `/dev/mapper` folder, you have run the `ls` command to see the available disks.

### About this task

You can initialize the disk as a basic disk with a GUID partition table (GPT) or Master boot record (MBR).

Format the LUN with a file system such as ext4. Some applications do not require this step.

### Steps

1. Retrieve the SCSI ID of the mapped disk by issuing the `sanlun lun show -p` command.

The SCSI ID is a 33-character string of hexadecimal digits, beginning with the number 3. If user-friendly names are enabled, Device Mapper reports disks as `mpath` instead of by a SCSI ID.

### Example

```
# sanlun lun show -p
      E-Series Array: ictm1619s01c01-
SRP(60080e50002908b40000000054efb9d2)
      Volume Name:
      Preferred Owner: Controller in Slot B
      Current Owner: Controller in Slot B
      Mode: RDAC (Active/Active)
      UTM LUN: None
      LUN: 116
      LUN Size:
      Product: E-Series
      Host Device:
mpathr(360080e50004300ac000007575568851d)
      Multipath Policy: round-robin 0
      Multipath Provider: Native
-----
host      controller
path      path      /dev/    host      controller
state     type      node     adapter   target
-----
up        secondary sdcx     host14    A1
up        secondary sdat     host10    A2
up        secondary sdbv     host13    B1
```

2. Create a new partition according to the method appropriate for your Linux OS release.

Typically, characters identifying the partition of a disk are appended to the SCSI ID (the number 1 or p3 for instance).

**Example**

```
# parted -a optimal -s -- /dev/mapper/  
360080e5000321bb8000092b1535f887a mklabel  
gpt mkpart primary ext4 0% 100%
```

3. Create a file system on the partition.

The method for creating a file system varies depending on the file system chosen.

**Example**

```
# mkfs.ext4 /dev/mapper/360080e5000321bb8000092b1535f887a1
```

4. Create a folder to mount the new partition.

**Example**

```
# mkdir /mnt/ext4
```

5. Mount the partition.

**Example**

```
# mount /dev/mapper/360080e5000321bb8000092b1535f887a1 /mnt/ext4
```

## Verifying storage access on the host

---

Before using the LUN, you verify that the host can write data to the LUN and read it back.

### Before you begin

You must have initialized the LUN and formatted it with a file system.

### Steps

1. On the host, copy one or more files to the mount point of the disk.
2. Copy the files back to a different folder on the original disk.
3. Run the `diff` command to compare the copied files to the originals.
4. Run the `multipath -ll` command to view the paths to the LUN, and verify that you have four paths.
5. Force a controller failover, preferably by pulling all cables from one controller, and then verify that you can still access the files on the LUN. When you are finished, reset the storage to an optimal state.

### After you finish

Remove the file and folder that you copied.

## FC worksheet

You can use this worksheet to record FC storage configuration information. You need this information to perform provisioning tasks.

The illustration shows a host connected to an E-Series storage array in two zones. One zone is indicated by the blue line; the other zone is indicated by the red line. Any single port has two paths to the storage (one to each controller).

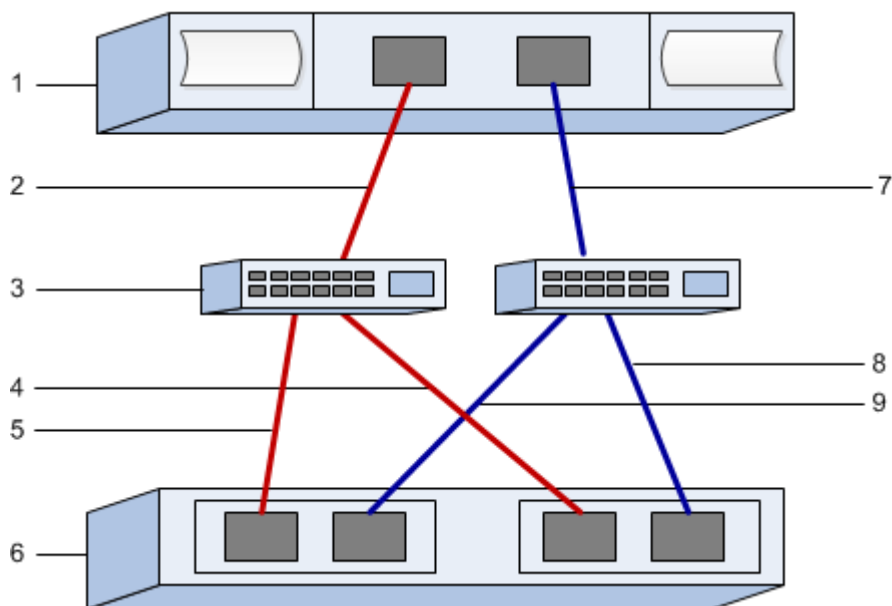

### Host identifiers

Callout No.	Host (initiator) port connections	WWPN
1	Host	<i>not applicable</i>
2	Host port 0 to FC switch zone 0	
7	Host port 1 to FC switch zone 1	

### Target identifiers

Callout No.	Array controller (target) port connections	WWPN
3	Switch	<i>not applicable</i>
6	Array controller (target)	<i>not applicable</i>
5	Controller A, port 1 to FC switch 1	
9	Controller A, port 2 to FC switch 2	
4	Controller B, port 1 to FC switch 1	
8	Controller B, port 2 to FC switch 2	

**Mapping host**

Mapping host name	
Host OS type	

## iSCSI worksheet

You can use this worksheet to record iSCSI storage configuration information. You need this information to perform provisioning tasks.

### Recommended configuration

Recommended configurations consist of two initiator ports and four target ports with one or more VLANs.

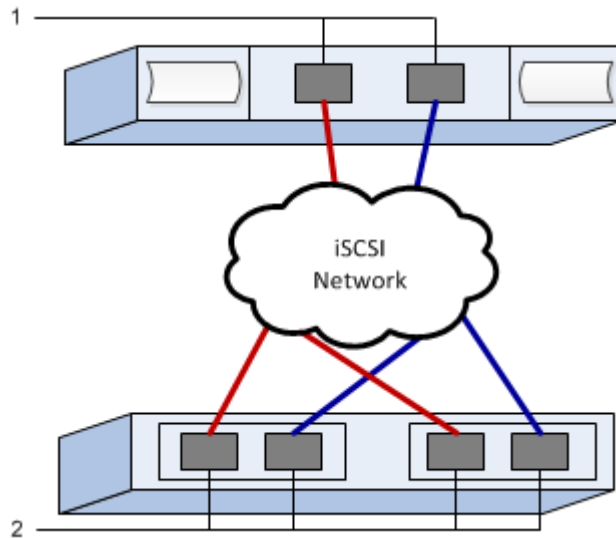

### Target IQN

Callout No.	Target port connection	IQN
2	Target port	

### Mappings host name

Callout No.	Host information	Name and type
1	Mappings host name	
	Host OS type	

## iSER over Infiniband worksheet

You can use this worksheet to record iSER over Infiniband storage configuration information. You need this information to perform provisioning tasks.

### iSER over Infiniband: Host identifiers

**Note:** The software initiator IQN is determined during the task, *Configuring storage attached hosts with iSER networking* on page 22.

Locate and document the initiator IQN from each host. For software initiators, the IQN is typically found in the `/etc/iscsi/initiatorname.iscsi` file.

Callout No.	Host port connections	Software initiator IQN
1	Host (initiator) 1	
n/a		
n/a		
n/a		
n/a		

### iSER over Infiniband: Recommended configuration

Recommended configurations consist of two host (initiator) ports and four target ports.

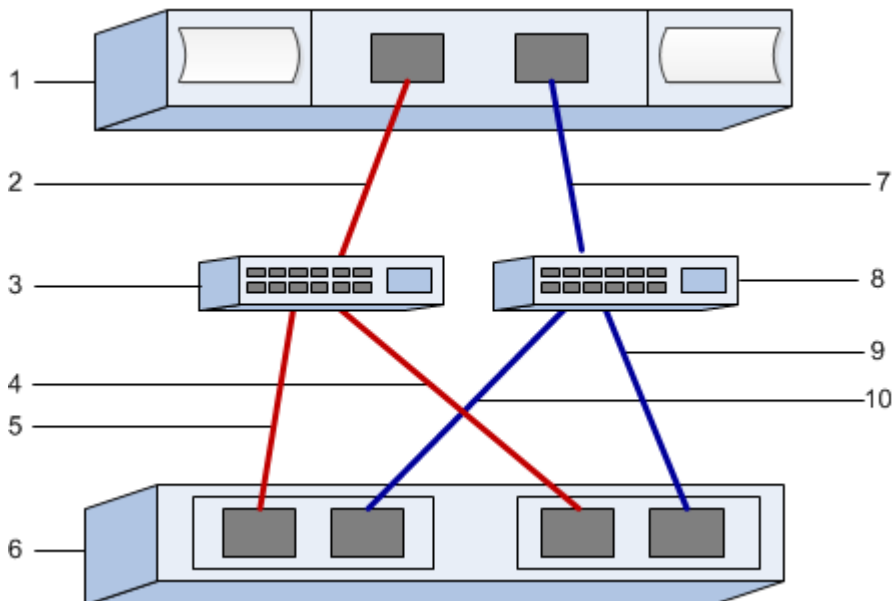

### iSER over Infiniband: Target IQN

Document the target IQN for the storage array. You will use this information in *Configuring storage attached hosts with iSER networking* on page 22.

Find the Storage Array IQN name using SANtricity: **Storage Array > iSER > Manage Settings**. This information might be necessary when you create iSER sessions from operating systems that do not support send targets discovery.

Callout No.	Array name	Target IQN
6	Array controller (target)	

### iSER over Infiniband: Network configuration

Document the network configuration that will be used for the hosts and storage on the InfiniBand fabric. These instructions assume that two subnets will be used for full redundancy.

Your network administrator can provide the following information. You use this information in the topic, [Configuring storage attached hosts with iSER networking](#) on page 22.

#### Subnet A

Define the subnet to be used.

Network Address	Netmask

Document the IQNs to be used by the array ports and each host port.

Callout No.	Array controller (target) port connections	IQN
3	Switch	<i>not applicable</i>
5	Controller A, port 1	
4	Controller B, port 1	
2	Host 1, port 1	
	(Optional) Host 2, port 1	

#### Subnet B

Define the subnet to be used.

Network Address	Netmask

Document the IQNs to be used by the array ports and each host port.

Callout No.	Array controller (target) port connections	IQN
8	Switch	<i>not applicable</i>
10	Controller A, port 2	
9	Controller B, port 2	
7	Host 1, port 2	
	(Optional) Host 2, port 2	

### iSER over Infiniband: Mapping host name

**Note:** The mapping host name is created during the workflow.



Mapping host name	
Host OS type	

## SRP over Infiniband worksheet

You can use this worksheet to record SRP over Infiniband storage configuration information. You need this information to perform provisioning tasks.

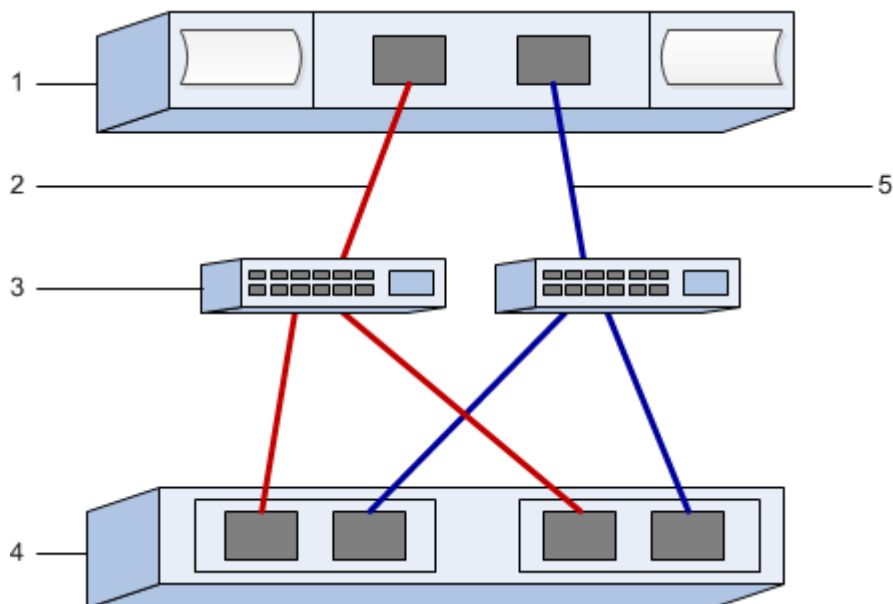

### SRP over Infiniband: Host identifiers

**Note:** The initiator GUIDs are determined in the task, [Determining host port GUIDs and making the recommended settings](#) on page 25.

Callout No.	Host (initiator) port connections	GUID
1	Host	<i>not applicable</i>
3	Switch	<i>not applicable</i>
4	Target (storage array)	<i>not applicable</i>
2	Host port 1 to IB switch 1 ("A" path)	
5	Host port 2 to IB switch 2 ("B" path)	

### SRP over Infiniband: Recommended configuration

Recommended configurations consist of two initiator ports and four target ports.

### SRP over Infiniband: Mapping host name

**Note:** The mapping host name is created during the workflow.

Mapping host name	
Host OS type	

## SAS worksheet

---

You can use this worksheet to record SAS storage configuration information. You need this information to perform provisioning tasks.

### Host Identifiers

Host (initiator) port connections	SAS address
Host (initiator) port connected to Controller A	
Host (initiator) port connected to Controller B	

### Target Identifiers

Recommended configurations consist of two target ports.

### Mappings Host

Mappings Host Name	
Host OS Type	

## Where to find additional information

---

Use the resources listed here if you need additional information. You can also use the online help for SANtricity System Manager.

- [SANtricity 11.40 Installing and Configuring for Linux Power Guide for Advanced Users](#) describes:
  - Software installation options
  - Configuration options
  - Multipath options
  - Installation on a boot device
- [Linux Unified Host Utilities 7.1 Installation Guide](#) describes how to use the Linux Unified Host Utilities 7.0.
- Online help describes how to use SANtricity System Manager to complete configuration and storage management tasks. It is available within the product and as a PDF download.
- [NetApp Knowledgebase](#) (a database of articles) provides troubleshooting information, FAQs, and instructions for a wide range of NetApp products and technologies.
- For additional documentation and instructions for E-Series products, including SANtricity software, go to the [NetApp E-Series Systems Documentation Center](#).

## Copyright information

---

Copyright © 1994–2017 NetApp, Inc. All rights reserved. Printed in the U.S.

No part of this document covered by copyright may be reproduced in any form or by any means—graphic, electronic, or mechanical, including photocopying, recording, taping, or storage in an electronic retrieval system—without prior written permission of the copyright owner.

Software derived from copyrighted NetApp material is subject to the following license and disclaimer:

THIS SOFTWARE IS PROVIDED BY NETAPP "AS IS" AND WITHOUT ANY EXPRESS OR IMPLIED WARRANTIES, INCLUDING, BUT NOT LIMITED TO, THE IMPLIED WARRANTIES OF MERCHANTABILITY AND FITNESS FOR A PARTICULAR PURPOSE, WHICH ARE HEREBY DISCLAIMED. IN NO EVENT SHALL NETAPP BE LIABLE FOR ANY DIRECT, INDIRECT, INCIDENTAL, SPECIAL, EXEMPLARY, OR CONSEQUENTIAL DAMAGES (INCLUDING, BUT NOT LIMITED TO, PROCUREMENT OF SUBSTITUTE GOODS OR SERVICES; LOSS OF USE, DATA, OR PROFITS; OR BUSINESS INTERRUPTION) HOWEVER CAUSED AND ON ANY THEORY OF LIABILITY, WHETHER IN CONTRACT, STRICT LIABILITY, OR TORT (INCLUDING NEGLIGENCE OR OTHERWISE) ARISING IN ANY WAY OUT OF THE USE OF THIS SOFTWARE, EVEN IF ADVISED OF THE POSSIBILITY OF SUCH DAMAGE.

NetApp reserves the right to change any products described herein at any time, and without notice. NetApp assumes no responsibility or liability arising from the use of products described herein, except as expressly agreed to in writing by NetApp. The use or purchase of this product does not convey a license under any patent rights, trademark rights, or any other intellectual property rights of NetApp.

The product described in this manual may be protected by one or more U.S. patents, foreign patents, or pending applications.

**RESTRICTED RIGHTS LEGEND:** Use, duplication, or disclosure by the government is subject to restrictions as set forth in subparagraph (c)(1)(ii) of the Rights in Technical Data and Computer Software clause at DFARS 252.277-7103 (October 1988) and FAR 52-227-19 (June 1987).

## Trademark information

---

Active IQ, AltaVault, Arch Design, ASUP, AutoSupport, Campaign Express, Clustered Data ONTAP, Customer Fitness, Data ONTAP, DataMotion, Element, Fitness, Flash Accel, Flash Cache, Flash Pool, FlexArray, FlexCache, FlexClone, FlexPod, FlexScale, FlexShare, FlexVol, FPolicy, Fueled by SolidFire, GetSuccessful, Helix Design, LockVault, Manage ONTAP, MetroCluster, MultiStore, NetApp, NetApp Insight, OnCommand, ONTAP, ONTAPI, RAID DP, RAID-TEC, SANscreen, SANshare, SANtricity, SecureShare, Simplicity, Simulate ONTAP, Snap Creator, SnapCenter, SnapCopy, SnapDrive, SnapIntegrator, SnapLock, SnapManager, SnapMirror, SnapMover, SnapProtect, SnapRestore, Snapshot, SnapValidator, SnapVault, SolidFire, SolidFire Helix, StorageGRID, SyncMirror, Tech OnTap, Unbound Cloud, and WAFL and other names are trademarks or registered trademarks of NetApp, Inc., in the United States, and/or other countries. All other brands or products are trademarks or registered trademarks of their respective holders and should be treated as such. A current list of NetApp trademarks is available on the web.

<http://www.netapp.com/us/legal/netapptmlist.aspx>

## How to send comments about documentation and receive update notifications

---

You can help us to improve the quality of our documentation by sending us your feedback. You can receive automatic notification when production-level (GA/FCS) documentation is initially released or important changes are made to existing production-level documents.

If you have suggestions for improving this document, send us your comments by email.

[\*doccomments@netapp.com\*](mailto:doccomments@netapp.com)

To help us direct your comments to the correct division, include in the subject line the product name, version, and operating system.

If you want to be notified automatically when production-level documentation is released or important changes are made to existing production-level documents, follow Twitter account @NetAppDoc.

You can also contact us in the following ways:

- NetApp, Inc., 495 East Java Drive, Sunnyvale, CA 94089 U.S.
- Telephone: +1 (408) 822-6000
- Fax: +1 (408) 822-4501
- Support telephone: +1 (888) 463-8277