



LTO-3 (Model B) Half-Height Tape Drive

LTO-3 (Model B)

Quantum LTO-3 Half-Height Tape Drive User's Guide, P/N 6-66843-01 Rev A, January 2010.
Product of USA.

Quantum Corporation provides this publication "as is" without warranty of any kind, either express or implied, including but not limited to the implied warranties of merchantability or fitness for a particular purpose. Quantum Corporation may revise this publication from time to time without notice.

COPYRIGHT STATEMENT

Copyright 2010 by Quantum Corporation. All rights reserved.

Your right to copy this manual is limited by copyright law. Making copies or adaptations without prior written authorization of Quantum Corporation is prohibited by law and constitutes a punishable violation of the law.

TRADEMARK STATEMENT

Quantum and the Quantum logo are registered trademarks of Quantum Corporation.

Other trademarks may be mentioned herein which belong to other companies.

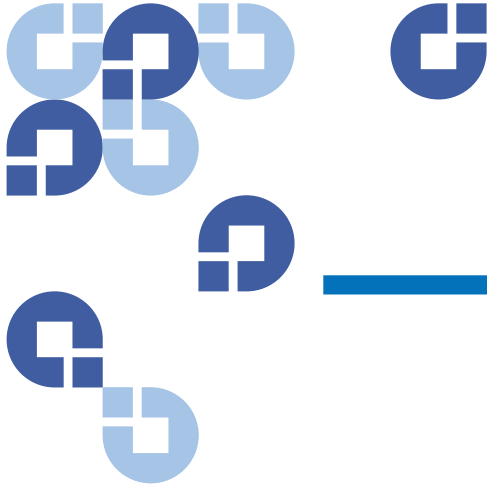

Contents

Preface	xi
----------------	-----------

Chapter 1	Introduction	1
	Overview	1
	Drive Models	2
	Internal	2
	Tabletop	2
	Features	3

Chapter 2	Installation Procedures	5
	Before Installing the LTO-3 (Model B) Half-Height Tape Drive	6
	Handling Precautions and Installation Guidelines	6
	Preinstallation Requirements	7
	Unpacking and Inspecting the Drive	8
	Installing the Internal LTO-3 (Model B) Half-Height Tape Drive	8
	Configuring the Internal Parallel SCSI Tape Drive	9
	Mounting the Internal Tape Drive	12
	Connecting the Internal Drive Interface and DC Power Cables	13
	Restarting the Internal Tape Drive System	15
	Installing the Tabletop LTO-3 (Model B) Half-Height Tape Drive	16

Configuring the Tabletop Parallel SCSI Tape Drive	16
Connecting the Tabletop Drive Interface and AC Power Cables	18
Restarting the Tabletop Drive System	22
Installing the LTO Driver Software	23
Registering the LTO-3 (Model B) Half-Height Tape Drive	23

Chapter 3	Operation	25
	Understanding the Front Panel Display	25
	Using LTO Tape Cartridges	30
	Loading a Tape Cartridge	30
	Unloading a Tape Cartridge	30
	Write Protecting a Tape Cartridge	30
	Tape Cartridge Care and Maintenance	32
	Cleaning the Tape Drive.	33
	Performing an Emergency Reset and Cartridge Eject	34

Chapter 4	Theory	35
	Track Layout	35
	Recording Method.	37
	Data Buffer	37
	Data Integrity	37
	Error-correction Code (ECC)	38
	Servo-tracking Faults.	39
	Data Compression	39
	Data Compression Considerations	40
	Intelligent Data Compression	41

Chapter 5	Specifications	43
	Physical Specifications	43
	Power Specifications	45
	Drive Performance Specifications.	46

Environmental Requirements	48
Injected Noise Specifications	49
Reliability Specifications	49
Mean Time Between Failures.	50
Mean Time to Replace.	50
LTO Cartridge Specifications	50
Environmental Considerations	50
Cartridge Memory.	51
Cartridge Reliability.	51

Chapter 6	Troubleshooting Guide	53
	Installation Best Practices	53
	Following SCSI Best Practices	53
	Using a Parallel SCSI Host Bus Adapter (HBA)	54
	Using a Serial-attached SCSI Host Bus Adapter	54
	HBA Preinstallation Checks	55
	Troubleshooting Suggestions	55
	Computer Does Not Start	55
	Computer Hardware Does Not Recognize the Tape Drive	56
	Computer Software Does Not Recognized the Tape Drive	57
	Slow Backup Operations	58
	Failed Operations TapeAlert Messages	61
	Understanding LED Sequences	67

Appendix A	Installation Checklists	71
	Internal LTO-3 (Model B) Half-Height Tape Drive Quick Start	71
	Tabletop LTO-3 (Model B) Half-Height Tape Drive Quick Start	73

Appendix B	Disposal of Electrical & Electronic Equipment	75
-------------------	----------------------------------------------------------	-----------

Appendix C	Regulatory Compliances	77
	Safety Compliances	77

Electromagnetic Compatibility (EMC) Compliances 78

Index **81**

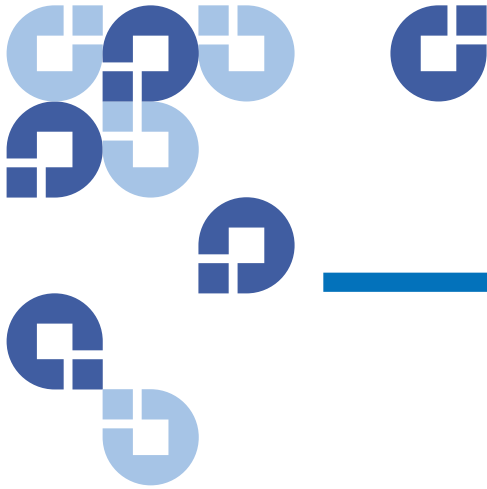

Figures

Figure 1	Internal LTO-3 (Model B) Half-Height Tape Drive	2
Figure 2	Internal Parallel SCSI ID Configuration Jumper Pins	10
Figure 3	Internal Parallel SCSI Bus Termination Examples	11
Figure 4	Acceptable Mounting Orientation	12
Figure 5	Internal Tape Drive Mounting Holes	13
Figure 6	Internal SCSI Drive Interface and DC Power Connectors	14
Figure 7	Internal SAS Drive Interface and DC Power Connectors	15
Figure 8	Tabletop Parallel SCSI ID Selector Switch	18
Figure 9	Tabletop SCSI Interface and Power Cable Connectors	19
Figure 10	Tabletop SAS Interface and Power Cable Connectors	20
Figure 11	Tabletop Parallel SCSI Bus Termination Examples	22
Figure 12	Front Panel Display	26
Figure 13	Ultrium Tape Cartridge Write-Protect Switch	31
Figure 14	Layout of the Tracks on LTO Ultrium Tapes	36
Figure 15	LTO-3 (Model B) Half-Height Tape Drive Dimensions (front)	44
Figure 16	LTO-3 (Model B) Half-Height Drive Dimensions (side)	45
Figure 17	Front Panel Display	67

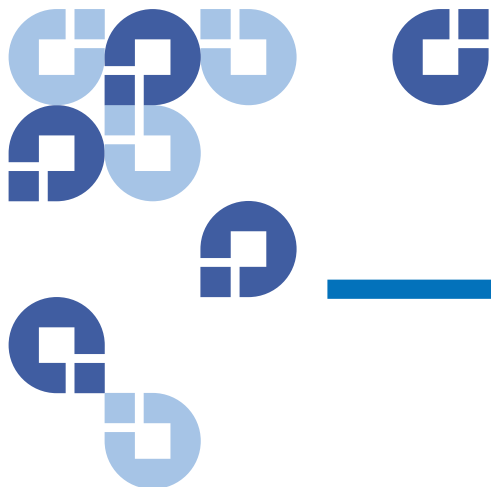

Tables

Table 1	Performance Features and Capabilities	3
Table 2	Front Panel Display LED Blink Codes	28
Table 3	Physical Specifications	44
Table 4	Voltage and Current Specifications	45
Table 5	Power Dissipation	46
Table 6	Drive Performance Specifications	46
Table 7	Environmental Requirements	48
Table 8	Reliability Specifications	49
Table 9	Environmental Tolerances	51
Table 10	Tape Drive LED Sequences	68

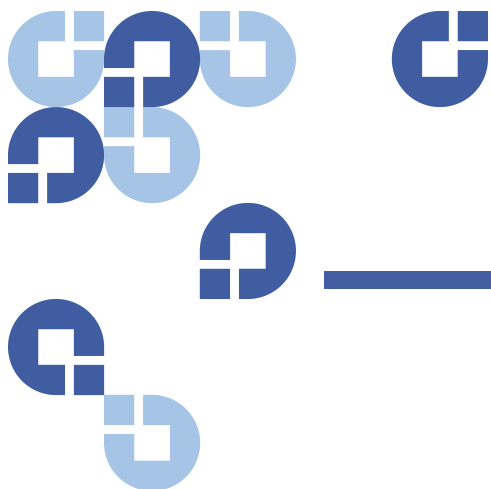

Preface

Audience

This guide is written for users of the Quantum LTO-3 (Model B) Half-Height Tape Drive. If your drive model number does not end in a -B, see Quantum.com for user documentation.

Note: The LTO-3 (Model B) tape drive can ONLY be used with the LTO-3 (Model B) drivers and firmware. To obtain the correct driver and firmware, visit <http://www.quantum.com/ServiceandSupport/Index.aspx>.

Purpose

This guide provides information about the LTO-3 (Model B) Half-Height Tape Drive including:

- Installing the drive
- Basic drive operations
- Maintenance
- Specifications
- Troubleshooting

Document Organization

This guide is organized as follows:

- [Chapter 1, Introduction](#), provides an overview of LTO and Ultrium technologies, and summarizes the drive's key features.
- [Chapter 2, Installation Procedures](#), describes handling precautions, unpacking tips, and installation instructions.
- [Chapter 3, Operation](#), describes the operation and maintenance of the drive.
- [Chapter 4, Theory](#), describes the theory of operation behind the drive, including the technology used in various drive components.
- [Chapter 5, Specifications](#), provides drive and cartridge specifications.
- [Chapter 6, Troubleshooting Guide](#) provides troubleshooting procedures you can follow if you encounter a problem with your drive.
- [Appendix A, Installation Checklists](#), provides abbreviated quick-start checklists for users who are already familiar with the installation procedures.
- [Appendix B, Disposal of Electrical & Electronic Equipment](#), provides instructions for proper disposal of unwanted electrical and electronic equipment.
- [Appendix C, Regulatory Compliances](#), identifies drive compliance with safety and EMC regulations.

This guide also has an index.

Notational Conventions

This guide uses the following conventions:

Note: Notes emphasize important information related to the main topic.

Caution: Cautions indicate potential hazards to equipment and are included to prevent damage to equipment.

WARNING: Warnings indicate potential hazards to personal safety and are included to prevent injury.

Related Documents

The following subsection identifies the primary documents that are related to the LTO-3 (Model B) Half-Height Tape Drive.

Standards Conformance

The Small Computer System Interface is described in standards that include several versions and a number of individual documents. The original Small Computer System Interface Standard, X3.131-1986, is referred to as SCSI-1. SCSI-1 was revised, resulting in the Small Computer System Interface – 2 (X3.131-1994), referred to as SCSI-2. The set of SCSI-3 standards are collectively referred to as SCSI-3. The applicable ANSI standards are as follows:

- INCITS Technical Committee T10 (SCSI Storage Interfaces) Standards:
 - SCSI Architecture Model – 2 (SAM-2) INCITS 366-2003
 - SCSI Architecture Model – 3 (SAM-3) INCITS 402-2005
 - SCSI Architecture Model – 4 (SAM-4) in development
 - Automation/Drive Interface – Commands (ADC) INCITS 403-2005
 - Automation/Drive Interface Commands (ADC-2) in development
 - Automation/Drive Interface – Transport Protocol (ADT) INCITS 406-2005
 - Automation/Drive Interface – Transport Protocol – 2 (ADT-2) in development
 - Fibre Channel Protocol for SCSI (FCP) INCITS 269-1996
 - Fibre Channel Protocol for SCSI, Second Version - 2 (FCP-2) INCITS 350-2003
 - Fibre Channel Protocol for SCSI, Third Version - 3 (FCP-3) INCITS 416-2006
 - Fibre Channel Protocol for SCSI, Fourth Version - 4 (FCP-3) in development
 - SCSI-3 Medium Changer Commands (SMC) INCITS 314-1998
 - SCSI Media Changer Commands – 2 (SMC-2) INCITS 382-2004
 - SCSI Media Changer Commands – 3 (SMC-3) in development
 - SCSI Parallel Interface – 3 (SPI-3) INCITS 336-2000

- SCSI Parallel Interface-4 (SPI-4) INCITS 362-2002
- SCSI Parallel Interface-5 (SPI-5) INCITS 367-2003
- SCSI-3 Primary Commands (SPC) INCITS 301-1997
- SCSI Primary Commands – 2 (SPC-2) INCITS 351-2001
- SCSI Primary Commands – 3 (SPC-3) INCITS 408-2005
- SCSI Primary Commands – 4 (SPC-4) in development
- SCSI-3 Stream Commands (SSC) INCITS 335-2000
- SCSI Stream Commands – 2 (SSC-2) INCITS 380-2003
- SCSI Stream Commands – 3 (SSC-3) in development
- Serial Attached SCSI – (SAS) INCITS 376-2003
- Serial Attached SCSI – 1.1 (SAS-1.1) INCITS 417-2006
- Serial Attached SCSI – 2 (SAS-2) in development
- INCITS Technical Committee T11 (Device Level Interfaces) Standards
 - Fibre Channel Arbitrated Loop (FC-AL-2) Amendment 1 INCITS 332.1999/AM1-2003
 - Fibre Channel Generic Services-4 (FC-GS-4) INCITS 387-2004
 - Fibre Channel Generic Services-5 (FC-GS-5) in development
 - Fibre Channel Generic Services-6 (FC-GS-6) in development
 - Fibre Channel - Link Services (FC-LS) in development

Note: The term “SCSI” is used wherever it is not necessary to distinguish between the versions of SCSI.

Contacts

Quantum company contacts are listed below.

Quantum Corporate Headquarters

To order documentation on the <Product Name> or other products contact:

Quantum Corporation (*Corporate Headquarters*)
1650 Technology Drive, Suite 700
San Jose, CA 95110-1382

Technical Publications

To comment on existing documentation send e-mail to:

doc-comments@quantum.com

Quantum Home Page

Visit the Quantum home page at:

<http://www.quantum.com>

Getting More Information or Help

Quantum. Global Services

StorageCare™, Quantum's comprehensive service approach, leverages advanced data access and diagnostics technologies with cross-environment, multi-vendor expertise to resolve backup issues faster and at lower cost.

Accelerate service issue resolution with these exclusive Quantum StorageCare services:

- **Service and Support Website** - Register products, license software, browse Quantum Learning courses, check backup software and operating system support, and locate manuals, FAQs, firmware downloads, product updates and more in one convenient location. Benefit today at:

<http://www.quantum.com/ServiceandSupport/Index.aspx>

- **eSupport** - Submit online service requests, update contact information, add attachments, and receive status updates via email. Online Service accounts are free from Quantum. That account can also be used to access Quantum's Knowledge Base, a comprehensive repository of product support information. Sign up today at:

<http://www.quantum.com/ServiceandSupport/eSupport/Index.aspx>

- **StorageCare Sage xTalk Management Console** - In less than thirty minutes xTalk will evaluate your tape drive's health and determine if it needs to be sent in for service. The application also provides detailed engineering drive analysis information and the ability to quickly download updates to the firmware, application, online help, test script and release notes.

<http://www.quantum.com/ServiceandSupport/SoftwareandDocumentationDownloads/Sage/Index.aspx>

For further assistance, or if training is desired, contact Quantum Customer Support Center:

United States	800-284-5101 (toll free) 949-725-2100
EMEA	00800-4-782-6886 (toll free) +49 6131 3241 1164
APAC	+800 7826 8887 (toll free) +603 7953 3010

For worldwide support:

<http://www.quantum.com/ServiceandSupport/Index.aspx>

Worldwide End-User Product Warranty

For more information on the Quantum Worldwide End-User Standard Limited Product Warranty:

<http://www.quantum.com/pdf/QuantumWarranty.pdf>

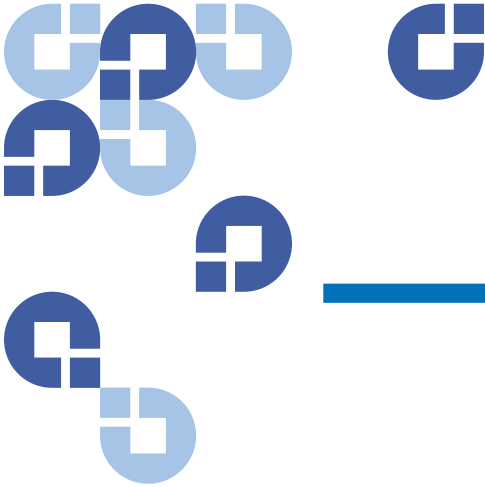

Chapter 1

Introduction

This chapter provides an introductory overview of the Quantum LTO-3 (Model B) Half-Height Tape Drive. Topics include:

- [Overview](#)
- [Drive Models](#)
- [Features](#)

Overview

The Quantum LTO-3 (Model B) Half-Height Tape Drive is a high-performance 16-channel tape drive that complies with the LTO interchange specifications. The drive is suited for mid-range to high-end servers, mainframe systems, and tape library automation systems.

The LTO-3 (Model B) Half-Height Tape Drive uses Ultrium data cartridges. Its capacity is maximized using intelligent data compression. The drive has a native capacity of 400 Gbytes (800 Gbytes assuming 2:1 data compression).

The LTO-3 (Model B) Half-Height Tape Drive has a 5¼-inch half-height form factor with automatic electromechanical cartridge soft load. It is available in two models:

- Internal

- Tabletop

Drive Models

Internal

The internal model (see [figure 1](#)) is a 5¼-inch drive that you can install inside the drive bay of a:

- Computer workstation or server system
- Quantum rackmount drive enclosure

Tabletop

The tabletop model is a 5¼-inch drive that is already mounted inside a stand-alone external drive enclosure with a built-in power supply.

Figure 1 Internal LTO-3 (Model B) Half-Height Tape Drive



Features

[Table 1](#) describes the key performance features and capabilities of the LTO-3 (Model B) Half-Height Tape Drive.

Table 1 Performance Features and Capabilities

Feature	Description
Cartridge memory	Stores pertinent information about the media to enable fast cartridge loading
Chassis	Shock damped and isolated
Data buffering	128 Mbytes for high performance
Head positioner	Patented proprietary mechanism for increased data integrity
Intelligent data compression	Analyzes compression factors before recording to maximize performance and capacity
Interfaces	Either parallel Small Computer System Interface (SCSI) or serial-attached SCSI (SAS)
LSI™ circuitry	Custom designed for fast, efficient data processing
Native data transfer rate	Up to 60 Mbytes per second native, 120 Mbytes per second compressed (2:1).
Read channel	Third generation for increased maturity and data integrity
RISC processors	Provide fast, efficient data processing
SmartVerify	Includes two levels of ECC for extra data safety and error protection
Supported platforms	A wide variety of Windows and UNIX systems
TapeAlert	Monitors and reports drive performance

Feature	Description
Tape picking	Enhanced implementation for increased reliability

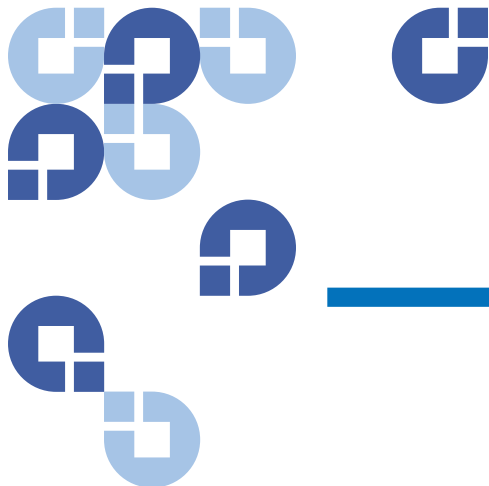

Chapter 2

Installation Procedures

This chapter provides detailed installation instructions for both the internal and tabletop models of the Quantum LTO-3 (Model B) Half-Height Tape Drive, including:

- [Before Installing the LTO-3 \(Model B\) Half-Height Tape Drive](#), which includes:
 - [Handling Precautions and Installation Guidelines](#)
 - [Preinstallation Requirements](#) on page 7
 - [Unpacking and Inspecting the Drive](#) on page 8
- Detailed procedures for:
 - [Installing the Internal LTO-3 \(Model B\) Half-Height Tape Drive](#) on page 8
 - [Installing the Tabletop LTO-3 \(Model B\) Half-Height Tape Drive](#) on page 16
 - [Installing the LTO Driver Software](#) on page 23, optional/when required
 - [Registering the LTO-3 \(Model B\) Half-Height Tape Drive](#) on page 23

Optionally, experienced users who are familiar with installing the LTO-3 (Model B) Half-Height Tape Drive can refer to the quick-start checklists in [appendix](#) on page 71 of this guide. Each checklist provides abbreviated installation instructions, with references to the corresponding detailed procedures in this chapter.

Before Installing the LTO-3 (Model B) Half-Height Tape Drive

Handling Precautions and Installation Guidelines

Always observe the following precautions and guidelines when handling and installing LTO-3 (Model B) Half-Height Tape Drives:

- Internal, at all times
- Tabletop, when removed from its free-standing enclosure

Handling Precautions

- Internal drives have exposed components that are sensitive to static electricity. To reduce the possibility of damage from static discharge, the drives are packaged in a protective antistatic bag. Do not remove the drive from the antistatic bag until you are ready to install it.
- Wear an ESD-preventive grounding wrist strap or observe similar ESD precautions when working with the drive. Be sure the wrist strap makes good skin contact. Do not remove the wrist strap until you finish working with the drive.
Also, avoid contact between the drive, other equipment, and clothing. The wrist strap only protects the equipment from ESD voltages on the body; ESD voltages on clothing can still cause damage.
- Before removing the drive from the antistatic bag, touch a grounded metal surface to discharge any static electricity buildup from your body.

(continued)

Handling Precautions (continued)	<ul style="list-style-type: none">• Handle the drive by its sides rather than by the top cover to reduce the risk of dropping the drive or damaging it during installation.• Either lay the drive on a nonconductive surface or put it back inside the protective antistatic bag to reduce the chance of damage from static discharge
Installation Guidelines	<ul style="list-style-type: none">• LTO-3 (Model B) Half-Height Tape Drives with the parallel SCSI interface are low voltage differential (LVD) SCSI devices. Install LVD drives only in LVD environments. Do not mix LVD and HVD devices on the same parallel SCSI bus.• Due to the high speed of the LTO-3 (Model B) Half-Height Tape Drive, do not connect more than one LTO-3 (Model B) drive to the same channel on a host SCSI adapter.

Preinstallation Requirements

Before installing the LTO-3 (Model B) Half-Height Tape Drive, make sure you have:

- A host bus adapter (HBA) installed and properly configured in the host computer:
 - Parallel SCSI HBA for a parallel SCSI drive
 - Serial SCSI HBA for a SAS drive
- Interface components:
 - For a parallel SCSI drive, either internal or tabletop, a 68-pin parallel SCSI cable and terminator
 - For a SAS drive, either:
 - 29-pin SFF-8482 SAS style interface cable for an internal drive

- 26-pin SFF-8088 mini-SAS style interface cable for a tabletop drive
- Backup application software that supports the tape drive. For a list of the backup software applications that have been tested with the LTO-3 (Model B) Half-Height Tape Drive, please visit our website at:
www.quantum.com/support

Unpacking and Inspecting the Drive

Although each LTO-3 (Model B) Half-Height Tape Drive is inspected and carefully packaged at the factory, damage can occur:

- In shipment
- When being unpacked

Observe the handling precautions listed in [Handling Precautions and Installation Guidelines](#) and carefully unpack and inspect the LTO-3 (Model B) Half-Height Tape Drive as follows:

- 1 Visually inspect the shipping container and notify your carrier immediately of any damage.
- 2 Place the shipping container on a flat, clean, stable surface and carefully remove the contents.
- 3 Visually inspect the LTO-3 (Model B) Half-Height Tape Drive and notify your Quantum representative immediately of any damage.
- 4 Always save the shipping container and packing materials for any future reshipment.

Installing the Internal LTO-3 (Model B) Half-Height Tape Drive

To install the internal LTO-3 (Model B) Half-Height Tape Drive, complete the following procedures in the order presented:

1 Depending on the interface configuration of the drive:

IF the drive interface is . . .	THEN . . .
parallel Small Computer System Interface (SCSI),	proceed to Configuring the Internal Parallel SCSI Tape Drive in the following subsection to configure the parallel SCSI ID and bus terminator power.
serial-attached SCSI (SAS),	there is no need to configure the SCSI ID or bus termination, as SAS is a point-to-point architecture. Skip to Mounting the Internal Tape Drive on page 12

- 2 [Connecting the Internal Drive Interface and DC Power Cables](#) on page 13.
- 3 [Restarting the Internal Tape Drive System](#) on page 15
- 4 [Installing the LTO Driver Software](#) on page 23, if required.
- 5 [Registering the LTO-3 \(Model B\) Half-Height Tape Drive](#) on page 23.

Configuring the Internal Parallel SCSI Tape Drive

The factory-set default configuration of the internal parallel SCSI LTO-3 (Model B) Half-Height Tape Drive is:

- SCSI ID: 6
- Terminator power: enabled

IF the default parallel SCSI ID configuration is . . .	THEN you can . . .
compatible with your system SCSI bus,	skip the following subsection and proceed to Configuring the Internal Parallel SCSI Terminator Power on page 10.
already assigned to another device,	change the configuration of either the other device, or the LTO-3 (Model B) Half-Height Tape Drive, as described in the following subsection.

Configuring the Internal Drive Parallel SCSI ID

Each device on the parallel SCSI bus must have its own unique SCSI ID. Use SCSI configuration jumper pins 1–2, 3–4, 5–6, and 7–8 on the drive back panel to change the SCSI ID of the LTO-3 (Model B) Half-Height Tape Drive (see [figure 2](#)).

Note: Parallel SCSI controllers and host adapters generally use ID 7. In some systems, the boot drive uses ID 0 or ID 1. Avoid configuring the LTO-3 (Model B) Half-Height Tape Drive to these SCSI IDs.

Figure 2 Internal Parallel SCSI ID Configuration Jumper Pins

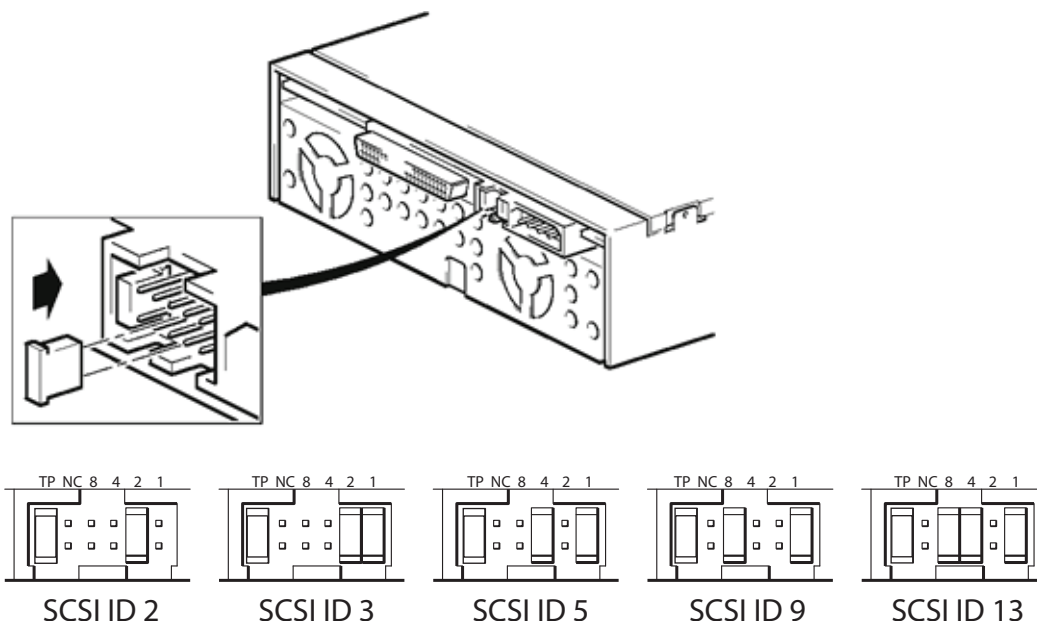

Configuring the Internal Parallel SCSI Terminator Power

By default, terminator power is enabled on the internal parallel SCSI LTO-3 (Model B) Half-Height Tape Drive. If you use this default setting, then the last device at the end of the parallel SCSI bus must have either:

- A parallel SCSI bus terminator
- Terminator power enabled

See [figure 3](#) for examples of internal parallel SCSI bus termination.

To disable terminator power, remove the termination power (TP) jumper (see [figure 2](#)).

Note: The internal parallel SCSI LTO-3 (Model B) Half-Height Tape Drive does not provide SCSI termination. The last device at the end of the parallel SCSI bus chain must have a SCSI bus terminator.

Figure 3 Internal Parallel SCSI Bus Termination Examples

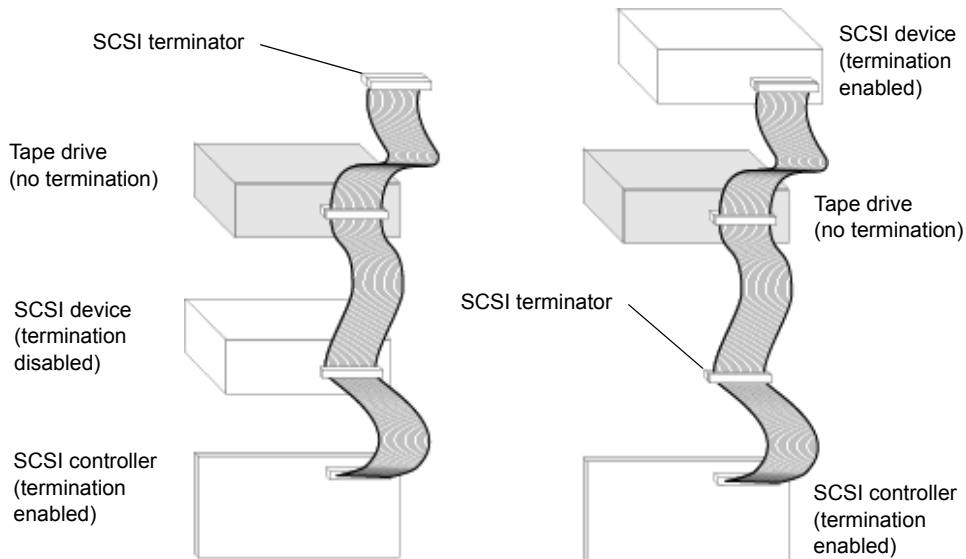

Mounting the Internal Tape Drive

You can mount the internal LTO-3 (Model B) Half-Height Tape Drive either horizontally or vertically, but not upside down (see [figure 4](#)).

IF you mount the drive . . .	THEN the . . .
horizontally,	base of the drive must be within 15 degrees of horizontal.
vertically,	side of the drive should be within 5 degrees of horizontal.

Figure 4 Acceptable Mounting Orientation

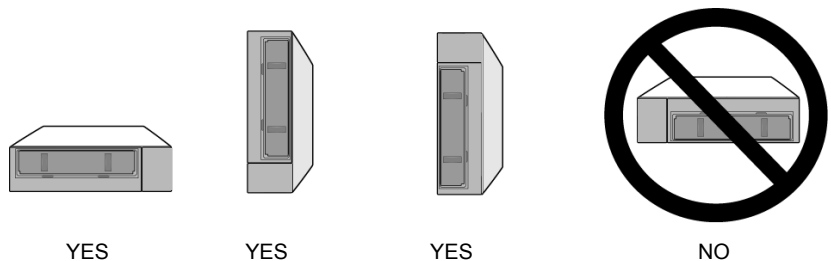

Mount the drive in a 5.25-inch, half-height drive bay as follows:

- 1 As required:
 - a Save and close your open files and terminate all running applications.
 - b Shut down the workstation or server system.
 - c Disconnect the system AC power cord from the facility AC power receptacle.
- 2 Remove the cover from the workstation or server system.

Note: See your computer manufacturer's instructions for the proper procedures to remove the cover.

- 3 Select an available 5.25-inch half-height bay and, if required, remove the bay cover.
- 4 Position the drive in the bay and align either the upper or lower mounting holes—whichever is appropriate—with the holes in the chassis (see figure 5).

- 5 Secure the drive using two M3.0 X 3 metric screws on each side.

Caution: Using screws longer than 3 mm can damage the drive.
Do not use screws longer than 3 mm to secure the internal LTO-3 (Model B) Half-Height Tape Drive.

After mounting the internal LTO-3 (Model B) Half-Height Tape Drive, proceed to [Connecting the Internal Drive Interface and DC Power Cables](#) in the following subsection.

Figure 5 Internal Tape Drive Mounting Holes

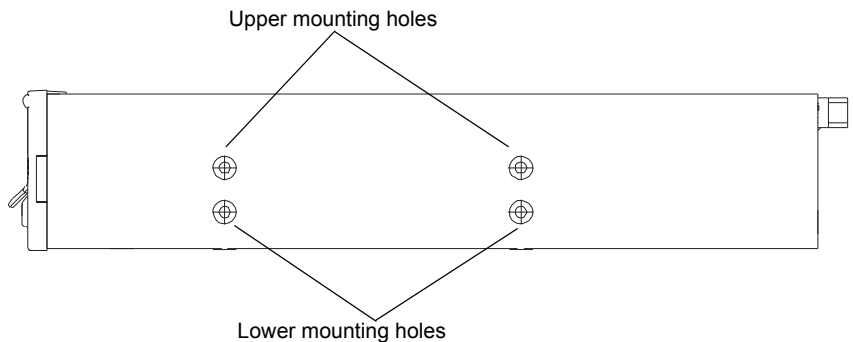

Connecting the Internal Drive Interface and DC Power Cables

As shown in [figure 6](#) and [figure 7](#), the rear panels of the internal LTO-3 (Model B) Half-Height Tape Drives have connectors for:

- Either a 68-pin parallel SCSI or a 29-pin SFF-8482 SAS style interface cable
- A serial library interface cable
- The internal drive DC power cable

Connect the interface and DC power cables to the internal drive as follows:

- 1 Verify that the system is shut down and the AC power cord is disconnected from the facility AC power receptacle.
- 2 Depending on the interface configuration of your internal drive:
 - a For the parallel SCSI internal drive:

- Attach the internal parallel SCSI interface cable to the 68-pin parallel SCSI connector on the back of the drive.

Caution: The LTO-3 (Model B) Half-Height Tape Drive with the parallel SCSI interface is a low voltage differential (LVD) SCSI device. Install it only in LVD environments. Plugging an LVD drive into a high voltage differential (HVD) bus makes the entire bus nonfunctional and may permanently damage the drive or other SCSI devices on the bus.

- See the internal parallel SCSI bus termination examples in [figure 3](#) on page 11 to check/verify the system SCSI bus configuration and install a 68-pin LVD SCSI bus terminator as required.
- b** For the SAS internal drive, attach the internal SAS interface cable to the 29-pin SFF-8482 SAS connector on the back of the drive.

Figure 6 Internal SCSI Drive Interface and DC Power Connectors

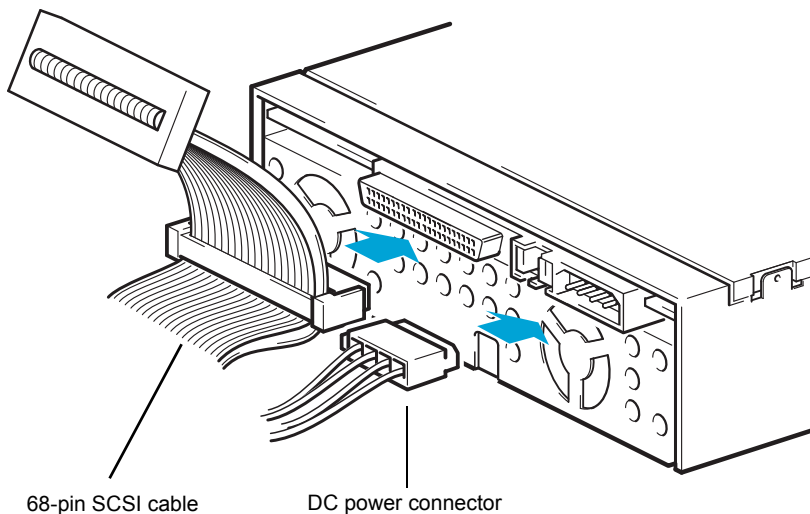
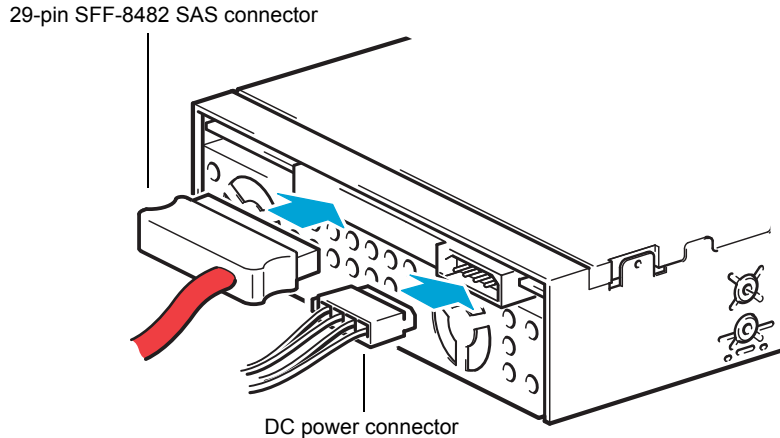

Figure 7 Internal SAS Drive Interface and DC Power Connectors



- 3 If you are installing the internal LTO-3 (Model B) Half-Height Tape Drive in a tape library system, connect the RS-422 serial interface cable to the serial library port on the back of the drive. (The serial library port is not used on workstation or server systems.)
- 4 Connect the internal drive DC power cable to the DC power connector on the back of the drive.
- 5 Reinstall the system cover.
- 6 Reconnect the system AC power cord to the facility AC power receptacle.

After connecting the interface and DC power cables, proceed to [Restarting the Internal Tape Drive System](#) in the following subsection.

Restarting the Internal Tape Drive System

After connecting the internal drive interface and DC power cables:

- 1 Restart the workstation or server system.
- 2 Refer to the operating procedures in [chapter 3](#) to verify that the internal LTO-3 (Model B) Half-Height Tape Drive comes on and completes the Power On Self Test (POST) functions.
- 3 As required, proceed to either:
 - [Installing the LTO Driver Software](#) on page 23
 - [Registering the LTO-3 \(Model B\) Half-Height Tape Drive](#) on page 23

Installing the Tabletop LTO-3 (Model B) Half-Height Tape Drive

The tabletop LTO-3 (Model B) Half-Height Tape Drive is a compact external drive that connects to the host computer through an external parallel SCSI port or an external serial-attached SCSI (SAS) port.

Do not attempt to install the LTO-3 (Model B) Half-Height Tape Drive until you have reviewed [Handling Precautions and Installation Guidelines](#) on page 6.

To install the tabletop LTO-3 (Model B) Half-Height Tape Drive, complete the following procedures in the order presented:

- 1 Depending on the interface configuration of the drive:

IF the drive interface is . . .	THEN . . .
parallel Small Computer System Interface (SCSI),	proceed to Configuring the Tabletop Parallel SCSI Tape Drive in the following subsection to configure the SCSI ID.
serial-attached SCSI (SAS),	there is no need to configure the SCSI ID, as SAS is a point-to-point architecture. Skip to Connecting the Tabletop Drive Interface and AC Power Cables on page 18.

- 2 [Connecting the Tabletop Drive Interface and AC Power Cables](#) on page 18.
- 3 [Restarting the Tabletop Drive System](#) on page 22.
- 4 [Installing the LTO Driver Software](#) on page 23, if required.
- 5 [Registering the LTO-3 \(Model B\) Half-Height Tape Drive](#) on page 23.

Configuring the Tabletop Parallel SCSI Tape Drive

The factory-set default configuration of the tabletop parallel SCSI LTO-3 (Model B) Half-Height Tape Drive is:

- SCSI ID: 6

- Terminator power: enabled

IF the default parallel SCSI ID configuration is . . .

THEN you can . . .

compatible with your system
SCSI bus,

skip the following subsection and proceed to [Connecting the Tabletop Drive Interface and AC Power Cables](#) on page 18.

already assigned to another device,

change the configuration of either the other device, or the LTO-3 (Model B) Half-Height Tape Drive, as described in the following subsection.

Note: You cannot disable terminator power on a tabletop parallel SCSI drive.

Configuring the Tabletop Drive Parallel SCSI ID

Each device on the parallel SCSI bus must have its own unique SCSI ID. Use the push-button SCSI ID selector switch on the drive back panel to change the SCSI ID of the tabletop LTO-3 (Model B) Half-Height Tape Drive (see [figure 8](#)).

Figure 8 Tabletop Parallel
SCSI ID Selector Switch

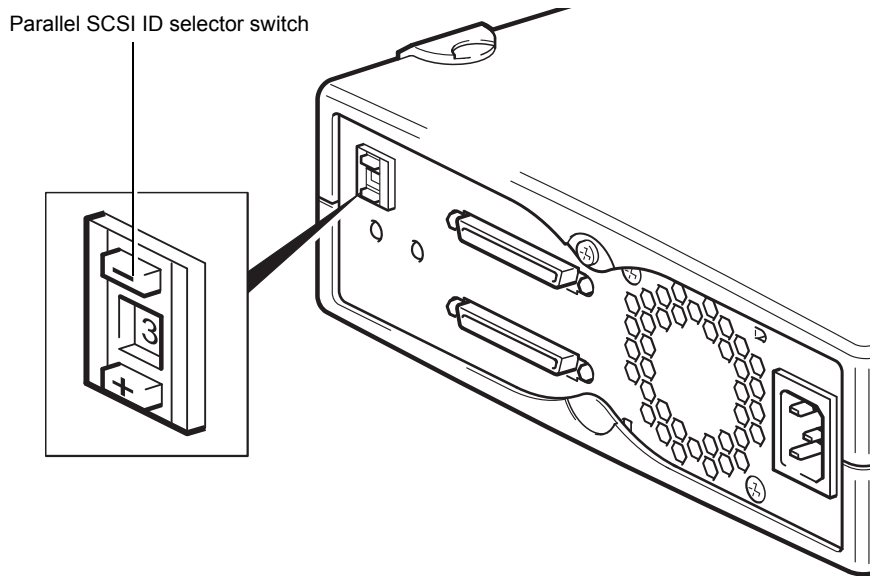

Note: Parallel SCSI controllers and host adapters generally use ID 7. In some systems, the boot drive uses ID 0 or ID 1. Avoid configuring the LTO-3 (Model B) Half-Height Tape Drive to these SCSI IDs.

After configuring the parallel SCSI ID, proceed to [Connecting the Tabletop Drive Interface and AC Power Cables](#) in the following subsection.

Connecting the Tabletop Drive Interface and AC Power Cables

As shown in [figure 9](#) and [figure 10](#), the rear panels of the tabletop LTO-3 (Model B) Half-Height Tape Drives have connectors for:

- Either a 68-pin parallel SCSI cable (two connectors), or a 26-pin SFF-8088 mini-SAS style interface cable
- The AC power cable

For the tabletop parallel SCSI drive, either SCSI connector can be used as a SCSI IN or SCSI OUT connection. This means you can use either connector to attach the drive to a host computer or to another parallel SCSI device.

Figure 9 Tabletop SCSI
Interface and Power Cable
Connectors

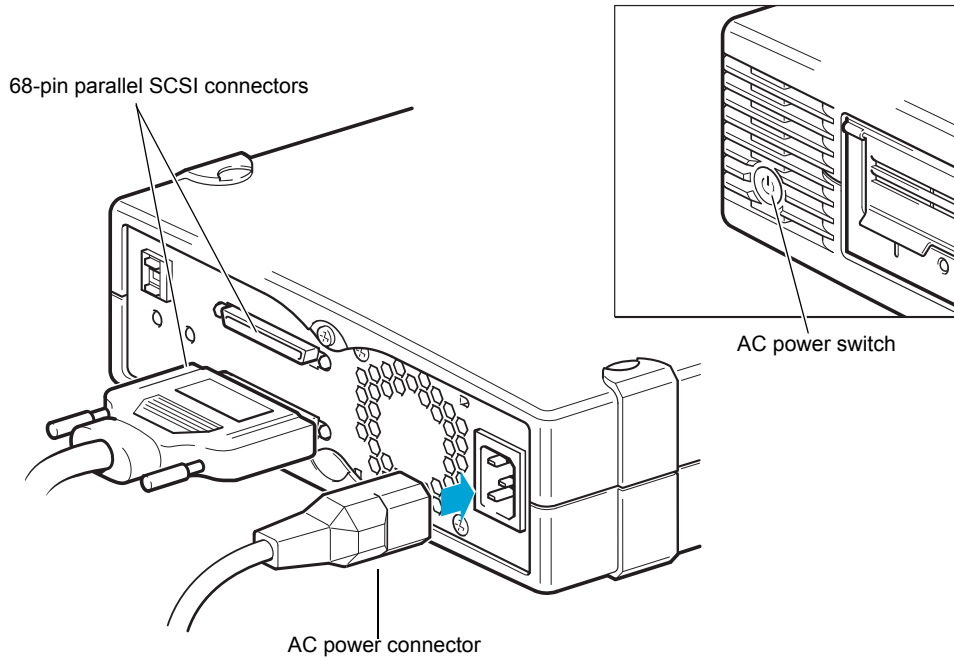
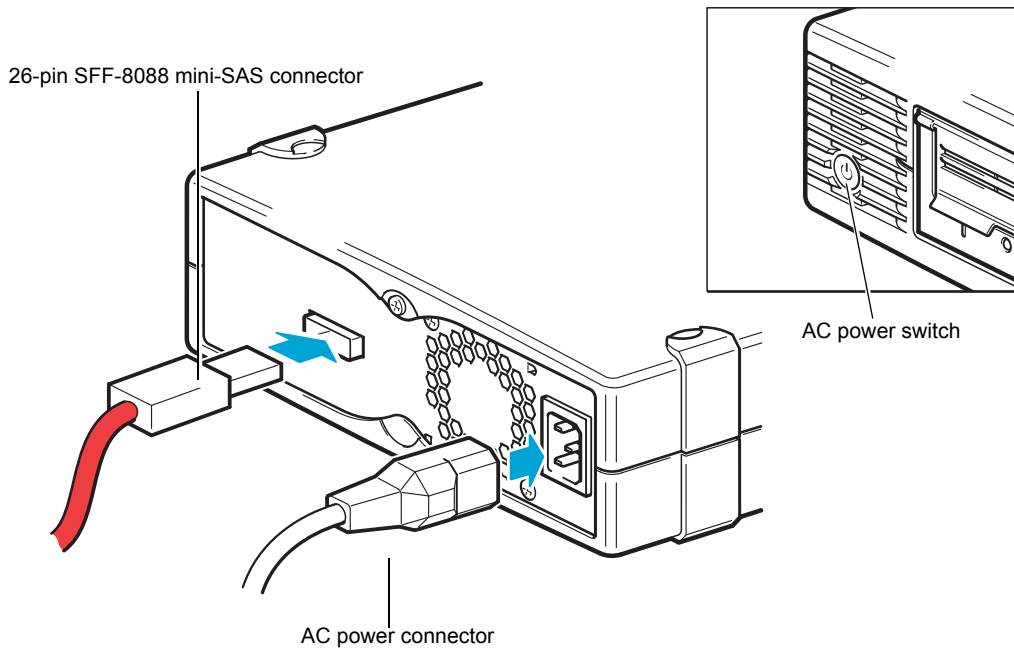

Figure 10 Tabletop SAS
Interface and Power Cable
Connectors



Connect the interface and AC power cables to the tabletop drive as follows:

- 1 As required:
 - a Save and close your open files and terminate all running applications.
 - b Shut down the workstation or server system.
 - c Disconnect the system AC power cord from the facility AC power receptacle.
- 2 Depending on the interface configuration of your tabletop drive:
 - a For the parallel SCSI tabletop drive:
 - Attach the SCSI IN interface cable to one of the 68-pin parallel SCSI interface connectors on the back of the drive.

- Attach either the SCSI OUT interface cable or a SCSI terminator to the other parallel SCSI interface connector on the back of the drive.

If the tabletop LTO-3 (Model B) Half-Height Tape Drive is the last or only device in a SCSI chain, you must install a 68-pin low voltage differential (LVD) terminating plug on the unused parallel SCSI connector.

See [figure 11](#) for tabletop parallel SCSI bus termination examples.

Caution: The LTO-3 (Model B) Half-Height Tape Drive with the parallel SCSI interface is a low voltage differential (LVD) SCSI device. Install it only in LVD environments. Plugging an LVD drive into a high voltage differential (HVD) bus makes the entire bus nonfunctional and may permanently damage the drive or other SCSI devices on the bus.

- b** For the SAS tabletop drive, attach the external SAS interface cable to the 26-pin SFF-8088 mini-SAS connector on the back of the drive.
- 3** Verify that the tabletop LTO-3 (Model B) Half-Height Tape Drive AC power switch is set to the off position, and connect the AC power cord to the power connector on the back of the drive.
- 4** Connect the drive AC power cord to the facility AC power receptacle.
- 5** Reconnect the workstation or server system AC power cord to the facility AC power receptacle.

After connecting the tabletop drive interface and AC power cables, proceed to [Restarting the Tabletop Drive System](#) in the following subsection.

Figure 11 Tabletop Parallel
SCSI Bus Termination Examples

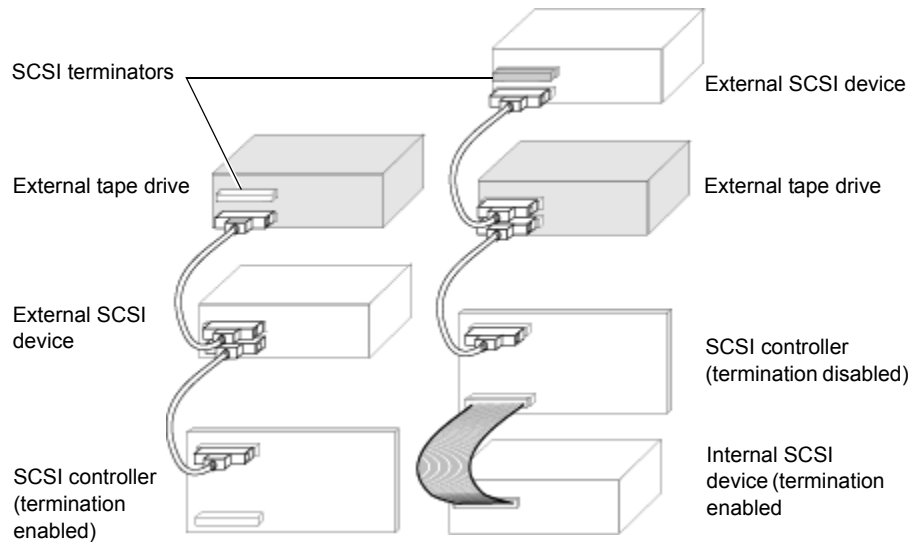

Example 1: SCSI termination in a system that has only external SCSI devices.

Example 2: SCSI termination in a system that has both internal and external SCSI devices.

Restarting the Tabletop Drive System

- After connecting the tabletop drive interface and AC power cables:
 - 1 Set the tabletop LTO-3 (Model B) Half-Height Tape Drive power switch to the on position.
 - 2 Restart the workstation or server system.
 - 3 Refer to the operating procedures in [chapter 3](#) to verify that the tabletop LTO-3 (Model B) Half-Height Tape Drive comes on and completes the Power On Self Test (POST) functions.

As required, proceed to either:

- [Installing the LTO Driver Software](#)
- [Registering the LTO-3 \(Model B\) Half-Height Tape Drive](#)

Installing the LTO Driver Software

Note: The LTO-3 (Model B) tape drive can ONLY be used with the LTO-3 (Model B) drivers and firmware. To obtain the correct driver and firmware, visit <http://www.quantum.com/ServiceandSupport/Index.aspx>.

If you intend to use the LTO-3 (Model B) Half-Height Tape Drive with the Microsoft® native backup applet on a Windows 2000, Windows Server® 2003, Windows XP®, or Windows Vista operating system, install the appropriate version of the LTO driver software. (See the Downloads page for LTO-3 (Model B) drivers under Standalone Tape Drives on the Quantum support website at www.quantum.com/support.)

Note: The LTO driver software is not necessary with commercial backup application software.

Registering the LTO-3 (Model B) Half-Height Tape Drive

After installing the LTO-3 (Model B) Half-Height Tape Drive, be sure to register it via the Quantum website at:

www.quantum.com/registration

Registering the drive ensures that you will receive the latest technical information about the drive, as well as other product, service, and support information.

Chapter 2 Installation Procedures
Registering the LTO-3 (Model B) Half-Height Tape Drive

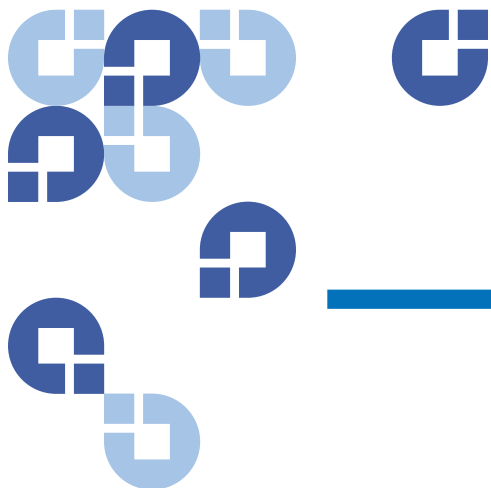

Chapter 3 Operation

This chapter describes how to operate the LTO-3 (Model B) Half-Height Tape Drive.

Topics covered in this chapter are:

- [Understanding the Front Panel Display](#)
- [Using LTO Tape Cartridges](#) on page 30
- [Cleaning the Tape Drive](#) on page 33
- [Performing an Emergency Reset and Cartridge Eject](#) on page 34

Understanding the Front Panel Display

As shown in [figure 12](#), the LTO-3 (Model B) Half-Height Tape Drive front panel display has four LED indicators that reflect the operating condition of the drive:

The LEDs are either on steady or blinking at different rates in various combinations to indicate the various drive conditions as shown in [table 2](#).

Figure 12 Front Panel Display



Clean	First LED - Orange. Indicates whether the drive needs cleaning.	
	Off	Cleaning not required
	On	Cleaning cartridge being used. The Ready LED flashes.
	Flashing	Cleaning needed. The LED continues to flash if the drive is power cycled, and will only go out after a supported cleaning tape has been used.
Tape	Second LED - Orange. Indicates tape problems	
	Off	No fault
	Flashing	Current tape is faulty, such as unreadable cartridge memory or unsupported type. Do not use the cartridge; replace it. The LED will go out when a tape load begins.

Drive	Third LED - Orange. Indicates drive problems	
	Off	No fault
	Flashing	Unrecoverable hardware failure. A power cycle or successful tape load will turn the LED off, but the LED will start flashing again if the same operation is performed and the hardware fault is still present.
Ready	Fourth LED - Green, indicates power and activity:	
	Off	Power off or self-test failure
	On	Powered on and ready for use, but no activity
	Flashing	Engaged in activity, such as responding to Read, Write, or Space commands or performing a self-test.
	Fast flash	Downloading firmware

Table 2 Front Panel Display
LED Blink Codes

LED Condition	Action Required
<p>All LEDs OFF. Drive may not have power, may be faulty or may have been power cycled or reset during a firmware upgrade.</p>	<p>Ensure the drive is switched on. If the green LED on the power switch is not on, check the power cable and replace it if necessary. If the drive has just been switched on or reset, the LED pattern should change after 1 second. If not, the drive has Firmware Image Corruption (caused by being switched off or reset during firmware upgrade). Return it to the factory for repair or reprogramming. If power is present and all LEDs remain off, try performing an interface operations (SCSI or ADI). If the drive does not respond, perform an emergency reset press the emergency reset or power-cycle the drive. If it still fails, call for service.</p>
<p>Ready and Clean OFF. Drive Error and Tape Error FLASHING. The drive has failed to execute power-on self test (POST).</p>	<p>Power cycle or reset the drive. If the condition reappears, call for service.</p>
<p>Ready ON. The drive is ready for operation.</p>	<p>None. This is normal.</p>
<p>Ready FLASHING. The drive is carrying out a normal activity (read, write).</p>	<p>None. If the drive is upgrading firmware, do not reset or power cycle it.</p>
<p>Ready FLASHING fast. (The other LEDs may be flashing) The drive is downloading firmware.</p>	<p>None. Do not reset or power cycle the drive.</p>

LED Condition	Action Required
<p>Ready OFF, others ON. Firmware is being reprogrammed.</p>	<p>None. Do not reset or power cycle the drive.</p>
<p>Clean FLASHING. (Other LEDs may be flashing.) The drive requires cleaning.</p>	<p>Load an Ultrium Universal cleaning cartridge to clean the heads. If the Clean LED is still flashing when you load a new or known data cartridge after cleaning, call for service.</p>
<p>Ready FLASHING and Clean ON. (Other LEDs may be flashing.) Cleaning is in progress.</p>	<p>None. The cleaning cartridge will eject on completion. The cleaning cycle can take up to 3 minutes.</p>
<p>Tape Error FLASHING. (Other LEDs may be flashing.) The drive believes the current tape or the tape just ejected is faulty.</p>	<p>Unload the tape cartridge. Make sure that it is a valid format: an Ultrium data cartridge or Ultrium universal cleaning cartridge. Reload the cartridge. If the Tape Error LED still flashes or starts flashing during the next backup, load a new or known, good cartridge. If the Tape Error LED is now off, discard the 'suspect' tape cartridge. If it is still on, call for service.</p>
<p>Tape ejects immediately and Tape Error FLASHES The tape cartridge memory (CM) may be faulty.</p>	<p>Write-protect the cartridge by sliding the red switch on the cartridge. The tape can be loaded and the data read. Once the data is recovered, discard the cartridge.</p>
<p>Drive Error FLASHING. (Other LEDs may be flashing.) The drive mechanism has detected an error.</p>	<p>Load a new cartridge. If the error persists, power cycle or reset the drive. If the Drive Error LED remains on, call for service.</p>
<p>Drive Error and Ready ON with Tape Error and Clean OFF. Sequence alternates repeatedly. The drive has a firmware error.</p>	<p>Power cycle or reset the drive. If the sequence reoccurs, upgrade the firmware. If the condition persists, call for service.</p>

Using LTO Tape Cartridges

Loading a Tape Cartridge

To load an Ultrium tape cartridge into the LTO-3 (Model B) Half-Height Tape Drive, gently insert the cartridge into the slot and then either:

- Push the cartridge further into the drive until the drive senses the cartridge and automatically completes the load operation.
- Use a library or host command to complete the load operation.

Unloading a Tape Cartridge

To unload an Ultrium tape cartridge from the LTO-3 (Model B) Half-Height Tape Drive, either:

- Use a library or host command to unload the tape.
- Press the **Eject** button on the front panel of the drive.

Caution: After you press the **Eject** button, several minutes can elapse before the drive ejects the cartridge. Do not power down the tape drive or the host computer until the drive has completely ejected the cartridge.

Write Protecting a Tape Cartridge

Ultrium tape cartridges have a sliding write-protect switch at the right-rear corner as shown in [figure 13](#).

Sliding the write-protect switch toward the . . .	Enables data to be . . .
center of the cartridge (the Locked position),	read from the cartridge, but not written to it. (This is the write-protected position.)
corner of the cartridge (the Unlocked position),	both read from and written to the cartridge. (This is the write-enabled position.)

Figure 13 Ultrium Tape
Cartridge Write-Protect Switch

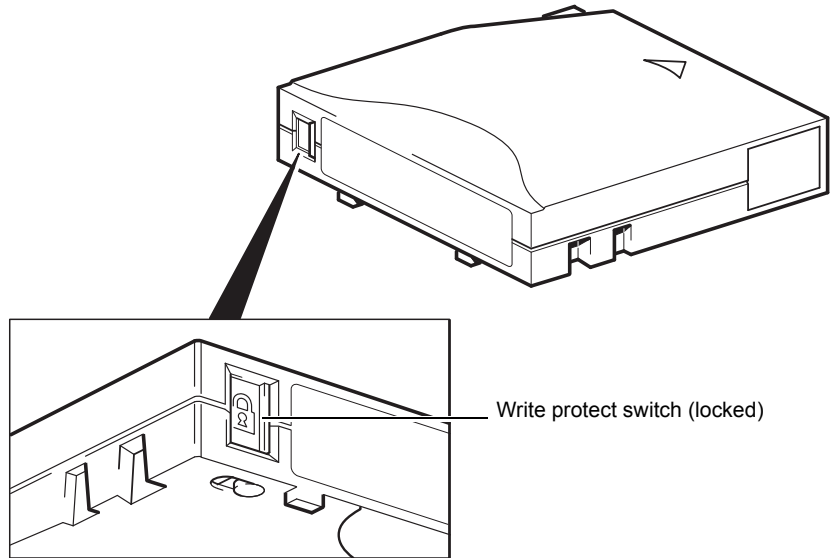

Tape Cartridge Care and Maintenance

Observe the following precautions to protect the data on your Ultrium tape cartridges:

Always:

- Remove the cartridge from the drive when not in use and store it in its protective case.
- Avoid dropping the cartridge. This can damage components inside the cartridge, possibly rendering the tape unusable. If you drop a tape cartridge, open the cartridge door and make sure that the leader pin is in the correct position.
- Re-tension a dropped cartridge before using.
- Keep the cartridge away from:
 - Direct sunlight and heat sources, such as radiators, heaters, or warm air ducts.
 - Sources of electromagnetic fields, such as telephones, computer monitors, dictation equipment, mechanical or printing calculators, motors, magnetic tools, and bulk erasers.

Do not:

- Expose the cartridge to dirt, dust or moisture.
- Touch the tape media within the cartridge.
- Bulk erase Ultrium tape cartridges. LTO tape cartridges have prewritten servo patterns that cannot be reformatted by the tape drive. A bulk erase operation would make them unusable.
- Use tape cartridges outside the specified operating conditions: 10° C to 40° C, 20% to 80% relative humidity.

If a tape cartridge has been exposed to conditions outside the specified range, recondition the tape before using in the operating environment by exposing it to the operating environment for a time equal to or greater than the time it was outside the operating environment, up to a maximum of 24 hours. Then re-tension the tape to stabilize the tape pack for better performance.

Cleaning the Tape Drive

Excessive tape debris or other material can accumulate on the tape heads if the drive is:

- Used with non-approved media
- Operated in a hot, dusty environment

When this happens, the drive can experience excessive errors while reading or writing, and illuminate the amber Status LED continuously during operation. This means that the drive needs to be cleaned.

The LTO cleaning cartridge has the same dimensions as the tape cartridge and contains an LTO Cartridge Memory (LTO-CM), but is loaded with cleaning media instead of recording media. Always keep the LTO cleaning cartridge in its protective case when not in use.

Procedure

To clean the LTO-3 (Model B) Half-Height Tape Drive:

- 1 Load an Ultrium Universal Cleaning cartridge into the tape drive.
- 2 The drive will carry out its cleaning cycle and eject the cartridge on completion (which can take up to 5 minutes). During the cleaning cycle the orange **Clean LED** will be on solidly and the green **Ready LED** will flash.

Each Ultrium universal cleaning cartridge cleaning cartridge can be used up to 50 times with Ultrium tape drives. If the cleaning cartridge is ejected immediately with the **Tape LED** on, it has expired.

Note: If the LTO-3 (Model B) Tape Drive does not recognize the cartridge as an LTO cleaning cartridge, the drive stops the cleaning process and ejects the cartridge.

- 3 After the cleaning process completes, depending on the drive configuration, either:
 - a The drive automatically ejects the Ultrium Universal Cleaning cartridge, or
 - b You must press the **Eject** button to eject the Ultrium Universal Cleaning cartridge.

- 4 Write the date on the Ultrium Universal Cleaning label for future reference.

Always discard used-up Ultrium Universal Cleaning cartridges.

Performing an Emergency Reset and Cartridge Eject

If the LTO-3 (Model B) Half-Height Tape Drive stops communicating with the host computer, use the following procedure to reset the drive and eject a cartridge (if necessary).

Caution: When you perform an emergency reset and cartridge eject, any data in the drive or host buffers will not be written to the tape and the tape record may not be correctly terminated with an end-of-data mark. If the end-of-data mark is not written to the tape, you will not be able to append any data to that tape unless you overwrite the existing data on the tape.

To perform an emergency reset, hold down the Eject button between 5 to 15 seconds, and then release it.

IF there is . . .	THEN the tape drive firmware . . .
no tape in the drive,	restarts the drive and begins the Power On Self Test function.
a tape in the drive,	ignores all outstanding SCSI commands, ejects the tape, restarts the drive, and begins the Power On Self Test function.

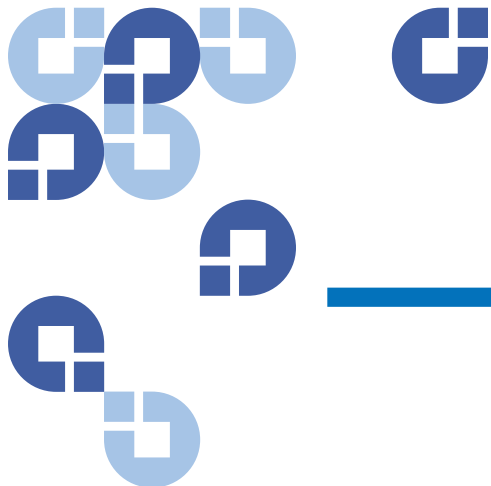

Chapter 4 Theory

This chapter describes operational theories used in the LTO-3 (Model B) Half-Height Tape Drive.

The topics covered in this chapter are:

- [Track Layout](#)
- [Recording Method](#) on page 37
- [Data Buffer](#) on page 37
- [Data Integrity](#) on page 37
- [Data Compression](#) on page 39

Track Layout

With the LTO-3 (Model B) Half-Height Tape Drive, there are 704 data tracks on the LTO tape, numbered 0 through 703. Data track 703 is the track closest to the bottom edge of the tape (the reference edge).

The area between adjacent servo bands is a data band. There are 4 data bands, each of which includes 176 data tracks. The data bands are numbered 2, 0, 1, 3. Data band 2 is closest to the bottom edge of the tape.

A track group is a set of tracks that is recorded concurrently. The sets of 11 data tracks in a data band are data sub-bands. There are 16 data sub-bands per data band. The data tracks are accessed in a serpentine manner.

A wrap is a track group recorded in the physical forward or physical reverse direction. The wraps are recorded in a serpentine fashion starting in data band 0. The tape contains 44 track groups, 22 written in the forward direction and 22 written in the reverse direction. Even-numbered wraps are recorded in the forward direction (BOT to EOT), and odd-numbered wraps are recorded in the reverse direction (EOT to BOT).

[Figure 14](#) shows the layout of data on an LTO tape.

Figure 14 Layout of the Tracks on LTO Ultrium Tapes

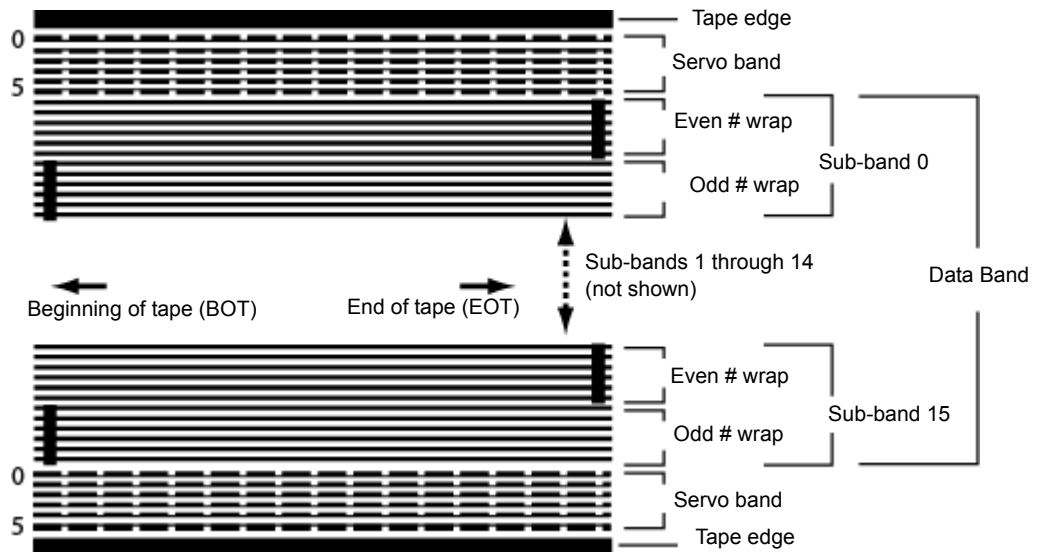

Recording Method

The LTO-3 (Model B) Half-Height Tape Drive records data using write-equalized (0,13/11) Run Length Limited (RLL) code. RLL (0,13/11) Data bits are defined as follows:

- **ONE** is represented by a flux transition at the center of a bit-cell.
- **ZERO** is represented by no flux transition in the bit-cell.

Data Buffer

In its default configuration, the LTO-3 (Model B) Half-Height Tape Drive has a 128-Mbyte buffer. The buffer controller has a burst transfer rate of 320 Mbytes/sec., and utilizes bank switching to achieve a maximum average bandwidth of nearly 240 Mbytes/sec. The high bandwidth is needed to support look-aside data compression in the case of compressible data being transferred from SCSI at 160 Mbytes/sec.

Data Integrity

The mechanical and electrical design of the drive ensures that drive performance does not degrade over time. Changes in head alignment, head wear, component drift, and other factors are minimized to ensure that data integrity and interchange capability are not compromised. The drive also incorporates adaptive Finite Impulse Response (FIR) filters that modify the equalization of each read channel dynamically to compensate for many of those changes.

The error rate of the LTO-3 (Model B) Half-Height Tape Drive is less than 1 hard error in 10^{17} bits. The undetectable error rate is 1 in 10^{27} bits read.

Error-correction Code (ECC)

The use of Cyclic Redundancy Checking (CRC), two-level orthogonal Error Correction Coding (ECC) provides a very low probability of encountering a hard error. During the read process, ECC correction is performed on the fly without affecting tape streaming.

There are two levels of Error Correction Coding (ECC). These two levels are orthogonal — that is, an ECC codeword at one level intersects ECC codewords at the other level just once, which means there will be only one common symbol between them. The two levels are called C1 and C2.

C1 ECC

As data is written to memory from the data processing unit, the DMA/ECC interface generates C1 ECC bytes and writes them to memory.

As data is written to tape, the C1 ECC is checked and an interrupt generated if there is an error. The C1 ECC read from memory is the ECC that is written to tape.

When data is read from tape and stored into memory, C1 ECC is checked and:

- If the C1 ECC is good, the “Valid” bit for the codeword pair is set.
- Otherwise, a pointer to the invalid codeword pair is passed to the C1 ECC correction engine.
 - If the C1 ECC correction engine can correct the error, then the corrected bytes are written to memory, and the Valid bit is set.
 - Otherwise, the Valid bit is left cleared.

As data is read from memory to the data processor for decompression, the C1 ECC is again checked and an interrupt generated if it is not correct.

C2 ECC

C2 ECC involves three distinct operations:

- 1 **Encoding:** Generating C2 ECC bytes from data bytes (performed by ECC coprocessor hardware).
- 2 **Decoding:** Generating ECC syndromes from data and ECC bytes, testing for all-zeroes (performed by ECC coprocessor hardware).

3 Correction: Generating corrected data from syndromes.

The correction depends on the number and types of errors involved:

- For one known C1 codeword pair in error in a subdata set (C2 codeword), the operation is performed by the ECC coprocessor hardware.
- For two or more known C1 codeword pairs in error, the matrix is computed by firmware and the correction is performed by hardware.
- For one or more unknown C1 codeword pairs, syndromes are generated by hardware, error location is computed by firmware, the matrix is computed by firmware and the correction is performed by hardware.

Servo-tracking Faults

During a write operation, if the servo system detects an error that may result in adjacent data tracks being overwritten, the write operation is aborted. The write operation will not continue until the correct servo tracking is re-established.

Data Compression

Typical data streams of text, graphics, software code, or other forms of data contain repeated information of some sort, whether it is at the text level where you can readily recognize regular repetitions of a single word, or at the binary level where the repetitions are in bits or bytes. Although most data is unique and random, the binary level data exhibits patterns of various sizes that repeat with varying degrees of regularity.

Storage efficiency is increased if the redundancies or repetition in the data are removed before the data is recorded to tape. Data compression technology significantly reduces or eliminates redundancies in data before recording the information to tape. This increases the amount of data that can be stored on a finite medium and increases the overall storage efficiency of the system.

With data compression, the redundant information in a data stream is identified and represented by codewords or symbols that allow the

same data to be recorded in a fewer number of bits. These codewords or symbols point back to the original data string, using fewer characters to represent the strings. Because these smaller symbols are substituted for the longer strings of data, more data can be stored in the same physical space.

Some important benefits result from data compression in tape drives:

- The same amount of information can be stored on a smaller length of tape.
- More data can be stored on a given length of tape.
- Performance can more closely parallel to that of high-transfer-rate computers.
- More information can be transferred in the same time interval.

Data Compression Considerations

In an effective data-compression method, several factors are important:

- The amount of compression, which is measured by the compression ratio. This ratio compares the amount of uncompressed data to the amount of compressed data. It is obtained by dividing the size of the uncompressed data by the size of the compressed data.
- The speed with which data is compressed and decompressed relative to the host transfer rate.
- The types of data to be compressed.
- The data integrity of the compressed data.

The amount of compression possible in a data stream depends on factors such as:

- Data pattern
- Compression algorithm
- Pattern repetition length
- Pattern repetition frequency
- Object size (block of information to be compressed)
- Starting pattern chosen

The transfer rate depends on factors such as:

- Compression ratio

- Drive buffer size
- Host computer input/output (I/O) speed
- Effective disc speeds of the host computer
- Record lengths that the host computer transmits

Data compression algorithms can be tailored to provide maximum compression for specific types of data. Because varying types of data are encountered in normal day-to-day operating circumstances, however, an effective data compression method for a tape drive must serve various data types. Additionally, the data compression method must adapt to different data types, automatically providing optimum handling for all types of data.

Intelligent Data Compression

The compressed capacity of the tape is maximized through the use of intelligent data compression. The intelligent data compression hardware determines the compressibility of each record. If the size of the record is larger after a compression attempt than the native (uncompressed) size, then the record is written in its native form.

The intelligent data compression utilizes two compression schemes:

- Scheme-1 is a LZ1-based compression scheme using a history buffer to achieve data compression.
- Scheme-2 is a pass-through compression scheme designed to pass uncompressible data through with minimal expansion.

There are three specific requirements for compliance with the LTO specification.

- The output data stream must be decompressible following LTO rules to create the input sequence of records and file marks perfectly.
- An LTO compressed data stream may not contain any of the eight reserved control symbols.
- While control symbols allow switching to Scheme 2, this should never be used by operational software because this capability is only for diagnostic and testing purposes.

Software data compression should never be used because the built-in intelligent data compression of the LTO-3 (Model B) Half-Height Tape Drive is much more efficient than software data compression.

The LTO-3 (Model B) Half-Height Tape Drive uses a derivative of ALDC-2 lossless data compression that includes additional control codes for intelligent data compression.

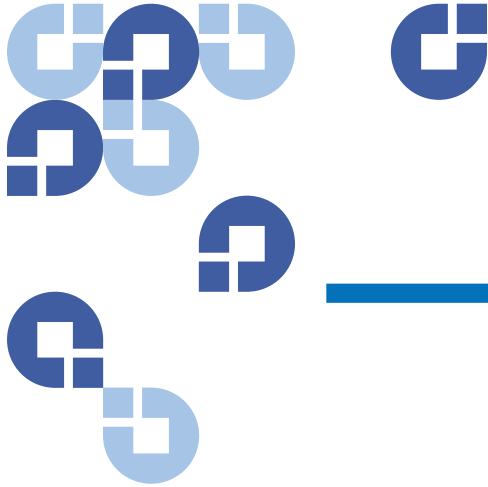

Chapter 5 Specifications

This chapter provides technical specifications for the LTO-3 (Model B) Half-Height Tape Drive.

The topics covered in this chapter are:

- [Physical Specifications](#)
- [Power Specifications](#) on page 45
- [Drive Performance Specifications](#) on page 46
- [Environmental Requirements](#) on page 48
- [Injected Noise Specifications](#) on page 49
- [Reliability Specifications](#) on page 49
- [LTO Cartridge Specifications](#) on page 50

Physical Specifications

[Table 3](#) lists the physical specifications of the LTO-3 (Model B) Half-Height Tape Drive, which is shown in [figure 15](#).

Table 3 Physical Specifications

Specification	Internal Drive		Tabletop Drive
	Without Bezel	With Bezel	
Height	1.63 inches (41.65 mm)	1.70 inches (42.87 mm)	2.60 inches 66.2 mm)
Width	5.75 inches (146.05)	5.87 inches (149.30 mm)	8.35 inches (212.13 mm)
Length	8.10 inches (205.98 mm) (Max. to end of connector)	8.31 inches (211.21 mm) (Max. to end of connector)	10.73 inches (272.49 mm)
Weight	3.66 lbs. (1.66 kg)	3.72 lbs. (1.69 kg)	8.00 lb. (3.63 kg)

Figure 15 LTO-3 (Model B)
Half-Height Tape Drive
Dimensions (front)

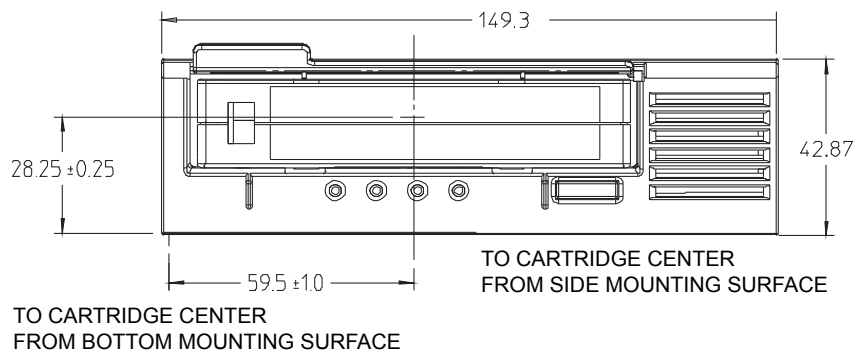
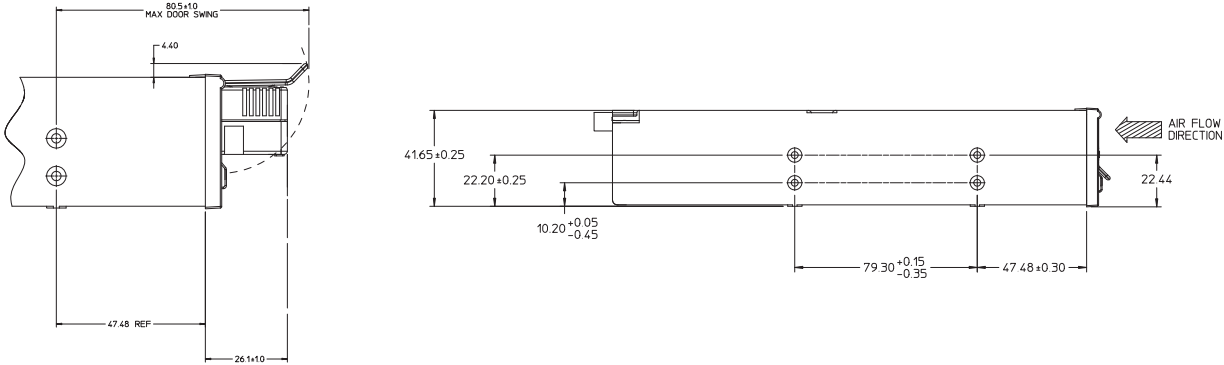

Figure 16 LTO-3 (Model B)
Half-Height Drive Dimensions
(side)



Power Specifications

The tabletop LTO-3 (Model B) Half-Height Tape Drive has a built-in 90-260 VAC (47-63 Hz) automatic switching power supply.

Maximum voltage and power specifications for the internal LTO-3 (Model B) Half-Height Tape Drive is listed in [table 4](#). Specifications are the same as those for other SCSI drives unless otherwise noted.

Table 4 Voltage and Current Specifications

Specification	+ 12 VDC	+ 5 VDC
DC Voltage Tolerance	12.00 ± 10%	5.00 ± 5%
Non-operating max voltage	13.2 Volts peak	5.25 Volts peak
Max operating current	2.73 amps	3.92 amps
Standby current (max)	0.28 amps	1.87 amps
Ripple (peak-to-peak)	≤ 100 mV	≤ 100 mV

Table 5 Power Dissipation

Power Specification	Dissipation
Max Standby Power	12.86 watts
Max Continuous Operating Power	31.35 watts
Max Peak Operating Power	36 watts (1 sec max)

Drive Performance Specifications

[Table 6](#) lists the performance specifications of the LTO-3 (Model B) Half-Height Tape Drive.

Table 6 Drive Performance Specifications

Specification	Value
Average data access time (650-m tape) from BOW (beginning of wrap)	70 seconds
Average rewind time (650-m tape)	67 seconds
Max rewind time (650-m tape)	135 seconds
Capacity LTO Ultrium 3 (680 m)	400 Gbytes (native)
Cartridge unload time	<19 seconds
Error recovery	Read-after-write Reed Solomon ECC (2 levels)
Flux density	10249 cells per mm

Specification	Value
Head configuration	2 bumps 16 thin-film write heads per bump 16 MR read heads per bump 2 MR servo heads per bump
Maximum data access time (650-m tape) from BOW	140 seconds
Maximum rewind time (650-m tape)	≤ 115 seconds
Recording density	5,120 RLL-encoded ONEs per mm
Recording format	Ultrium 16-channel (U-316)
Recording method	0, 13/11 RLL
Recording undetectable errors	Less than 1 in 10^{27} data bits
Recording unrecoverable errors	Less than 1 in 10^{17} data bits
Synchronous transfer rate (burst)	SCSI - 320 Mbytes per sec max (shared bandwidth) SAS - 300 Mbytes per sec max (dedicated bandwidth)
Tape drive type	LTO (Ultrium)
Tape speed	Up to 4.53 meters per second
Track density	70 tracks per mm
Transfer rate (sustained)	60 Mbytes/second (max, native)

Environmental Requirements

[Table 7](#) lists the environmental specifications of the LTO-3 (Model B) Half-Height Tape Drive.

Table 7 Environmental Requirements

Specification	Operational	Nonoperational
Acoustic level idling (A-wt sum)	52 dBA maximum 5.0 LwA Bels	—
Acoustic level operational (A-wt sum)	57 dBA maximum 5.5 LwA Bels	—
Airflow requirements	Internal: 5 CFM (front to back)	
Altitude	max 13,000 feet MSL (at 25°C)	50,000 feet (power off)
Humidity gradient	<30% per hour	30% per hour
Relative humidity	20% to 80% non-condensing	10% to 95% non-condensing
Shock (1/2 sine wave)	10 Gs peak, 11 msec	40 Gs peak, 11 msec
Temperature	+50° to +104°F (+10° to + 40°C)	–40° to +149°F (–40° to + 66°C)
Thermal gradient	10°C per hour	20°C per hour
Vibration (sweep test)	0.005 inches DA (5-43 Hz) 0.50 G peak (43–1000 Hz) sweep rate 5-1000Hz; 1.0 octave per minute	0.1 inches (5–15Hz) 1.0 G (15–500 Hz) 1.0 octave per minute

Injected Noise Specifications

The internal drive operates without degradation of error rates with 100 mV of noise injected between the chassis and 0 V at the power connector at any frequency between 45 Hz and 20 MHz.

Reliability Specifications

The LTO-3 (Model B) Half-Height Tape Drive is designed for maximum reliability and data integrity. [Table 8](#) lists the reliability specifications.

Table 8 Reliability Specifications

Specification	Description
Cartridge load/eject	50,000 cartridge load/eject cycles (no thread)
Error recovery and control	<ul style="list-style-type: none"> • Error correction code techniques (C1 and C2 ECC) • Read-after-write (RAW) • Error monitoring and reporting (error log) • Retry on
Mean time between failures (MTBF)	250,000 hours MTBF at 100% duty cycle: power applied and tape moving continuously (tabletop drive; 50,000 hours at full load and 25°C)
Mean time to replace (MTTR)	Less than 30 minutes
Nonrecoverable error rate	Less than 1 in 10^{17} bits

Mean Time Between Failures

The mean time between failures (MTBF) for the internal drive is specified at 250,000 hours minimum. This specification includes all power-on and operational time but excludes maintenance periods. Operational time is assumed to be 100% of the power-on time. Operational time is the time the tape is loaded.

The MTBF for the tabletop drive power supply is 50,000 hours with the unit operated at full load and 25°C.

Note: The MTBF rating does not represent any particular drive, but is derived from a large database of test samples. Actual rates may vary from unit to unit.

Mean Time to Replace

The mean time to replace (MTTR) is the average time required by a qualified service technician to diagnose a defective drive and to install a replacement drive. The MTTR for LTO products is less than 0.5 hour (30 minutes).

The Quantum LTO drives are field-replaceable units. If a problem occurs with a subassembly or component in the drive, you should replace the entire unit. Return the drive to the factory in its original packaging. Contact your distributor, dealer, your computer system company or your Quantum sales representative to arrange the return.

LTO Cartridge Specifications

Environmental Considerations

[Table 9](#) lists the basic environmental tolerances for LTO Ultrium cartridges.

Table 9 Environmental Tolerances

Specification	Value
Maximum localized temperature-permanent tape damage	Greater than 52°C
Operating temperature	10°C to 40°C
Relative humidity	10% to 80% storage, 20% to 80% operating
Wet bulb temperature	26° C max

If during storage and/or transportation a cartridge has been exposed to conditions outside the specified values, it must be conditioned before use in the operating environment. The conditioning shall be exposure to the operating environment for a time equal to, or greater than, the time away from the operating environment, up to a maximum of 24 hours. There shall be no deposit of moisture anywhere on or in the cartridge.

The stray magnetic field at any point on the tape shall not exceed 4000 A/m.

Cartridge Memory

Each Ultrium cartridge has 4 Kbytes of nonvolatile memory:

- 3 Kbytes are used to store tape-directory and hardware specific information.
- 1 Kbyte is available for application and OEM use.

The cartridge memory is powered, read, and written to via a radio-frequency link.

Cartridge Reliability

After 5,000 load/eject cycles, replace the cartridge to insure data integrity.

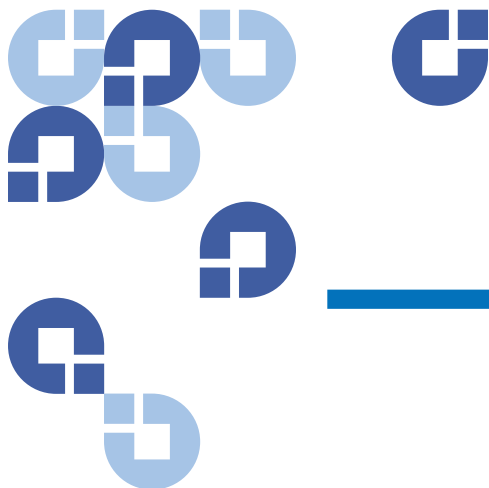

Chapter 6

Troubleshooting Guide

This chapter provides best-practice installation guidelines for getting the most out of your LTO-3 (Model B) Half-Height Tape Drive and troubleshooting information you can use to identify and resolve tape drive problems.

Topics covered in this chapter are:

- [Installation Best Practices](#)
- [Troubleshooting Suggestions](#) on page 55
- [Understanding LED Sequences](#) on page 67

Installation Best Practices

Following SCSI Best Practices

Always follow SCSI best practices when installing an LTO-3 (Model B) Half-Height Tape Drive to ensure trouble-free installation and operation.

Using a Parallel SCSI Host Bus Adapter (HBA)

To achieve the very best performance from your parallel SCSI LTO-3 (Model B) Half-Height Tape Drive and optimize your backup operations, always attach the drive to a SCSI controller that supports the Ultra160 SCSI LVD interface with 160 MBytes per sec. transfer rate. Attaching the drive to a non-LVD controller, or attaching non-LVD devices to the same bus with the LTO-3 (Model B) Half-Height Tape drive would degrade the performance of the drive and your backup operations.

Caution: Never connect the LTO-3 (Model B) Half-Height Tape Drive to a disk RAID controller. This is not supported.

If you must use a SCSI host bus adapter (HBA), always:

- Use a dedicated SCSI HBA to enable the best performance and reduce the chance of installation difficulties that might be caused by duplicate SCSI IDs on the same bus channel.
- Use a SCSI LVD controller kit that includes a high-quality SCSI cable and terminator that conforms to Ultra 2 SCSI specifications. A low-quality cable, or a cable that does not conform to the Ultra 2 SCSI specifications can cause intermittent write/read errors, SCSI timeouts, and corrupted data.
- Make sure that:
 - Your operating system supports both the adapter and your backup software application.
 - You have the proper drivers for the HBA, if any are necessary.

Using a Serial-attached SCSI Host Bus Adapter

To achieve the very best performance from your serial-attached SCSI (SAS) LTO-3 (Model B) Half-Height Tape Drive and optimize your backup operations, always attach the drive to a serial-attached SCSI controller that supports 3 GBytes per sec. per port transfer rate.

HBA Preinstallation Checks

Before installing the HBA, check and record your current system configuration. For example:

In the . . . operating system,	You can find information on any currently installed SCSI HBA by . . .
Windows 2000	<ol style="list-style-type: none"> 1 Double-clicking Administrative Tools in the Control Panel 2 Clicking Computer Management > Device Manager 3 Clicking the SCSI host adapters listed 4 Clicking Properties to view the Resources tab
UNIX/Linux	Viewing the boot log text file.

Refer to your operating system documentation for specific information on reviewing your system configuration.

After installing the SCSI HBA, restart the system. Then, ensure that the operating system recognizes the HBA and that there are no conflicts with other adapters.

Troubleshooting Suggestions

Computer Does Not Start

If the computer started and operated properly before installing a SCSI HBA and the LTO-3 (Model B) Half-Height Tape Drive, but does not start now:

- 1 Remove the SCSI HBA.

2 Restart the system.

IF the system . . .	THEN . . .
starts normally,	there is a problem with the SCSI HBA. 1 Make sure that the SCSI HBA: <ul style="list-style-type: none"> • Is compatible with system • Does not have burnt components Reinstall the SCSI HBA in a different PCI slot and restart the computer.
still does not start,	contact Technical Support.

Computer Hardware Does Not Recognize the Tape Drive

If the computer starts normally but does not recognize the tape drive:

- Restart the system and check whether the SCSI controller is recognized at system startup. You should see messages similar to:

SCSI Adapter Manufacturer SCSI BOIS xxxxxxx

CHA: SCSI ID #, SCSI Device Name

SCSI ID #, SCSI Device Name"

IF the SCSI controller is . . . during system startup,	THEN . . .
recognized	proceed to step 2 to determine whether the tape drive is recognized when the SCSI controller scans for devices.
not recognized	contact Technical Support.

- If the SCSI controller is recognized during system startup, restart the system to determine whether the tape drive is recognized when the SCSI controller scans for devices. You should see messages similar to:

Bus Target Lun Device

0 0 0 Quantum ULTRIUM 3

IF the tape drive is . . . during system startup,	THEN . . .
recognized	the problem has been resolved.
not recognized	Determine whether the tape drive is receiving power.

Computer Software Does Not Recognized the Tape Drive

Depending on your operating system environment, refer to the following subsections for troubleshooting guidelines if the LTO-Half-Height Tape drive is recognized by the system hardware at startup, but not by the operating system or applications.

Windows Operating System Environments

When a tape drive is installed in a Windows operating system environment, Windows displays a message on the screen if it does not have a driver in place for the tape drive.

IF the tape drive is for use in . . .	THEN you . . .
an ISV application,	can click the Cancel button to clear the message. When the ISV backup software application is running, the application invokes its own drivers to run the tape drive.
a native Windows operating system backup utility,	must install the proper driver for the tape drive.

Red Hat Linux Operating System Environments

The tape driver for Red Hat Linux, called **st**, is included as part of the Red Hat Linux operating system.

When Red Hat Linux starts, the operating system recognizes the tape drive and automatically configures it as a device in the **/dev** directory. If it is the first tape device in the **/dev** directory, the tape drive is known as:

/dev/st0 or /dev/nst0.

There are various ways to view the log files to see whether Linux recognizes the tape drive:

- One method is to open a terminal window and issue the following command from the root directory:

```
dmesg | grep SCSI
```

This command produces an output similar to:

```
(scsi0)<Adaptec AHA-294XX Ultra2 SCSI host adapter> found  
at PCI 0/16/0
```

- Another method might be to use the command:

```
cat /proc/scsi/scsi
```

This command produces an output similar to:

```
Host: scsi0 Channel: 0 Id:6 Lun:00  
Vendor: Quantum Model: ULTRIUM 3 Rev: 1897  
Type: Sequential-Access ANSI SCSI revision 04
```

- You can also use a text editor to view the messages in the file `/var/log/` and look for tape drive entries.
- Sometimes a system can have multiple tape device names in the `/dev` directory and will not know which `st` number to use. To view the `st` device number for your attached tape drive, use the command:

```
dmesg | grep tape
```

This command produces an output similar to:

```
Detected SCSI tape st0 and scsi0 . . .
```

Slow Backup Operations

Many factors can make backups appear to be slow. To achieve the highest possible transfer rate, the LTO-3 (Model B) Half-Height Tape Drive:

- MUST be attached to a Low Voltage Differential (LVD) SCSI controller capable of a minimum of 80 Mbytes per sec., and
- MUST NOT share the same SCSI bus as another active SCSI device such as hard drives.

1 Verify that the tape drive is attached to an LVD SCSI controller. You can do this by:

- Watching the system the startup process
- Examining the system startup log files

IF the tape drive is . . . to an LVD SCSI controller,	THEN . . .
attached	proceed to step 2 of this procedure to determine whether the tape drive shares the SCSI bus with another active SCSI device.
not attached	attach the tape drive to an LVD SCSI controller to achieve the best possible hardware performance for the best possible transfer rate.

2 If the tape drive is attached to an LVD SCSI controller, verify that it does not share the SCSI bus with another active SCSI device by:

- Checking:
 - Windows Device Manager
 - Unix/Linux logs
- Monitoring the SCSI controller activity during system startup.

IF the tape drive . . .	THEN . . .
shares the SCSI bus with other SCSI devices that are active when tape backups are performed,	reconfigure the SCSI setup to make the tape drive the only active device on the SCSI bus.
is the only active device on the SCSI bus	proceed to step 3 of this procedure to determine whether the method of performing tape backups is a factor.

- 3 The method of performing tape backups can be a factor in slow backup operations. Data sent to the tape drive over a network connection and delays in data transfer over a network connection can cause backups to slow down.

To determine whether the method of performing tape backups is a factor:

- a Use **StorageCare Sage xTalk** to perform a diagnostic write/read test.

Caution: The read/write test will overwrite any data on the tape. Always use a new/blank or “scratch” cartridge for diagnostic read/write tests.

The diagnostic write/read test evaluates the connection between the tape drive and the SCSI controller and removes the network data transfer and the backup software from the performance evaluation.

- b When the test finishes, determine the megabytes per second data transfer rate to verify that the tape drive is performing at an acceptable rate.

<p>IF you believe that the read/write transfer rate is . . .</p>	<p>THEN . . .</p>
<p>too slow,</p>	<p>use the StorageCare Sage xTalk to perform a trace buffer retrieval. Send the diagnostic output file to Technical Support for evaluation of the SCSI bus condition.</p>

<p>IF you believe that the read/write transfer rate is . . .</p>	<p>THEN . . .</p>
<p>acceptable, but backups still seem to be slow,</p>	<p>it might be attributed to the number of files and the average size of the backup files.</p> <p>These factors can have a significant effect on the backup performance.</p> <p>Backups where the average file size is less than 200 Kbytes, for example, are slower than backups where the average file size is greater than 200 Kbytes.</p> <p>Obtain backup log files to determine number of files and average file size.</p>

Failed Operations TapeAlert Messages

The LTO-3 (Model B) Half-Height Tape Drive supports the TapeAlert standard, and issues the appropriate alert messages in response to operational error conditions. You can view TapeAlert messages either directly, on the system screen, or in the log file of your backup application. Note, however, that some operational error conditions can cause more than one TapeAlert message.

The following subsections provide troubleshooting guidelines for dealing with the most common TapeAlert error conditions.

Backup Failure TapeAlert Messages

A number of problems can cause a backup operation to fail.

This TapeAlert message . . .	Signifies . . .
The operation has stopped because an error has occurred while reading or writing data which the drive cannot correct.	that a media error occurred during a read or write operation. Proceed to step 1 of the following procedure.
The tape is from a faulty batch or the tape drive is faulty. or: The tape is damaged or the drive is faulty. Call the tape drive supplier helpline.	that a media error occurred during a read or write operation. These messages frequently appear in addition to the "The operation has stopped because..." message. In this case, proceed to step 1 of the following procedure. Otherwise, repeat the backup operation with a known good tape and proceed to step 1 of the following procedure if the problem persists.

- 1 Review the configuration subsections in [chapter , Installation Procedures](#), on page 5 and verify that the SCSI bus is properly configured and terminated.
- 2 Retry the backup operation if you make any changes are made to the SCSI cabling or termination, or if you unplug and reconnect any SCSI cables.
- 3 If the problem persists, remove the data tape, insert a cleaning cartridge to clean the tape drive (see [Cleaning the Tape Drive](#) on page 33).
- 4 After the tape drive ejects the cleaning cartridge, reload the data tape and retry the backup operation.
- 5 If the problem persists, use **StorageCare Sage xTalk** to perform a write/read test with 4 Gbytes of data.

Caution: The write/read test will overwrite any data on the tape. Always use a new/blank or “scratch” cartridge for diagnostic write/read tests.

IF the diagnostic test . . .	THEN . . .
<p>completes normally,</p>	<p>retry the backup operation using the same new/blank or “scratch” tape that you used for the diagnostic write/read test.</p> <p>If the backup retry:</p> <ul style="list-style-type: none"> • Succeeds, discard the original data tape. The problem is resolved. • Fails, repeat steps 3 and 4 of this procedure to clean the tape drive a second time and proceed to step 6.
<p>fails,</p>	<p>repeat steps 3 and 4 of this procedure to clean the tape drive a second time and proceed to step 6.</p>

- 6 Retry the backup operation. If the backup retry:
- Succeeds, the problem is resolved.
 - Fails, contact Technical Support to resolve the possible problem with the tape drive.

Write-Protected TapeAlert Messages

Write-protected TapeAlert messages can appear in response to:

- Actual write-protected tape cartridges
- Defective tape cartridges

- Cartridges of a type that appear to be write protected

This TapeAlert message . . .	Signifies . . .
<p>You are trying to write to a write-protected cartridge. Remove the write-protection or use another tape.</p>	<p>that you are trying to write to a tape cartridge that is actually write protected.</p> <ol style="list-style-type: none"> 1 Eject the tape cartridge from the drive. 2 Set the cartridge write-protect switch to the unlocked (read-enabled) position (see figure 13 on page 31). 3 Retry the backup operation.
<p>The memory in the tape cartridge has failed, which reduces performance. Do not use the cartridge for further backup operations.</p> <p>and/or:</p> <p>You have loaded a cartridge of a type that is read-only in this drive. The cartridge will appear as write-protected.</p>	<p>you are trying to write to a tape cartridge that is either defective (failed Cartridge Memory chip), or the wrong type.</p> <p>Retry the backup operation using a known good cartridge of the proper type.</p> <p>If the problem persists, contact Technical Support to resolve the possible problem with the tape drive.</p>
<p>Overwrite protection is set to <i><setting></i>. Click OK to overwrite the media or insert new media that can be overwritten.</p>	<p>a software-related problem.</p> <p>Refer to the documentation for your backup software for information on the overwrite and append settings.</p>

Hardware Failure TapeAlert Messages

Hardware failure TapeAlert messages are descriptive and straightforward.

This TapeAlert message . . .	Signifies . . .
<p>The tape drive has a hardware fault:</p> <ol style="list-style-type: none"> 1. Eject the tape or magazine. 2. Reset the drive. 3. Restart the operation. <p>Or:</p> <p>The tape drive has a hardware fault:</p> <ol style="list-style-type: none"> 1. Turn the tape drive off and then on again. 2. Restart the operation. 3. If the problem persists, call the tape drive supplier helpline. 	<p>a tape drive hardware failure.</p>

- 1 Press the **Eject** button on the front panel to eject the tape cartridge.
- 2 Cycle the tape drive power to the off then on position:
 - For the internal LTO-3 (Model B) Half-Height Tape Drive:
 - a Terminate all running applications.
 - b Shut down the workstation or server system.
 - c Restart the system.
 - For the tabletop LTO-3 (Model B) Half-Height Tape Drive, use the AC power on/off switch on the back panel to cycle the drive power to the off then on positions.

Tape Cleaning TapeAlert Messages

Tape cleaning TapeAlert messages indicate problems when you insert a cleaning cartridge into the LTO-3 (Model B) Half-Height Tape Drive. Like

hardware failure TapeAlert messages, tape cleaning TapeAlert messages are descriptive and straightforward.

This TapeAlert message . . .	Signifies . . .
<p>The last cleaning cartridge used in the tape drive has worn out:</p> <ol style="list-style-type: none"> 1. Discard the worn out cleaning cartridge. 2. Wait for the current operation to finish. 3. Then use a new cleaning cartridge. 	<p>that the cleaning cartridge is used up. Discard it.</p> <p>See Cleaning the Tape Drive on page 33 and use a new or still functional LTO cleaning cartridge to clean the tape drive.</p>
<p>The last cleaning cartridge used in the tape drive was an invalid type:</p> <ol style="list-style-type: none"> 1. Do not use this cleaning cartridge in this drive. 2. Wait for the current operation to finish. 3. Then use a valid cleaning cartridge. 	<p>the tape drive does not recognize the cleaning tape as being of a valid type.</p> <p>See Cleaning the Tape Drive on page 33 and use a valid LTO-type cleaning cartridge to clean the tape drive.</p>
<p>The tape drive needs cleaning:</p> <ol style="list-style-type: none"> 1. If the operation has stopped, eject the tape and clean the drive. 2. If the operation has not stopped, wait for it to finish and then clean the drive. 3. Check the tape drive users manual for device specific cleaning instructions. 	<p>the tape drive has issued a message to the backup software to instruct you to clean the tape drive.</p> <p>See Cleaning the Tape Drive on page 33.</p>

Understanding LED Sequences

As shown in [figure 17](#), the LTO-3 (Model B) Half-Height Tape Drive front panel display has four LED indicators that reflect the operating condition of the drive:

The LEDs are either on steady or blinking at different rates in various combinations to indicate the various drive conditions as shown in [table 10](#).

Figure 17 Front Panel Display

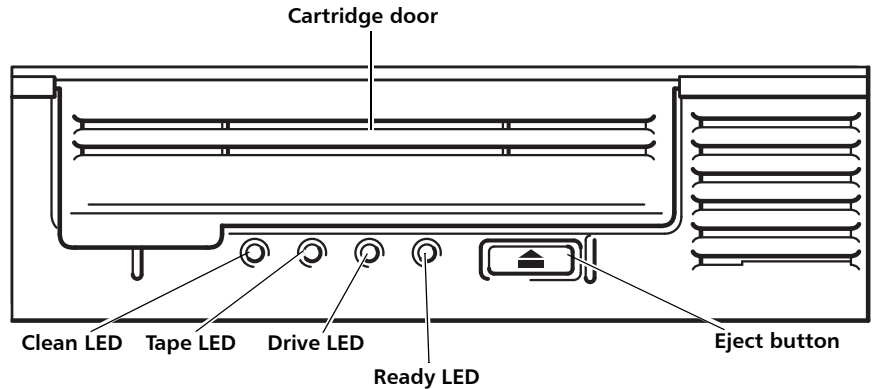

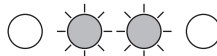







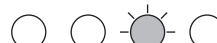

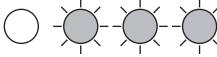
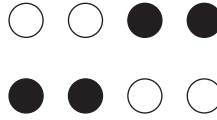
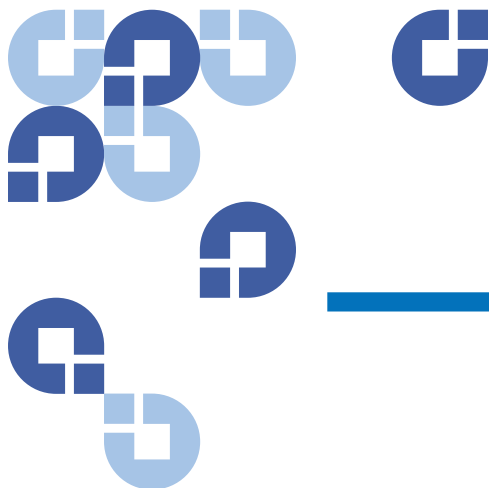

Table 10 Tape Drive LED Sequences

LED Sequence (Half-Height)	Cause	Action Required
 <p>All LEDs OFF</p>	<p>Drive may not have power, may be faulty or may have been power cycled or reset during a firmware upgrade.</p>	<p>Make sure the drive is switched on. The power on/off switch on an external drive incorporates a green LED.</p> <p>Check the power cord connection and replace the cable if necessary. On external drives, you can use the power cord from your monitor or another device to check that the connection is working.</p> <p>If the power supply is present and all LEDs remain off, power cycle or reset the drive. If it still fails, call for service.</p>
 <p>Ready and Clean OFF, Drive and Tape FLASH</p>	<p>The drive has failed to execute power-on self test (POST).</p>	<p>Power cycle or reset the drive.</p> <p>If the error condition reappears, call for service.</p>
 <p>Ready is ON.</p>	<p>The drive is ready for operation.</p>	<p>None. This is normal.</p>
 <p>Ready FLASHES.</p>	<p>The drive is carrying out a normal activity (read, write).</p>	<p>None.</p> <p>If the drive is upgrading firmware, do not reset or power cycle it.</p>
 <p>Ready FLASHES fast.</p>	<p>The drive is downloading firmware.</p>	<p>None.</p> <p>Do not reset or power cycle the drive.</p>

LED Sequence (Half-Height)	Cause	Action Required
 <p>Ready is OFF, others are ON</p>	<p>Firmware is being reprogrammed.</p>	<p>None. Do not reset or power cycle the drive.</p>
 <p>Clean FLASHES</p>	<p>The drive requires cleaning.</p>	<p>Load the Ultrium cleaning cartridge, see Cleaning the Tape Drive on page 33. If the Clean LED is still flashing when you load a new or known good data cartridge after cleaning, call for service.</p>
 <p>Ready FLASHES and Clean is ON</p>	<p>Cleaning is in progress.</p>	<p>None. The cleaning cartridge will eject on completion. The cleaning cycle can take up to 5 minutes to complete.</p>
 <p>Tape FLASHES</p>	<p>The drive believes the current tape or the tape just ejected is faulty.</p>	<p>Unload the tape cartridge. Make sure that you are using the correct format cartridge; an Ultrium data cartridge or Ultrium Universal Cleaning Cartridge. Reload the cartridge. If the Tape LED still flashes or starts flashing during the next backup, load a new or known good cartridge. If the Tape LED is now off, discard the 'suspect' tape cartridge. If it is still on, call for service.</p>
  <p>The tape is ejected immediately and Tape FLASHES, or Drive FLASHES on unloading tape.</p>	<p>The tape cartridge memory (CM) may be faulty.</p>	<p>Write protect the cartridge by sliding the switch on the tape cartridge, see Ultrium Tape Cartridge Write-Protect Switch on page 31. The tape can be loaded and the data read. Once the data is recovered, the cartridge must be discarded.</p>

LED Sequence (Half-Height)	Cause	Action Required
 <p>Drive FLASHES</p>	<p>The drive mechanism has detected an error.</p>	<p>Load a new cartridge. If the error persists, power cycle or reset the drive. If the Drive LED remains on, call for service.</p>
 <p>Drive, Tape, and Ready FLASH</p>	<p>There is a firmware download problem.</p>	<p>Insert a cartridge to clear the LED sequence. If the condition persists, call for service.</p>
 <p>Drive and Ready ON with Tape and Clean OFF. Alternates repeatedly.</p>	<p>The drive has a firmware error.</p>	<p>Power cycle or reset the drive. Upgrade the firmware. If the condition persists, call for service.</p>



Appendix A

Installation Checklists

Use the following quick-start checklists to get your tape drive up and running as quickly as possible:

- [Internal LTO-3 \(Model B\) Half-Height Tape Drive Quick Start](#)
- [Tabletop LTO-3 \(Model B\) Half-Height Tape Drive Quick Start](#)

Internal LTO-3 (Model B) Half-Height Tape Drive Quick Start

Use the following quick-start procedure to install the internal LTO-3 (Model B) Half-Height Tape Drive. Print this page and check each step as you complete it. If you need more information about a step, see the subsection referenced in the step.

q	1	Unpack the contents of your drive package, and check for damaged items. See Unpacking and Inspecting the Drive on page 8.
q	2	Review a parallel SCSI drive's default settings and change them if necessary: <ul style="list-style-type: none">• SCSI ID: 6• Terminator Power: Enabled See Configuring the Internal Parallel SCSI Tape Drive on page 9.

Appendix A
Internal LTO-3 (Model B) Half-Height Tape Drive Quick Start

q	3	Turn off your computer, remove its covers and power cable, and select a mounting bay for the drive. See Mounting the Internal Tape Drive on page 12.
q	4	Connect a parallel SCSI or serial-attached SCSI (SAS) interface cable to the drive. See Connecting the Internal Drive Interface and DC Power Cables on page 13.
q	5	Terminate the parallel SCSI bus if the internal tape drive is the last device on the SCSI bus. See figure 3 on page 11.
q	6	Connect a serial cable, if installing the tape drive in a tape library system. See Connecting the Internal Drive Interface and DC Power Cables on page 13.
q	7	Connect a DC power cable to the drive. See Connecting the Internal Drive Interface and DC Power Cables on page 13.
q	8	Replace the computer covers and AC power cable, turn on the computer, and verify that the internal tape drive is operating properly.
q	9	Register your tape drive. See Registering the LTO-3 (Model B) Half-Height Tape Drive on page 23.

Tabletop LTO-3 (Model B) Half-Height Tape Drive Quick Start

Use the following quick-start procedure to install tabletop LTO-3 (Model B) Half-Height Tape Drive. Print this page and check each step as you complete it. If you need more information about a step, see the subsection referenced in the step.

q	1	Unpack the contents of your drive package, and check for damaged items. See Unpacking and Inspecting the Drive on page 8.
q	2	Review the parallel SCSI drive's default settings and change them if necessary: <ul style="list-style-type: none"> • SCSI ID: 6 • Terminator Power: Enabled See Configuring the Tabletop Parallel SCSI Tape Drive on page 16.
q	3	Connect a parallel SCSI or serial-attached SCSI (SAS) interface cable to the drive. See Connecting the Internal Drive Interface and DC Power Cables on page 13.
q	4	Check SCSI bus termination for a parallel SCSI drive. See figure 8 on page 18.
q	5	Connect a power cable to the drive. See Connecting the Tabletop Drive Interface and AC Power Cables on page 18.
q	6	<ul style="list-style-type: none"> • Turn on the computer • Turn on the tabletop tape drive • Verify that the tabletop tape drive is operating properly.
q	7	Register your tape drive. Registering the LTO-3 (Model B) Half-Height Tape Drive on page 23.

Appendix A
Tabletop LTO-3 (Model B) Half-Height Tape Drive Quick Start

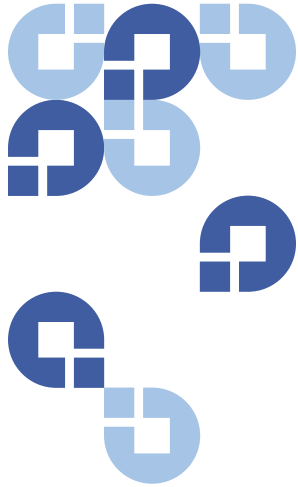

Appendix B

Disposal of Electrical & Electronic Equipment

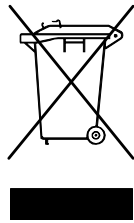

This symbol on the LTO-3 (Model B) Half-Height Tape Drive or on its packaging indicates that the tape drive should not be disposed of with your other waste materials. Instead, it should be submitted to a designated collection point for the recycling of electrical and electronic equipment. The separate collection and recycling of your waste equipment at the time of disposal helps conserve natural resources and ensures that the equipment is recycled in a manner that protects human health and the environment.

For more information about properly disposing of your waste equipment for recycling, please visit our website at qcare.quantum.com or contact your local government authority, your household waste disposal service, or the business from which you purchased the product.

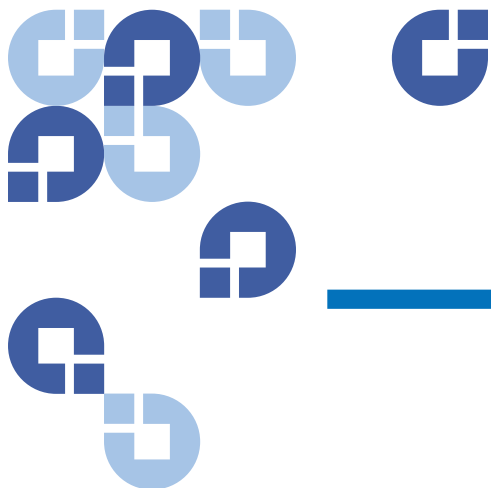

Appendix C

Regulatory Compliances

This appendix identifies the he LTO-3 (Model B) Half-Height Tape Drive regulatory compliances. The topics include:

- [Safety Compliances](#)
- [Electromagnetic Compatibility \(EMC\) Compliances](#) on page 78

Safety Compliances

The LTO-3 (Model B) Half-Height Tape Drives are safety compliant with the following regulatory codes in the countries indicated:

Country	Regulatory Organization	Compliant to:
Canada	Canadian Standards Association (CSA)	UL/CSA 60950-1
EU member nations	Comité Européen de Normalisation Electrotechnique – the European Committee for Electrotechnical Standardization (CENELEC)	EN 60950-1, 1st edition

Country	Regulatory Organization	Compliant to:
IECEE member nations*	International Electrotechnical Commission on Electrical Equipment (IECEE) for Mutual Recognition of Test Certificates for Electrical Equipment "CB Scheme"	CB Scheme per IEC 60950-1 with details and exceptions for each member country
Israel	SII	CB Scheme
Taiwan	BSMI	BSMI certification, CNS 14336
United States	Underwriters Laboratories (UL)	UL/CSA 60950-1

* IECEE member nations include: Argentina, Austria, Australia, Belgium, Brazil, Canada, China (PR), Czech Republic, Denmark, Finland, France, Germany, Hungary, India, Ireland, Israel, Italy, Japan, (South) Korea, Montenegro, Netherlands, Norway, Poland, Russian Federation, Serbia, Singapore, Slovakia, Slovenia, South Africa, Spain, Switzerland, Turkey, United Kingdom, and USA.

Electromagnetic Compatibility (EMC) Compliances

The LTO-3 (Model B) Half-Height Tape Drives are EMC compliant with the following regulatory organizations and codes in the countries indicated:

Country	Regulatory Organization	Compliant to:
Australia	Australian Communications and Media Authority (ACMA)	AS/NZS 3548 (same as CISPR 22)
Canada	Industry Canada Digital Apparatus - Interference-Causing Equipment Standard (ICES-003)	ICES-003 Digital Apparatus

Country	Regulatory Organization	Compliant to:
EU member nations	CE	Emissions per CISPR 22, EN55022 and Immunity per CISPR 24, EN55024
Israel	SII	CISPR 22 and CISPR 24
Japan	Voluntary Control Council for Interface (VCCI)	VCCI
New Zealand	Australian Communications and Media Authority (ACMA)	AS/NZS 3548 (same as CISPR 22)
South Korea	MIC	CISPR 22 and CISPR 24
Taiwan	Bureau of Commodity Inspection and Quarantine (BSMI)	BSMI EMC certification, CNS 14338
United States	Federal Communications Commission (FCC)	Title 47: Code of Federal Regulations, Part 15, Subpart B (47CFR15B),

Note: Use the LTO-3 (Model B) Half-Height Tape Drive only in equipment where the combination has been determined to be suitable by an appropriate certification organization (for example, Underwriters Laboratories Inc. or the Canadian Standards Association in North America).

Also consider the following safety points:

- Install the drive in an enclosure that limits the user's access to live parts, gives adequate system stability and provides the necessary grounding for the drive.
- Provide the correct voltages (+5 VDC and +12 VDC) based on the regulation applied—Extra Low Voltage (SEC) for UL and CSA, and Safety Extra Low Voltage for BSI and VDE (if applicable).

Appendix C
Electromagnetic Compatibility (EMC) Compliances

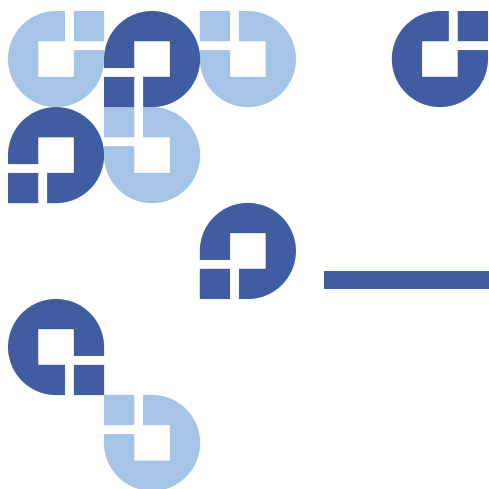

Index

B

backup/restore problems 61
best practices 53

C

cartridge memory, description 3
cartridges
 care and maintenance 32
 ejecting 30
 loading 30
 specifications 50
 unloading 30
 write-protecting 30
cautions, internal drives 6
chassis, description 3
configuring
 internal drives 9
 tabletop drives 16

D

data buffer 37

data buffering, description 3

data compression
 considerations 40
 description 3
 intelligent 41

data integrity 37
 error-correction code 38
 servo-tracking faults 39

data transfer rate
 description 3

drive performance specifications 46

E

ejecting a cartridge 30
environmental requirements 48
error-correction code 38

F

features 3
front panel display 25

G

guidelines, handling and
 installation 6

H

handling precautions 6
head positioner, description 3

I

injected noise 49
inspecting the drive 8
installation guidelines 7
installation instructions
 internal drives 8
 preinstallation requirements 7
 tabletop drives 16
installing the LTO driver 23
intelligent data compression 41
 description 3
interfaces, description 3

internal drives
 configuring 9
 guidelines and cautions 6
 installation instructions 8
 mounting 12
 parallel SCSI ID 10
 quick-start checklist 71
 registering 23
 terminator power 10

L

layout of track 35
 loading a cartridge 30
 LSI circuitry, description 3

M

mean time between failures 50
 method of recording 37
 mounting, internal drives 12

N

native data transfer rate,
 description 3

O

overview 1

P

physical specifications 43
 platforms, supported 3
 power specifications 45
 preinstallation requirements 7

Q

quick-start checklist
 internal drives 71
 tabletop drives 73

R

read channel, description 3
 recording method 37
 registering tape drive 23
 regulatory compliance 77
 reliability 49
 RISC processor, description 3

S

SCSI ID
 parallel internal drives 10
 parallel tabletop drives 16
 servo-tracking faults 39
 slow backups 58
 SmartVeirfy, description 3
 specifications
 drive performance 46
 environmental requirements
 48
 injected noise 49
 LTO cartridge 50
 mean time between failures 50
 physical 43
 power 45
 regulatory compliance 77
 reliability 49
 supported platforms 3

T

tabletop drives

configuring 16
 installation instructions 16
 parallel SCSI ID settings 16
 quick-start checklist 73
 tape drive
 registering 23
 tape picking, description 4
 TapeAlert
 description 3
 messages 65
 terminator power, internal drives
 10
 track layout 35
 troubleshooting 55
 backup/restore problems 61
 computer boots but does not
 recognize tape drive 56
 slow backups 58
 tape drive not recognized by
 operating system or
 application 57
 TapeAlert messages 65

U

unloading a cartridge 30
 unpacking the drive 8

W

write-protecting a cartridge 30