

Dell PowerEdge R430 Owner's Manual

Regulatory Model: E28S Series
Regulatory Type: E28S001



Notes, Cautions, and Warnings

 **NOTE:** A NOTE indicates important information that helps you make better use of your computer.

 **CAUTION:** A CAUTION indicates either potential damage to hardware or loss of data and tells you how to avoid the problem.

 **WARNING:** A WARNING indicates a potential for property damage, personal injury, or death.

Copyright © 2014 Dell Inc. All rights reserved. This product is protected by U.S. and international copyright and intellectual property laws. Dell™ and the Dell logo are trademarks of Dell Inc. in the United States and/or other jurisdictions. All other marks and names mentioned herein may be trademarks of their respective companies.

2014 - 12

Rev. A00

Contents

1 About your system.....	8
Front-panel features and indicators.....	8
LCD panel features.....	14
Home screen.....	15
Setup menu.....	15
View menu.....	15
Diagnostic indicators.....	16
Hard-drive indicator codes.....	17
Back-panel features and indicators.....	18
NIC indicator codes.....	20
Indicator codes for redundant power supply.....	20
Indicator codes for non-redundant power supply.....	22
Documentation matrix.....	23
Quick Resource Locator (QRL).....	23
2 Performing initial system configuration	25
Setting up your system.....	25
Setting up and configuring the iDRAC IP address	25
Logging in to iDRAC.....	25
Installing the operating system.....	26
Managing your system remotely.....	26
Downloading and installing drivers and firmware.....	26
3 Pre-operating system management applications.....	28
Navigation keys.....	28
About System Setup.....	28
Entering System Setup.....	29
System Setup Main Menu.....	29
System BIOS screen.....	29
System Information screen.....	30
Memory Settings screen.....	30
Processor Settings screen.....	31
SATA Settings screen.....	32
Boot Settings screen.....	35
Network Settings screen.....	35
Integrated Devices screen details.....	36
Serial Communication screen.....	37
System Profile Settings screen.....	38

System Security Settings screen.....	39
Miscellaneous Settings screen.....	41
About Boot Manager.....	42
Entering Boot Manager	42
Boot Manager main menu.....	42
About Dell Lifecycle Controller.....	42
Changing the boot order.....	43
Choosing the system boot mode.....	43
Assigning a system and setup password.....	43
Using your system password to secure your system.....	44
Deleting or changing an existing system and/or setup password.....	45
Operating with a setup password enabled.....	45
Embedded system management.....	45
iDRAC Settings utility.....	46
Entering the iDRAC Settings utility.....	46
Changing the Thermal Settings.....	46

4 Installing and removing system components..... 47

Safety instructions.....	47
Before working inside your system.....	47
After working inside your system.....	47
Recommended tools.....	48
Front bezel (optional).....	48
Installing the front bezel.....	48
Removing the front bezel.....	49
Removing and installing the system cover.....	49
Removing the system cover.....	49
Installing the system cover.....	50
Inside the system.....	51
Cooling shroud.....	53
Removing the cooling shroud.....	53
Installing the cooling shroud.....	54
System memory.....	54
General memory module installation guidelines.....	56
Mode-specific guidelines.....	56
Sample memory configurations.....	57
Removing memory module.....	59
Installing memory modules.....	60
Hard drives.....	62
Removing a 2.5 inch hard-drive blank.....	62
Installing a 2.5 inch hard-drive blank.....	63
Removing a 3.5 inch hard-drive blank.....	64

Installing a 3.5 inch hard-drive blank.....	65
Removing a cabled hard drive.....	65
Installing a cabled hard drive.....	66
Removing a hot-swap hard drive.....	67
Installing a hot-swap hard drive.....	68
Installing a 2.5 inch hard drive into a 3.5 inch hard-drive adapter.....	69
Removing a 2.5 inch hard drive from a 3.5 inch hard-drive adapter.....	70
Installing a hard-drive adapter into a hard-drive carrier.....	70
Removing a hard-drive adapter from a hard-drive carrier.....	71
Removing a hard drive from a hard-drive carrier.....	71
Installing a hard drive into a hard-drive carrier.....	72
Optical drive (optional).....	72
Removing an ultra slim optical drive.....	72
Installing an ultra slim optical drive.....	73
Removing the standard optical drive.....	74
Installing the standard optical drive.....	75
Cooling fans.....	76
Removing a cooling fan.....	76
Installing a cooling fan.....	77
Internal USB memory key (optional).....	78
Replacing the internal USB key.....	78
Expansion cards and expansion-card risers (optional).....	79
Expansion card installation guidelines.....	79
Removing the expansion-card riser.....	80
Installing the expansion-card riser.....	81
Removing an expansion card.....	82
Installing an expansion card.....	83
iDRAC ports card (optional).....	84
Removing the iDRAC port card.....	84
Installing the iDRAC port card.....	86
SD vFlash media card.....	86
Replacing an SD vFlash media card.....	86
Internal dual SD module.....	87
Removing an internal SD card.....	87
Installing an internal SD card.....	88
Removing the internal dual SD module.....	88
Installing the internal dual SD module.....	90
Integrated storage controller card.....	90
Removing the integrated storage controller card.....	90
Installing the integrated storage controller card.....	92
Heat sinks and processors.....	92
Removing a processor.....	93

Installing a processor.....	97
Power supplies.....	99
Hot Spare feature.....	99
Removing a redundant power supply.....	100
Installing a redundant power supply.....	101
Removing a non-redundant power supply.....	102
Installing a non-redundant power supply.....	103
Removing the power supply unit blank.....	104
Installing the power supply unit blank.....	104
System battery.....	104
Replacing the system battery.....	104
Hard-drive backplane.....	106
Removing the hard-drive backplane.....	106
Installing the hard-drive backplane.....	113
Control-panel assembly.....	113
Removing the control panel.....	113
Installing the control panel.....	116
Removing the control-panel module.....	117
Installing the control-panel module.....	120
Power interposer board.....	121
Removing the power interposer board.....	121
Installing the power interposer board.....	122
System board.....	123
Removing the system board.....	123
Installing the system board.....	125
Trusted Platform Module.....	127

5 Troubleshooting your system..... 129

Safety first—for you and your system.....	129
Troubleshooting system startup failure.....	129
Troubleshooting external connections.....	129
Troubleshooting the video subsystem.....	129
Troubleshooting a USB device.....	129
Troubleshooting a serial I/O device.....	130
Troubleshooting a NIC.....	130
Troubleshooting a wet system.....	131
Troubleshooting a damaged system.....	132
Troubleshooting the system battery.....	132
Troubleshooting power supply units.....	133
Power source problems.....	133
Power supply unit problems.....	133
Troubleshooting cooling problems.....	134

Troubleshooting cooling fans.....	134
Troubleshooting system memory.....	135
Troubleshooting an internal USB key.....	136
Troubleshooting an SD card.....	136
Troubleshooting an optical drive.....	137
Troubleshooting a tape backup unit.....	138
Troubleshooting a hard drive.....	138
Troubleshooting a storage controller.....	139
Troubleshooting expansion cards.....	140
Troubleshooting processors.....	140
System messages.....	141
Warning messages.....	141
Diagnostic messages.....	141
Alert messages.....	141
6 Using system diagnostics.....	142
Dell Embedded System Diagnostics.....	142
When to use the Embedded System Diagnostics.....	142
Running the Embedded System Diagnostics from Boot Manager.....	142
Running the Embedded System Diagnostics from the Dell Lifecycle Controller.....	142
System diagnostic controls.....	143
7 Jumpers and connectors.....	144
System board jumper settings.....	144
System board connectors.....	145
Disabling a forgotten password.....	147
8 Technical specifications.....	148
9 Getting help.....	154
Contacting Dell.....	154
Locating your system Service Tag.....	154
Documentation feedback.....	154
Quick Resource Locator (QRL).....	154

About your system

The Dell PowerEdge R430 is a rack server that supports up to two processors based on the Intel Xeon EP E5-2600 v3 family, up to 12 DIMMs, and up to ten hard drives/SSDs.

The R430 systems are available in the following configurations:

System	Configuration
Four hard-drive systems	Up to four 3.5 inch, cabled hard drives with non-redundant or redundant Power Supply Unit (PSU)
	Up to four 3.5 inch, hot-swappable hard drives with non-redundant or redundant PSU
Eight hard-drive systems	Up to eight 2.5 inch, hot-swappable hard drives/SSDs with redundant PSU
Ten hard-drive systems	Up to ten 2.5 inch, hot-swappable hard drives/SSDs with redundant PSU

Front-panel features and indicators

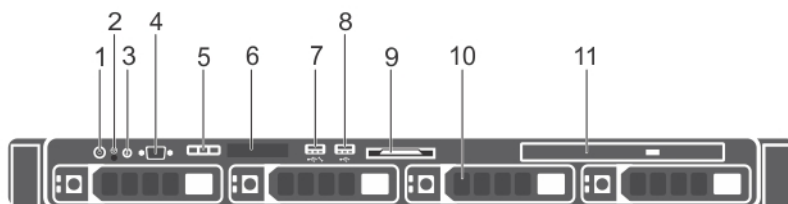









Figure 1. Front-panel features and indicators—four 3.5 inch hot-swappable hard-drive chassis

Item	Indicator, Button, or Connector	Icon	Description
1	Power-on indicator, power button		The power-on indicator lights when the system power is on. The power button controls the power supply output to the system.

Item	Indicator, Button, or Connector	Icon	Description
			 NOTE: On ACPI-compliant operating systems, turning off the system using the power button causes the system to perform a graceful shutdown before power to the system is turned off.
2	NMI button		<p>Used to troubleshoot software and device driver errors when running certain operating systems. This button can be pressed using the end of a paper clip.</p> <p>Use this button only if directed to do so by qualified support personnel or by the operating system's documentation.</p>
3	System identification button		<p>The identification buttons on the front and back panels can be used to locate a particular system within a rack. When one of these buttons is pressed, the LCD panel on the front and the system status indicator on the back flashes until one of the buttons is pressed again.</p> <p>Press to toggle the system ID on and off.</p> <p>If the system stops responding during POST, press and hold the system ID button for more than five seconds to enter BIOS progress mode.</p> <p>To reset iDRAC (if not disabled in F2 iDRAC setup) press and hold the button for more than 15 seconds.</p>
4	Video connector		Allows you to connect a display to the system.
5	LCD menu buttons		Allow you to navigate the control panel LCD menu.
6	LCD panel		<p>Displays system ID, status information, and system error messages. See LCD panel features.</p> <p> NOTE: LCD panel is not available in a cabled hard-drive chassis.</p>
7	USB management port/ iDRAC managed USB port		The USB management port can function as a regular USB port or provide access to the iDRAC features. For more information, see the iDRAC User's Guide at dell.com/esmanuals .
8	USB connector		Allows you to connect USB devices to the system. The port is USB 2.0-compliant.
9	Information tag		A slide-out label panel which contains system information such as Service Tag, NIC, MAC address, and so on for your reference.

Item	Indicator, Button, or Connector	Icon	Description
10	Hard drives		Up to four 3.5 inch hot-swappable hard drives/SSDs.
11	Optical drive (optional)		One optional slim SATA DVD-ROM drive or DVD +/-RW drive.

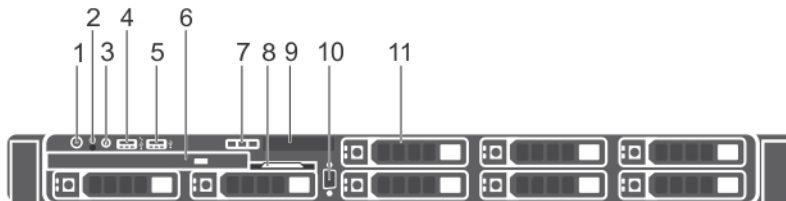





Figure 2. Front-panel features and indicators—eight 2.5 inch hot-swappable hard-drives/SSDs chassis

Item	Indicator, Button, or Connector	Icon	Description
1	Power-on indicator, power button		<p>The power-on indicator lights when the system power is on. The power button controls the power supply output to the system.</p> <p>NOTE: On ACPI-compliant operating systems, turning off the system using the power button causes the system to perform a graceful shutdown before power to the system is turned off.</p>
2	NMI button		<p>Used to troubleshoot software and device driver errors when running certain operating systems. This button can be pressed using the end of a paper clip.</p> <p>Use this button only if directed to do so by qualified support personnel or by the operating system's documentation.</p>
3	System identification button		<p>The identification buttons on the front and back panels can be used to locate a particular system within a rack. When one of these buttons is pressed, the LCD panel on the front and the system status indicator on the back flashes until one of the buttons is pressed again.</p> <p>Press to toggle the system ID on and off.</p>

Item	Indicator, Button, or Connector	Icon	Description
			If the system stops responding during POST, press and hold the system ID button for more than five seconds to enter BIOS progress mode.
			To reset iDRAC (if not disabled in F2 iDRAC setup) press and hold the button for more than 15 seconds.
4	USB management port/ iDRAC managed USB port		The USB management port can function as a regular USB port or provide access to the iDRAC features. For more information, see the iDRAC User's Guide at dell.com/esmmanuals .
5	USB connector		Allows you to connect USB devices to the system. The port is USB 2.0-compliant.
6	Optical drive (optional)		One optional slim SATA DVD-ROM drive or DVD +/-RW drive.
7	LCD menu buttons		Allow you to navigate the control panel LCD menu.
8	Information tag		A slide-out label panel which contains system information such as Service Tag, NIC, MAC address, and so on for your reference.
9	LCD panel		Displays system ID, status information, and system error messages. See LCD panel features .
10	Video connector		Allows you to connect a VGA display to the system.
11	Hard drives		Up to eight 2.5 inch hot-swappable hard drives/ SSDs.

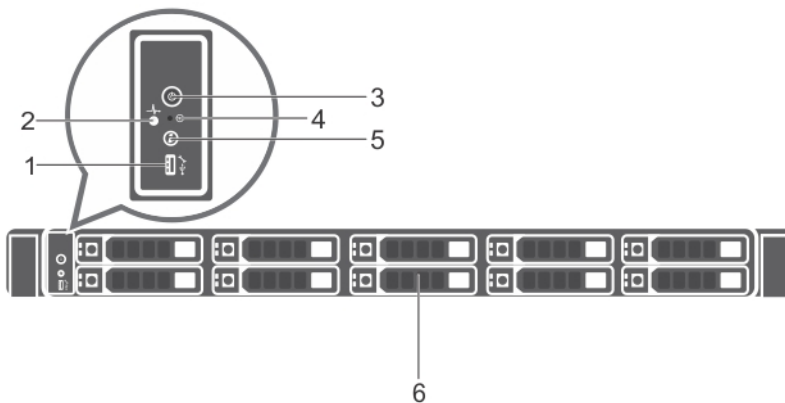







Figure 3. Front-panel features and indicators—ten 2.5 inch hot-swappable hard-drives/SSDs chassis

Item	Indicator, Button, or Connector	Icon	Description
1	USB management port/ iDRAC managed USB port		The USB management port can function as a regular USB port or provide access to the iDRAC features. For more information, see the iDRAC User's Guide at dell.com/esmmanuals .
2	Diagnostic indicator		The diagnostic indicator lights up to display error status. For more information, see Diagnostic indicators .
3	Power-on indicator, power button		The power-on indicator lights when the system power is on. The power button controls the power supply output to the system.  NOTE: On ACPI-compliant operating systems, turning off the system using the power button causes the system to perform a graceful shutdown before power to the system is turned off.
4	NMI button		Used to troubleshoot software and device driver errors when running certain operating systems. This button can be pressed using the end of a paper clip. Use this button only if directed to do so by qualified support personnel or by the operating system's documentation.
5	System identification button		The identification buttons on the front and back panels can be used to locate a particular system within a rack. When one of these buttons is pressed, the LCD panel on the front and the system status indicator on the back flashes until one of the buttons is pressed again. Press to toggle the system ID on and off. If the system stops responding during POST, press and hold the system ID button for more than five seconds to enter BIOS progress mode. To reset iDRAC (if not disabled in F2 iDRAC setup) press and hold the button for more than 15 seconds.
6	Hard drives		Up to ten 2.5 inch hot-swappable hard drives/ SSDs.

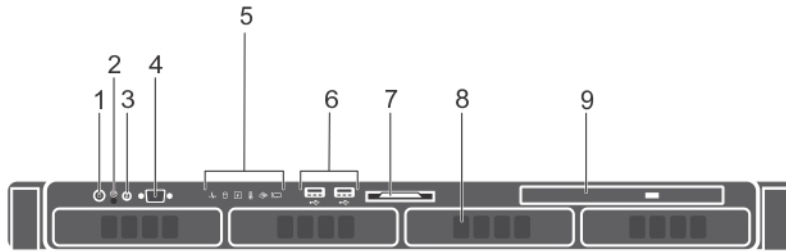



Figure 4. Front-panel features and indicators—four 3.5 inch cabled hard-drive chassis

Item	Indicator, Button, or Connector	Icon	Description
1	Power-on indicator, power button		<p>The power-on indicator lights when the system power is on. The power button controls the power supply output to the system.</p> <p> NOTE: On ACPI-compliant operating systems, turning off the system using the power button causes the system to perform a graceful shutdown before power to the system is turned off.</p>
2	NMI button		<p>Used to troubleshoot software and device driver errors when running certain operating systems. This button can be pressed using the end of a paper clip.</p> <p>Use this button only if directed to do so by qualified support personnel or by the operating system's documentation.</p>
3	System identification button		<p>The identification buttons on the front and back panels can be used to locate a particular system within a rack. When one of these buttons is pressed, the system status indicator on the back flashes until one of the buttons is pressed again. Press to toggle the system ID on and off. If the system stops responding during POST, press and hold the system ID button for more than five seconds to enter BIOS progress mode.</p> <p>To reset the iDRAC (if not disabled in F2 iDRAC setup) press and hold the button for more than 15 seconds.</p>
4	Video connector		Allows you to connect a display to the system.
5	Diagnostic indicators		The diagnostic indicator lights up to display error status. For more information, see Diagnostic indicators .

Item	Indicator, Button, or Connector	Icon	Description
6	USB connectors (2)		Allow you to connect USB devices to the system. The ports are USB 2.0-compliant.
7	Information tag		A slide-out label panel which contains system information such as Service Tag, NIC, MAC address, and so on for your reference.
8	Hard drives		Up to four 3.5 inch cabled hard drives.
9	Optical drive (optional)		One optional slim SATA DVD-ROM drive or DVD +/-RW drive.

LCD panel features

The system's LCD panel provides system information and status and error messages to indicate if the system is operating correctly or if the system needs attention. For more information on error messages, see the Dell Event and Error Messages Reference Guide at dell.com/esmmanuals.

- The LCD backlight lights blue during normal operating conditions.
- When the system needs attention, the LCD lights amber, and displays an error code followed by descriptive text.
 - ✎ **NOTE:** If the system is connected to a power source and an error is detected, the LCD lights amber regardless of whether the system is turned on or off.
- The LCD backlight turns OFF when the system is in standby mode and can be turned on by pressing either the Select, Left, or Right button on the LCD panel.
- The LCD backlight remains OFF if LCD messaging is turned off through the iDRAC utility, the LCD panel, or other tools.

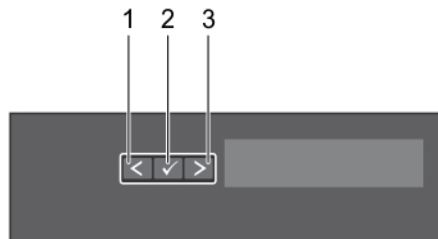

Figure 5. LCD panel features



Item	Button	Description
1	Left	Moves the cursor back in one-step increments.
2	Select	Selects the menu item highlighted by the cursor.
3	Right	Moves the cursor forward in one-step increments. During message scrolling: <ul style="list-style-type: none"> • Press once to increase scrolling speed • Press again to stop

Item	Button	Description
		<ul style="list-style-type: none"> • Press again to return to the default scrolling speed • Press again to repeat the cycle

Home screen

The Home screen displays user-configurable information about the system. This screen is displayed during normal system operation when there are no status messages or errors. When the system is in standby mode, the LCD backlight turns off after five minutes of inactivity if there are no error messages. Press one of the three navigation buttons (Select, Left, or Right) to view the Home screen.

To navigate to the Home screen from another menu, follow the steps below.

1. Press and hold the up arrow  until the **Home** icon  is displayed.
2. Select the **Home** icon.
3. From the Home screen, press the **Select** button to enter the main menu.

Setup menu

 **NOTE:** When you select an option in the Setup menu, you must confirm the option before proceeding to the next action.

Option	Description
iDRAC	Select DHCP or Static IP to configure the network mode. If Static IP is selected, the available fields are IP , Subnet (Sub) , and Gateway (Gtw) . Select Setup DNS to enable DNS and to view domain addresses. Two separate DNS entries are available.
Set error	Select SEL to display LCD error messages in a format that matches the IPMI description in the SEL. This is useful when trying to match an LCD message with an SEL entry. Select Simple to display LCD error messages in a simplified user-friendly description. For more information on error messages, see the Dell Event and Error Messages Reference Guide at dell.com/esmmanuals .
Set home	Select the default information to be displayed on the LCD Home screen. See View menu to see the options and option items that can be set as the default on the Home screen.

View menu

 **NOTE:** When you select an option in the View menu, you must confirm the option before proceeding to the next action.





Option	Description
iDRAC IP	Displays the IPv4 or IPv6 addresses for iDRAC8. Addresses include DNS (Primary and Secondary) , Gateway , IP , and Subnet (IPv6 does not have Subnet).
MAC	Displays the MAC addresses for iDRAC , iSCSI , or Network devices.



Option	Description
Name	Displays the name of the Host , Model , or User String for the system.
Number	Displays the Asset tag or the Service tag for the system.
Power	Displays the power output of the system in BTU/hr or Watts. The display format can be configured in the Set home submenu of the Setup menu.
Temperature	Displays the temperature of the system in Celsius or Fahrenheit. The display format can be configured in the Set home submenu of the Setup menu.

Diagnostic indicators

The diagnostic indicators on the system front panel display error status during system startup.

 **NOTE:** No diagnostic indicators are lit when the system is switched off. To start the system, plug it into a working power source and press the power button.

Icon	Description	Condition	Corrective action
	Health indicator	If the system is on, and in good health, the indicator lights solid blue. The indicator blinks amber if the system is on or in standby, and if any error exists (for example, a failed fan or hard drive).	None required. See the System Event Log or system messages for the specific issue. For more information on error messages, see the Dell Event and Error Messages Reference Guide at dell.com/esmmanuals . Invalid memory configurations can cause the system to halt at startup without any video output. See Getting help .
	Hard-drive indicator	The indicator blinks amber if a hard drive experiences an error.	See the System Event Log to determine the hard drive that has an error. Run the appropriate Online Diagnostics test. Restart system and run embedded diagnostics (ePSA). If the hard drives are configured in a RAID array, restart the system and enter the host adapter configuration utility program.
	Electrical indicator	The indicator blinks amber if the system experiences an electrical error (for example, voltage out of range, or a failed power supply or voltage regulator).	See the System Event Log or system messages for the specific issue. If it is due to a problem with the power supply, check the LED on the power supply. Re-seat the power supply by removing and reinstalling it. If the problem persists, see Getting help .
	Temperature indicator	The indicator blinks amber if the system experiences a thermal error (for example, a temperature out of range or fan failure).	Ensure that none of the following conditions exist: <ul style="list-style-type: none"> • A cooling fan is removed or has failed. • System cover, cooling shroud, EMI filler panel, memory-module blank, or back-filler bracket is removed.

Icon	Description	Condition	Corrective action
			<ul style="list-style-type: none"> Ambient temperature is too high. External airflow is obstructed. <p>See Getting help.</p>
	Memory indicator	The indicator blinks amber if a memory error occurs.	See the system event log or system messages for the location of the failed memory. Reinstall the memory device. If the problem persists, see Getting help .
	PCIe indicator	The indicator blinks amber if a PCIe card experiences an error.	Restart the system. Update any required drivers for the PCIe card. Re-install the card. If the problem persists, see Getting help .

Hard-drive indicator codes

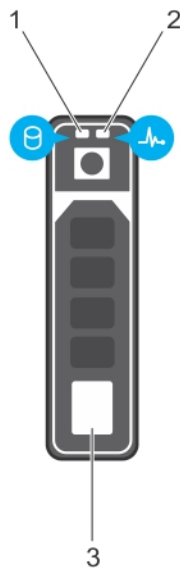



Figure 6. Hard-drive indicators

1. hard-drive activity indicator
2. hard-drive status indicator
3. hard drive

 **NOTE:** If the hard drive is in Advanced Host Controller Interface (AHCI) mode, the status indicator (on the right side) does not function and remains off.

Drive-status indicator pattern (RAID only)	Condition
Blinks green two times per second	Identifying drive or preparing for removal.
Off	Drive ready for insertion or removal.

Drive-status indicator pattern (RAID only)	Condition
	 NOTE: The drive status indicator remains off until all hard drives are initialized after the system is turned on. Drives are not ready for insertion or removal during this time.
Blinks green, amber, and turns off	Predicted drive failure
Blinks amber four times per second	Drive failed
Blinks green slowly	Drive rebuilding
Steady green	Drive online
Blinks green three seconds, amber three seconds, and turns off six seconds	Rebuild aborted

Back-panel features and indicators

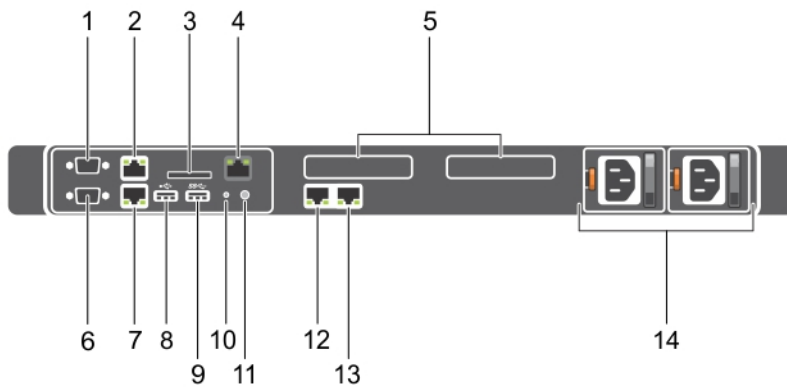



Figure 7. Back-panel features and indicators

Item	Indicator, Button, or Connector	Icon	Description
1	Serial connector		Allows you to connect a serial device to the system.
2	Ethernet connector 1		Integrated 10/100/1000 Mbps NIC connector.
3	vFlash card slot (optional)		Allows you to connect the vFlash card.
4	iDRAC port (optional)		Dedicated management port on the iDRAC ports card.
5	PCIe expansion card slots (2)		Allows you to connect a PCI Express expansion card.









Item	Indicator, Button, or Connector	Icon	Description
6	Video connector		Allows you to connect a VGA display to the system.
7	Ethernet connector 2		Integrated 10/100/1000 Mbps NIC connector.
8	USB connector		Allow you to connect USB devices to the system. The port is USB 2.0-compliant.
9	USB connector		Allow you to connect USB devices to the system. The port is USB 3.0-compliant.
10	System identification button		<p>The identification buttons on the front and back panels can be used to locate a particular system within a rack. When one of these buttons is pressed, the system status indicator on the back flashes until one of the buttons is pressed again. Press to toggle the system ID on and off. If the system stops responding during POST, press and hold the system ID button for more than five seconds to enter BIOS progress mode.</p> <p>To reset the iDRAC (if not disabled in F2 iDRAC setup) press and hold the button for more than 15 seconds.</p>
11	System identification connector		Connects the optional system status indicator assembly through the optional cable management arm.
12	Ethernet connector 3		Integrated 10/100/1000 Mbps NIC connector.
13	Ethernet connector 4		
14	Power supply (PSU1 and PSU2)		<p>Redundant power supply Up to two 550 W redundant AC power supplies.</p> <p>Non-redundant power supply One 450 W non-redundant AC power supply.</p> <p> NOTE: Non-redundant power supply is supported in systems with cabled hard drives and the systems with x4 backplane.</p> <p> NOTE: For non-redundant power supply units, there is only one power supply socket.</p>



Figure 9. AC power supply status indicator

1. AC power supply status indicator/handle

Convention	Power Indicator Pattern	Condition
A	Green	A valid power source is connected to the power supply and the power supply is operational.
B	Flashing green	When updating the firmware of the power supply unit is being updated, the power supply handle flashes green. ⚠ CAUTION: Do not disconnect the power cord or unplug the power supply unit when updating firmware. If firmware update is interrupted, the power supply units will not function. You must roll back the power supply firmware by using Life cycle controller. For more information, see Dell Lifecycle Controller User's Guide at dell.com/esmanuals.
C	Flashing green and turns off	When hot-adding a power supply, the power supply handle flashes green five times at 4 Hz rate and turns off. This indicates that there is a power supply mismatch with respect to efficiency, feature set, health status, and supported voltage. Replace the power supply with a power supply that matches the capacity of the other power supply. ✍ NOTE: For AC power supplies, use only PSUs with the Extended Power Performance (EPP) label on the back. Mixing PSUs from previous generations of Dell PowerEdge servers can result in a PSU mismatch condition or failure to power on.
D	Flashing amber	Indicates a problem with the power supply.

Convention	Power Indicator Pattern	Condition
		<p>⚠ CAUTION: When correcting a power supply mismatch, replace only the power supply with the flashing indicator. Swapping the other power supply to make a matched pair can result in an error condition and unexpected system shutdown. To change from a High Output configuration to a Low Output configuration or vice versa, you must power down the system.</p> <p>⚠ CAUTION: AC power supplies support both 220 V and 110 V input voltages with the exception of Titanium power supplies, which support only 220 V. When two identical power supplies receive different input voltages, they can output different wattages, and trigger a mismatch.</p> <p>⚠ CAUTION: If two power supplies are used, they must be of the same type and have the same maximum output power.</p> <p>⚠ CAUTION: Combining AC and DC power supplies is not supported and triggers a mismatch.</p>
E	Not lit	Power is not connected.

Indicator codes for non-redundant power supply

Press the self-diagnostic button to perform a quick health check on the non-redundant power supply of the system.

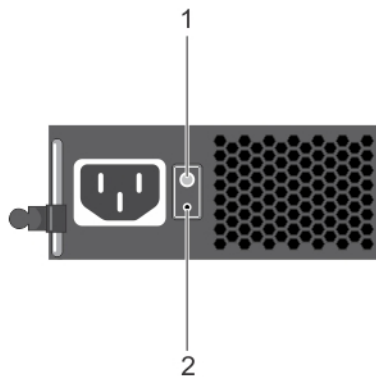

Figure 10. Non-redundant AC power supply status indicator and self-diagnostic button

1. self-diagnostic button
2. AC power supply status indicator

Power Indicator Pattern	Condition
Not lit	Power is not connected or power supply is faulty.
Green	A valid power source is connected to the power supply and the power supply is operational.

Documentation matrix

The documentation matrix provides information on documents that you can refer to for setting up and managing your system.

To...	Refer to...
Install your system into a rack	Rack documentation included with your rack solution
Set up your system and know the system technical specifications	<i>Getting Started With Your System</i> that shipped with your system or see dell.com/poweredgemanuals
Install the operating system	Operating system documentation at dell.com/operatingsystemmanuals
Get an overview of the Dell Systems Management offerings	Dell OpenManage Systems Management Overview Guide at dell.com/openmanagemanuals
Configure and log in to iDRAC, set up managed and management system, know the iDRAC features and troubleshoot using iDRAC	Integrated Dell Remote Access Controller User's Guide at dell.com/esmmanuals
Know about the RACADM subcommands and supported RACADM interfaces	RACADM Command Line Reference Guide for iDRAC and CMC at dell.com/esmmanuals
Launch, enable and disable Lifecycle Controller, know the features, use and troubleshoot Lifecycle Controller	Dell Lifecycle Controller User's Guide at dell.com/esmmanuals
Use Lifecycle Controller Remote Services	Dell Lifecycle Controller Remote Services Quick Start Guide at dell.com/esmmanuals
Set up, use, and troubleshoot OpenManage Server Administrator	Dell OpenManage Server Administrator User's Guide at dell.com/openmanagemanuals
Install, use and troubleshoot OpenManage Essentials	Dell OpenManage Essentials User's Guide at dell.com/openmanagemanuals
Know the features of the storage controller cards, deploy the cards, and manage the storage subsystem	Storage controller documentation at dell.com/storagecontrollermanuals
Check the event and error messages generated by the system firmware and agents that monitor system components	Dell Event and Error Messages Reference Guide at dell.com/esmmanuals

Quick Resource Locator (QRL)

Use the Quick Resource Locator (QRL) to get immediate access to system information and how-to videos. This can be done by visiting dell.com/QRL or by using your smartphone or tablet and a model specific Quick Resource (QR) code located on your Dell PowerEdge system. To try out the QR code, scan the following image.



Figure 11. Quick Resource Locator

Performing initial system configuration

After you receive your PowerEdge system, you must set up your system, install the operating system if it is not pre-installed, and set up and configure the system iDRAC IP address.

Setting up your system

1. Unpack the server.
2. Install the server into the rack. For more information on installing the server into the rack, see your system *Rack Installation Placemat* at dell.com/poweredgemanuals.
3. Connect the peripherals to the system.
4. Connect the system to its electrical outlet.
5. Turn the system on by pressing the power button or using iDRAC.
6. Turn on the attached peripherals.

Setting up and configuring the iDRAC IP address

You can set up the Integrated Dell Remote Access Controller (iDRAC) IP address by using one of the following interfaces:

- iDRAC Settings utility
- Lifecycle Controller
- Dell OpenManage Deployment Toolkit
- Server LCD panel

You can configure iDRAC IP address by using the following interfaces:

- iDRAC Web interface. For more information, see the Integrated Dell Remote Access Controller User's Guide.
- Remote Access Controller Admin (RACADM). For more information, see the RACADM Command Line Interface Reference Guide and the Integrated Dell Remote Access Controller User's Guide.
- Remote Services that includes Web Services Management (WS-Man). For more information, see the Lifecycle Controller Remote Services Quick Start Guide.

For more information on setting up and configuring iDRAC, see the Integrated Dell Remote Access Controller User's Guide at dell.com/esmmanuals.

Logging in to iDRAC

You can log in to iDRAC as an iDRAC local user, a Microsoft Active Directory user, or a Lightweight Directory Access Protocol (LDAP) user. You can also log in by using Single Sign-On or a Smart Card. The

default user name is **root** and password is **calvin**. For more information on logging in to iDRAC and iDRAC licenses, see the Integrated Dell Remote Access Controller User's Guide at dell.com/esmmanuals.

You can also access iDRAC using RACADM. For more information, see the RACADM Command Line Interface Reference Guide and the Integrated Dell Remote Access Controller User's Guide available at dell.com/esmmanuals.

Installing the operating system

If the server is shipped without an operating system, install the supported operating system on the server by using one of the following methods:

- Dell Systems Management Tools and Documentation media. See the operating system documentation at dell.com/operatingsystemmanuals.
- Dell Lifecycle Controller. See the Lifecycle Controller documentation at dell.com/esmmanuals.
- Dell OpenManage Deployment Toolkit. See the OpenManage documentation at dell.com/openmanagemanuals.

For information on the list of operating systems supported on your system, see the operating systems support matrix at dell.com/ossupport.

Managing your system remotely

To perform out-of-band systems management using iDRAC, you must configure iDRAC for remote accessibility, set up the management station and managed system, and configure the supported Web browsers. For more information, see the Integrated Dell Remote Access Controller User's Guide at dell.com/esmmanuals.

You can also remotely monitor and manage the server by using the Dell OpenManage Server Administrator (OMSA) software and OpenManage Essentials (OME) systems management console. For more information, see dell.com/openmanagemanuals.

Downloading and installing drivers and firmware

It is recommended that you download and install the latest BIOS, drivers, and systems management firmware on your system.

Prerequisites

Ensure that you clear the web browser cache.

Steps

1. Go to dell.com/support/drivers.
2. In the **Product Selection** section, enter the Service Tag of your system in the **Service Tag or Express Service Code** field.

 **NOTE:** If you do not have the Service Tag, select **Automatically detect my Service Tag for me** to allow the system to automatically detect your Service Tag, or select **Choose from a list of all Dell products** to select your product from the **Product Selection** page.

3. Click **Get drivers and downloads**.

The drivers that are applicable to your selection are displayed.

4. Download the drivers you require to a diskette drive, USB drive, CD, or DVD.

Pre-operating system management applications

The pre-operating system management applications for your PowerEdge system help you manage different settings and features of your system without booting to the operating system.

Your PowerEdge system has the following pre-operating system management applications:

- System Setup
- Boot Manager
- Dell Lifecycle Controller

Navigation keys

The navigation keys can help you access the pre-operating system management applications.

Key	Description
<Page Up>	Moves to the previous screen.
<Page Down>	Moves to the next screen.
Up arrow	Moves to the previous field.
Down arrow	Moves to the next field.
<Enter>	Enables you to type a value in the selected field (if applicable) or follow the link in the field.
Spacebar	Expands or collapses a drop-down list, if applicable.
<Tab>	Moves to the next focus area.
	 NOTE: This feature is applicable for the standard graphical browser only.
<Esc>	Moves to the previous page until you view the main screen. Pressing <Esc> in the main screen exits System BIOS/iDRAC Settings/Device Settings/Service Tag Settings and proceeds with system boot.
<F1>	Displays the System Setup help.

About System Setup

Using System Setup, you can configure the BIOS settings, iDRAC settings, and device settings of your system.

You can access System Setup in two ways:

- Standard Graphical Browser — This is enabled by default.
- Text Browser — This is enabled using Console Redirection.

 **NOTE:** By default, help text for the selected field is displayed in the graphical browser. To view the help text in the text browser, press <F1>.

Entering System Setup

1. Turn on or restart your system.
2. Press <F2> immediately after you see the following message:
<F2> = System Setup

If your operating system begins to load before you press <F2>, allow the system to finish booting, and then restart your system and try again.

System Setup Main Menu

Option	Description
System BIOS	Enables you to configure BIOS settings.
iDRAC Settings	Enables you to configure iDRAC settings. The iDRAC Settings utility is an interface to set up and configure the iDRAC parameters by using UEFI. You can enable or disable various iDRAC parameters by using the iDRAC Settings utility. For more information about this utility, see the Integrated Dell Remote Access Controller User's Guide at dell.com/esmmanuals .
Device Settings	Enables you to configure device settings.

System BIOS screen

By using the **System BIOS** screen you can view the BIOS settings as well as edit specific functions such as **Boot Order**, **System Password**, **Setup Password**, setting the RAID mode, and enabling or disabling USB ports.

In the **System Setup Main Menu**, click **System BIOS**.

Menu Item	Description
System Information	Displays information about the system such as the system model name, BIOS version and Service Tag.
Memory Settings	Displays information and options related to the installed memory.
Processor Settings	Displays information and options related to the processor such as speed, cache size, and so on.
SATA Settings	Displays options to enable or disable the integrated SATA controller and ports.
Boot Settings	Displays options to specify the boot mode (BIOS or UEFI). Enables you to modify UEFI and BIOS boot settings.
Network Settings	Displays options to change the network settings.
Integrated Devices	Displays options to enable or disable integrated device controllers and ports, and to specify related features and options.

Menu Item	Description
Serial Communication	Displays options to enable or disable the serial ports and specify related features and options.
System Profile Settings	Displays options to change the processor power management settings, memory frequency, and so on.
System Security	Displays options to configure the system security settings like, system password, setup password, TPM security, and so on. It also enables or disables support for the power and NMI buttons on the system.
Miscellaneous Settings	Displays options to change the system date, time, and so on.

System Information screen

You can use the **System Information** screen to view system properties such as Service Tag, system model, and the BIOS version.

To view the **System Information** click **System Setup Main Menu → System BIOS → System Information**.

Menu Item	Description
System Model Name	Displays the system model name.
System BIOS Version	Displays the BIOS version installed on the system.
System Management Engine Version	Displays the current revision of the Management Engine firmware.
System Service Tag	Displays the system Service Tag.
System Manufacturer	Displays the name of the system manufacturer.
System Manufacturer Contact Information	Displays the contact information of the system manufacturer.
System CPLD Version	Displays the current revision of the system CPLD firmware.
UEFI Compliance Version	Displays the system firmware UEFI compliance level.

Memory Settings screen

You can use the **Memory Settings** screen to view all the memory settings as well as enable or disable specific memory functions such as system memory testing and node interleaving.

To view the **Memory Setting** screen, click **System Setup Main Menu → System BIOS → Memory Settings**.

Menu Item	Description
System Memory Size	Displays the amount of memory installed in the system.
System Memory Type	Displays the type of memory installed in the system.
System Memory Speed	Displays the system memory speed.
System Memory Voltage	Displays the system memory voltage.
Video Memory	Displays the amount of video memory utilized.
System Memory Testing	Specifies whether system memory tests are run during system boot. Options are Enabled and Disabled . By default, the System Memory Testing option is set to Disabled .
Memory Operating Mode	Specifies the memory operating mode. The options available are Optimizer Mode , Advanced ECC Mode , Mirror Mode , Spare Mode , and



Menu Item	Description
	<p>Spare with Advanced ECC Mode. By default, the Memory Operating Mode option is set to Optimizer Mode.</p> <p> NOTE: The Memory Operating Mode can have different defaults and available options based on the memory configuration of your system.</p>
Node Interleaving	Specifies if Non-Uniform Memory architecture (NUMA) is supported. If this field is Enabled , memory interleaving is supported if a symmetric memory configuration is installed. If Disabled , the system supports NUMA (asymmetric) memory configurations. By default, Node Interleaving option is set to Disabled .
Snoop Mode	Specifies the Snoop Mode options. Snoop Mode options available are Home Snoop , Early Snoop , and Cluster on Die . By default, the Snoop Mode option is set to Early Snoop . The field is only available when Node Interleaving is Disabled .

Processor Settings screen

You can use the **Processor Settings** screen to view the processor settings and perform specific functions such as enabling virtualization technology, hardware prefetcher, and logical processor idling.

To view the **Processor Settings** screen, click **System Setup Main Menu** → **System BIOS** → **Processor Settings**.

Menu Item	Description
Logical Processor	Enables or disables the logical processors and displays the number of logical processors. If the Logical Processor option is set to Enabled , the BIOS displays all the logical processors. If this option is set to Disabled , the BIOS displays only one logical processor per core. By default, the Logical Processor option is set to Enabled .
Alternate RTID (Requestor Transaction ID) Setting	Enables you to allocate more RTIDs to the remote socket, thereby increasing cache performance between the sockets or easing work in normal mode for NUMA. By default, the Alternate RTID (Requestor Transaction ID) Setting is set to Disabled .
Virtualization Technology	Enables or disables the additional hardware capabilities provided for virtualization. By default, the Virtualization Technology option is set to Enabled .
Address Translation Service (ATS)	Defines the Address Translation Cache (ATC) for devices to cache the DMA transactions. This field provides an interface to a chipset's Address Translation and Protection Table to translate DMA addresses to host addresses. By default, the option is set to Enabled .
Adjacent Cache Line Prefetch	Optimizes the system for applications that require high utilization of sequential memory access. By default, the Adjacent Cache Line Prefetch option is set to Enabled . You can disable this option for applications that require high utilization of random memory access.
Hardware Prefetcher	Enables or disables the hardware prefetcher. By default, the Hardware Prefetcher option is set to Enabled .
DCU Streamer Prefetcher	Allows you to enable or disable the Data Cache Unit (DCU) streamer prefetcher. By default, the DCU Streamer Prefetcher option is set to Enabled .

Menu Item	Description
DCU IP Prefetcher	Enables or disables the Data Cache Unit (DCU) IP prefetcher. By default, the DCU IP Prefetcher option is set to Enabled .
Execute Disable	Enables or disables the execute disable memory protection technology. By default, the Execute Disable option is set to Enabled .
Logical Processor Idling	Enables or disables the operating system capability to put logical processors in the idling state in order to reduce power consumption. By default, the option is set to Disabled .
Configurable TDP	Allows reconfiguration of Thermal Design Power (TDP) to lower levels. TDP refers to the maximum amount of power the cooling system is required to dissipate.
X2Apic Mode	Enables or disables the X2Apic mode.
Number of Cores per Processor	Controls the number of enabled cores in each processor. By default, the Number of Cores per Processor option is set to All .
Processor 64-bit Support	Specifies if the processor(s) support 64-bit extensions.
Processor Core Speed	Displays the maximum core frequency of the processor.
Processor Bus Speed	Displays the bus speed of the processor.  NOTE: The processor bus speed option displays only when both processors are installed.
Processor 1	 NOTE: Depending on the number of installed CPUs, there may be up to two processor listings. The following settings are displayed for each processor installed in the system.
Family-Model-Stepping	Displays the family, model and stepping of the processor as defined by Intel.
Brand	Displays the brand name reported by the processor.
Level 2 Cache	Displays the total L2 cache.
Level 3 Cache	Displays the total L3 cache.
Number of Cores	Displays the number of cores per processor.

SATA Settings screen

You can use the **SATA Settings** screen to view the SATA settings of SATA devices and enable RAID on your system.

To view the **SATA Settings** screen click **System Setup Main Menu** → **System BIOS** → **SATA Settings**.

Menu Item	Description
Embedded SATA	Enables the embedded SATA to be set to Off , ATA , AHCI , or RAID modes. By default, the Embedded SATA option is set to AHCI .
Security Freeze Lock	Sends Security Freeze Lock command to the Embedded SATA drives during POST. This option is applicable only to ATA and AHCI mode.
Write Cache	Enables or disables the command for Embedded SATA drives during POST.

Menu Item	Description
Port A	Sets the drive type of the selected device. For Embedded SATA settings in ATA mode, set this field to Auto to enable BIOS support. Set it to OFF to turn off BIOS support. For AHCI mode or RAID mode, BIOS always enables support.
Model	Displays the drive model of the selected device.
Drive Type	Displays the type of drive attached to the SATA port.
Capacity	Displays the total capacity of the hard drive. The field is undefined for removable media devices such as optical drives.
Port B	Sets the drive type of the selected device. For Embedded SATA settings in ATA mode, set this field to Auto to enable BIOS support. Set it to OFF to turn off BIOS support. For AHCI mode or RAID mode, BIOS always enables support.
Model	Displays the drive model of the selected device.
Drive Type	Displays the type of drive attached to the SATA port.
Capacity	Displays the total capacity of the hard drive. The field is undefined for removable media devices such as optical drives.
Port C	Sets the drive type of the selected device. For Embedded SATA settings in ATA mode, set this field to Auto to enable BIOS support. Set it to OFF to turn off BIOS support. For AHCI mode or RAID mode, BIOS always enables support.
Model	Displays the drive model of the selected device.
Drive Type	Displays the type of drive attached to the SATA port.
Capacity	Displays the total capacity of the hard drive. The field is undefined for removable media devices such as optical drives.
Port D	Sets the drive type of the selected device. For Embedded SATA settings in ATA mode, set this field to Auto to enable BIOS support. Set it to OFF to turn off BIOS support. For AHCI mode or RAID mode, BIOS always enables support.
Model	Displays the drive model of the selected device.
Drive Type	Displays the type of drive attached to the SATA port.
Capacity	Displays the total capacity of the hard drive. The field is undefined for removable media devices such as optical drives.
Port E	Sets the drive type of the selected device. For Embedded SATA settings in ATA mode, set this field to Auto to enable BIOS support. Set it to OFF to turn off BIOS support. For AHCI mode or RAID mode, BIOS always enables support.
Model	Displays the drive model of the selected device.
Drive Type	Displays the type of drive attached to the SATA port.



Menu Item	Description
Capacity	Displays the total capacity of the hard drive. The field is undefined for removable media devices such as optical drives.
Port F	Sets the drive type of the selected device. For Embedded SATA settings in ATA mode, set this field to Auto to enable BIOS support. Set it to OFF to turn off BIOS support. For AHCI mode or RAID mode, BIOS always enables support.
Model	Displays the drive model of the selected device.
Drive Type	Displays the type of drive attached to the SATA port.
Capacity	Displays the total capacity of the hard drive. The field is undefined for removable media devices such as optical drives.
Port G	Sets the drive type of the selected device. For Embedded SATA settings in ATA mode, set this field to Auto to enable BIOS support. Set it to OFF to turn off BIOS support. For AHCI mode or RAID mode, BIOS always enables support.
Model	Displays the drive model of the selected device.
Drive Type	Displays the type of drive attached to the SATA port.
Capacity	Displays the total capacity of the hard drive. The field is undefined for removable media devices such as optical drives.
Port H	Sets the drive type of the selected device. For Embedded SATA settings in ATA mode, set this field to Auto to enable BIOS support. Set it to OFF to turn off BIOS support. For AHCI mode or RAID mode, BIOS always enables support.
Model	Displays the drive model of the selected device.
Drive Type	Displays the type of drive attached to the SATA port.
Capacity	Displays the total capacity of the hard drive. The field is undefined for removable media devices such as optical drives.
Port I	Sets the drive type of the selected device. For Embedded SATA settings in ATA mode, set this field to Auto to enable BIOS support. Set it to OFF to turn off BIOS support. For AHCI mode or RAID mode, BIOS always enables support.
Model	Displays the drive model of the selected device.
Drive Type	Displays the type of drive attached to the SATA port.
Capacity	Displays the total capacity of the hard drive. The field is undefined for removable media devices such as optical drives.
Port J	Sets the drive type of the selected device. For Embedded SATA settings in ATA mode, set this field to Auto to enable BIOS support. Set it to OFF to turn off BIOS support. For AHCI mode or RAID mode, BIOS always enables support.
Model	Displays the drive model of the selected device.

Menu Item	Description
Drive Type	Displays the type of drive attached to the SATA port.
Capacity	Displays the total capacity of the hard drive. The field is undefined for removable media devices such as optical drives.

Boot Settings screen

You can use the **Boot Settings** screen to set the Boot mode to either **BIOS** or **UEFI**. It also allows you to specify the boot order.

To view the **Boot Settings** screen click **System Setup Main Menu** → **System BIOS** → **Boot Settings**.

Menu Item	Description
Boot Mode	<p>Enables you to set the boot mode of the system.</p> <p> CAUTION: Switching the boot mode may prevent the system from booting if the operating system is not installed in the same boot mode.</p> <p> NOTE: Setting this field to UEFI disables the BIOS Boot Settings menu. Setting this field to BIOS disables the UEFI Boot Settings menu.</p> <p>If the operating system supports UEFI, you can set this option to UEFI. Setting this field to BIOS allows compatibility with non-UEFI operating systems. By default, the Boot Mode option is set to BIOS.</p>
Boot Sequence Retry	Enables or disables the Boot Sequence Retry feature. If this field is enabled and the system fails to boot, the system reattempts the boot sequence after 30 seconds. By default, the Boot Sequence Retry option is set to Enabled .
Hard-Disk Failover	Specifies which devices in the Hard-Disk Drive Sequence are attempted in the boot sequence. When the option is Disabled , only the first hard disk device in the list is attempted to boot. When set to Enabled , all hard disk devices are attempted in order, as listed in the Hard-Disk Drive Sequence . This option is not enabled for UEFI Boot Mode.
Boot Option Settings	Configures the boot sequence and the boot devices.

Network Settings screen

You can use the **Network Settings** screen to modify PXE device settings. Network Settings are only available in UEFI boot mode. BIOS does not control network settings in the BIOS boot mode. For BIOS boot mode, the network settings are handled by the network controllers option ROM.

To view the **Network Settings** click **System Setup Main Menu** → **System BIOS** → **Network Settings**.

Menu Item	Description
PXE Device n (n = 1 to 4)	Enables or disables the device. When enabled, a UEFI boot option is created for the device.
PXE Device n Settings (n = 1 to 4)	Allows you to control the configuration of the PXE device.

Integrated Devices screen details

The **Integrated Devices** screen allows you to view and configure the settings of all integrated devices including the video controller, integrated RAID controller, and the USB ports.

In the **System Setup Main Menu**, click **System BIOS** → **Integrated Devices**.



Menu Item	Description
USB 3.0 Setting	Allows you to enable or disable the USB 3.0 support. Enable this option only if your operating system supports USB 3.0. Disabling this allows devices to operate at USB 2.0 speed. USB 3.0 is disabled by default.
User Accessible USB Ports	Allows you to enable or disable the USB ports. Selecting Only Back Ports On disables the front USB ports and selecting All Ports Off disables all USB ports. The USB keyboard and mouse operates during boot process in certain operating systems. After the boot process is complete, the USB keyboard and mouse do not work if the ports are disabled.  NOTE: Selecting Only Back Ports On and All Ports Off will disable the USB management port and also restrict access to iDRAC features.
Internal USB Port	Allows you to enable or disable the internal USB port. By default, the Internal USB Port option is set to Enabled .
Integrated RAID Controller	Enables or disables the integrated RAID controller. By default, the option is set to Enabled .
Embedded NIC1 and NIC2	Allows you to enable or disable the Embedded NIC1 and NIC2. If set to Disabled , the NIC may still be available for shared network access by the embedded management controller. Configure this function using the NIC management utilities of the system.
Embedded NIC3 and NIC4	Allows you to enable or disable the Embedded NIC3 and NIC4. If set to Disabled , the NIC may still be available for shared network access by the embedded management controller. Configure this function using the NIC management utilities of the system.
I/OAT DMA Engine	Allows you to enable or disable the I/OAT option. Enable only if the hardware and software supports the feature.
Embedded Video Controller	Allows you to enable or disable the Embedded Video Controller . By default, the embedded video controller is Enabled . If the Embedded Video Controller is the only display capability in the system (that is, no add-in graphics card is installed), then the Embedded Video Controller is

	automatically used as the primary display even if the Embedded Video Controller setting is Disabled .
Current State of Embedded Video Controller	Displays the current state of the Embedded Video Controller. Current State of Embedded Video Controller is a read only field, indicating the current state for the Embedded Video Controller.
SR-IOV Global Enable	Allows you to enable or disable the BIOS configuration of Single Root I/O Virtualization (SR-IOV) devices. By default, the SR-IOV Global Enable option is set to Disabled .
OS Watchdog Timer	If your system stops responding, this watchdog timer aids in the recovery of your operating system. When this field is set to Enabled , the operating system is allowed to initialize the timer. When the field is set to Disabled (the default), the timer will have no effect on the system.
Memory Mapped I/O above 4 GB	Allows you to enable support for PCIe devices that require large amounts of memory. By default, the option is set to Enabled .
Slot Disablement	Allows you to enable or disable the available PCIe slots on your system. The Slot Disablement feature controls the configuration of PCIe cards installed in the specified slot. Slot disablement must be used only when the installed peripheral card is preventing booting into the operating system or causing delays in system startup. If the slot is disabled, both the Option ROM and UEFI driver are disabled.

Serial Communication screen

You can use the **Serial Communication** screen to view the properties of the serial communication port. To view the **Serial Communication** click **System Setup Main Menu** → **System BIOS** → **Serial Communication**.

Menu Item	Description
Serial Communication	Selects serial communication devices (Serial Device 1 and Serial Device 2) in the BIOS. BIOS console redirection can also be enabled and the port address can be specified. By default, Serial Communication option is set to Auto .
Serial Port Address	Enables you to set the port address for serial devices. By default, the Serial Port Address option is set to Serial Device 1=COM2, Serial Device 2=COM1
	 NOTE: You can use only Serial Device 2 for the Serial Over LAN (SOL) feature. To use console redirection by SOL, configure the same port address for console redirection and the serial device.



Menu Item	Description
	<p> NOTE: Every time the system boots, the BIOS syncs the serial MUX setting saved in iDRAC. The serial MUX setting can independently be changed in iDRAC. Therefore, loading the BIOS default settings from within the BIOS setup utility may not always revert this setting to the default setting of Serial Device 1.</p>
External Serial Connector	<p>You can associate the External Serial Connector to Serial Device 1, Serial Device 2, or the Remote Access Device using this field.</p> <p> NOTE: Only Serial Device 2 can be used for (Serial Over LAN) SOL. To use console redirection by SOL, configure the same port address for console redirection and the serial device.</p> <p> NOTE: Every time the system boots, the BIOS syncs the serial MUX setting saved in iDRAC. The serial MUX setting can independently be changed in iDRAC. Therefore, loading the BIOS default settings from within the BIOS setup utility may not always revert this setting to the default setting of Serial Device 1.</p>
Failsafe Baud Rate	<p>Displays the failsafe baud rate for console redirection. The BIOS attempts to determine the baud rate automatically. This failsafe baud rate is used only if the attempt fails, and the value must not be changed. By default, the Failsafe Baud Rate option is set to 115200.</p>
Remote Terminal Type	<p>Sets the remote console terminal type. By default, the Remote Terminal Type option is set to VT 100/VT 220.</p>
Redirection After Boot	<p>Enables or disables the BIOS console redirection when the operating system is loaded. By default, the Redirection After Boot option is set to Enabled.</p>

System Profile Settings screen

You can use the **System Profile Settings** screen to enable specific system performance settings such as power management.

To view the **System Profile Settings** click **System Setup Main Menu** → **System BIOS** → **System Profile Settings**.



Menu Item	Description
System Profile	<p>Sets the system profile. If you set the System Profile option to a mode other than Custom, the BIOS automatically sets the rest of the options. You can only change the rest of the options if the mode is set to Custom. By default, the System Profile option is set to Performance Per Watt Optimized (DAPC). DAPC is Dell Active Power Controller.</p> <p> NOTE: The following parameters are available only when the System Profile is set to Custom.</p>
CPU Power Management	<p>Sets the CPU power management. By default, the CPU Power Management option is set to System DBPM (DAPC). DBPM is Demand-Based Power Management.</p>
Memory Frequency	<p>Sets the speed of the system memory. You can select Maximum Performance, Maximum Reliability, or a specific speed.</p>
Turbo Boost	<p>Enables or disables the processor to operate in turbo boost mode. By default, the Turbo Boost option is set to Enabled.</p>

Menu Item	Description
Energy Efficient Turbo	Enables or disables the Energy Efficient Turbo . Energy Efficient Turbo (EET) is a mode of operation where a processor's core frequency is adjusted within the turbo range based on workload.
C1E	Enables or disables the processor to switch to a minimum performance state when it is idle. By default, the C1E option is set to Enabled .
C States	Enables or disables the processor to operate in all available power states. By default, the C States option is set to Enabled .
Collaborative CPU Performance Control	Enables or disables the CPU power management. When set to Enabled , the CPU power management is controlled by the OS DBPM and the System DBPM (DAPC). By default, the option is set to Disabled .
Memory Patrol Scrub	Sets the memory patrol scrub frequency. By default, the Memory Patrol Scrub option is set to Standard .
Memory Refresh Rate	Sets the memory refresh rate to either 1x or 2x. By default, the Memory Refresh Rate option is set to 1x .
Uncore Frequency	Selects the Processor Uncore Frequency . Dynamic mode allows the processor to optimize power resources across the cores and uncore during runtime. The optimization of the uncore frequency to either save power or optimize performance is influenced by the setting of the Energy Efficiency Policy .
Energy Efficient Policy	Enables you to select the Energy Efficient Policy . The CPU uses the setting to manipulate the internal behavior of the processor and determines whether to target higher performance or better power savings.
Number of Turbo Boost Enabled Cores for Processor 1	 NOTE: If there are two processors installed in the system, you see an entry for Number of Turbo Boost Enabled Cores for Processor 2 . Controls the number of turbo boost enabled cores for processor 1. By default, the maximum number of cores is enabled.
Monitor/Mwait	Enables the Monitor/Mwait instructions in the processor. By default, the Monitor/Mwait option is set to Enabled for all system profiles, except Custom .  NOTE: This option can be disabled only if the C States option in Custom mode is disabled.  NOTE: When C States is enabled in Custom mode, changing the Monitor/Mwait setting does not impact system power/performance.

System Security Settings screen

You can use the **System Security** screen to perform specific functions such as setting the system password, setup password and disabling the power button.

To view the **System Security** click **System Setup Main Menu** → **System BIOS** → **System Security Settings**.

Menu Item	Description
Intel AES-NI	Improves the speed of applications by performing encryption and decryption using the Advanced Encryption Standard Instruction Set and is set to Enabled by default.
System Password	Sets the system password. This option is set to Enabled by default and is read-only if the password jumper is not installed in the system.
Setup Password	Sets the setup password. This option is read-only if the password jumper is not installed in the system.
Password Status	Locks the system password. By default, the Password Status option is set to Unlocked .
TPM Security	<p> NOTE: The TPM menu is available only when the TPM module is installed.</p> <p>Allows you to control the reporting mode of the Trusted Platform Module (TPM). By default, the TPM Security option is set to Off. You can only modify the TPM Status, TPM Activation , and Intel TXT fields if the TPM Status field is set to either On with Pre-boot Measurements or On without Pre-boot Measurements.</p>
TPM Information	Changes the operational state of the TPM. By default, the TPM Activation option is set to No Change .
TPM Status	Displays the TPM status.
TPM Command	<p> CAUTION: Clearing the TPM results in the loss of all keys in the TPM. The loss of TPM keys may affect booting to the operating system.</p> <p>Clears all the contents of the TPM. By default, the TPM Clear option is set to No.</p>
Intel TXT	Enables or disables the Intel Trusted Execution Technology (TXT). To enable Intel TXT , Virtualization Technology must be enabled and TPM Security must be Enabled with Pre-boot measurements. By default, the Intel TXT option is set to Off
Power Button	Enables or disables the power button on the front of the system. By default, the Power Button option is set to Enabled .
NMI Button	Enables or disables the NMI button on the front of the system. By default, the NMI Button option is set to Disabled .
AC Power Recovery	Sets how the system reacts after AC power is restored to the system. By default, the AC Power Recovery option is set to Last .
AC Power Recovery Delay	Sets how the system supports staggering of power up after AC power is restored to the system. By default, the AC Power Recovery Delay option is set to Immediate .
User Defined Delay (60s to 240s)	Sets the User Defined Delay when the User Defined option for AC Power Recovery Delay is selected.
UEFI Variable Access	Provides varying degrees of securing UEFI variables. When set to Standard (the default) UEFI variables are accessible in the Operating System per the UEFI specification. When set to Controlled , selected UEFI variables are protected in the environment and new UEFI boot entries are forced to be at the end of the current boot order.

Menu Item	Description
Secure Boot	Enables Secure Boot, where the BIOS authenticates each pre-boot image using the certificates in the Secure Boot Policy. Secure Boot is disabled by default.
Secure Boot Policy	When Secure Boot policy is Standard , the BIOS uses the system manufacturer's key and certificates to authenticate pre-boot images. When Secure Boot policy is Custom , the BIOS uses the user-defined key and certificates. Secure Boot policy is Standard by default.
Secure Boot Policy Summary	Displays the list of certificates and hashes that secure boot uses to authenticate images.

Secure Boot Custom Policy Settings screen

Secure Boot Custom Policy Settings is displayed only when **Secure Boot Policy** is set to **Custom**. In the **System Setup Main Menu**, click **System BIOS** → **System Security** → **Secure Boot Custom Policy Settings**.

Menu Item	Description
Platform Key	Imports, exports, deletes, or restores the platform key (PK).
Key Exchange Key Database	Allows you to import, export, delete, or restore entries in the Key Exchange Key (KEK) Database.
Authorized Signature Database	Imports, exports, deletes, or restores entries in the Authorized Signature Database (db).
Forbidden Signature Database	Imports, exports, deletes, or restores entries in the Forbidden Signature Database (dbx).

Miscellaneous Settings screen

You can use the **Miscellaneous Settings** screen to perform specific functions such as updating the asset tag, and changing the system date and time.

To view the **Miscellaneous Settings** click **System Setup Main Menu** → **System BIOS** → **Miscellaneous Settings**.

Menu Item	Description
System Time	Enables you to set the time on the system.
System Date	Enables you to set the date on the system.
Asset Tag	Displays the asset tag and enables you to modify it for security and tracking purposes.
Keyboard NumLock	Enables you to set whether the system boots with the NumLock enabled or disabled. By default the Keyboard NumLock is set to On .  NOTE: This option does not apply to 84-key keyboards.
F1/F2 Prompt on Error	Enables or disables the F1/F2 prompt on error. By default, F1/F2 Prompt on Error is set to Enabled . The F1/F2 prompt also includes keyboard errors.
Load Legacy Video Option ROM	Enables you to determine whether the system BIOS loads the legacy video (INT 10H) option ROM from the video controller. Selecting Enabled

Menu Item	Description
	in the operating system does not support UEFI video output standards. This field is only for UEFI boot mode. You cannot set this to Enabled if UEFI Secure Boot mode is enabled.

About Boot Manager

Boot Manager enables you to add, delete, and arrange boot options. You can also access System Setup and boot options without restarting the system.

Entering Boot Manager

The **Boot Manager** screen allows you to select boot options and diagnostic utilities.

1. Turn on or restart your system.
2. Press <F11> when you see the message <F11> = Boot Manager.
If your operating system begins to load before you press <F11>, allow the system to finish booting, and then restart your system and try again.

Boot Manager main menu

Menu Item	Description
Continue Normal Boot	The system attempts to boot to devices starting with the first item in the boot order. If the boot attempt fails, the system continues with the next item in the boot order until the boot is successful or no more boot options are found.
One Shot Boot Menu	Takes you to the boot menu where you can select a one time boot device to boot from.
Launch System Setup	Enables you to access the System Setup.
Launch Lifecycle Controller	Exits the Boot Manager and invokes the Lifecycle Controller program.
System Utilities	Launches system utilities menu such as system diagnostics and UEFI shell.

About Dell Lifecycle Controller

Dell Lifecycle Controller allows you to perform useful tasks such as configuring BIOS and hardware settings, deploying an operating system, updating drivers, changing RAID settings, and saving hardware

profiles. For more information about Dell Lifecycle Controller, see the documentation at dell.com/esmmanuals.

Changing the boot order

You may have to change the boot order if you want to boot from a USB key or an optical drive. The instructions given below may vary if you have selected **BIOS** for **Boot Mode**.

1. In the **System Setup Main Menu**, click **System BIOS** → **Boot Settings**.
2. Click **Boot Option Settings** → **Boot Sequence**.
3. Use the arrow keys to select a boot device, and use the <+> and <-> keys to move the device down or up in the order.
4. Click **Exit**, click **Yes** to save the settings on exit.

Choosing the system boot mode

System Setup enables you to specify the boot mode for installing your operating system:

- BIOS boot mode (the default) is the standard BIOS-level boot interface.
- UEFI boot mode is an enhanced 64-bit boot interface based on Unified Extensible Firmware Interface (UEFI) specifications that overlays the system BIOS.

To choose the system **Boot Mode**:

1. In **System Setup** click **Boot Settings** and select **Boot Mode**.
2. Select the **Boot Mode** you want the system to boot into.

 **NOTE:** After the system boots in the specified boot mode, proceed to install your operating system from that mode.

 **CAUTION:** Trying to boot the operating system from the other boot mode will cause the system to halt at startup.

 **NOTE:** Operating systems must be UEFI-compatible to be installed from the UEFI boot mode. DOS and 32-bit operating systems do not support UEFI and can only be installed from the BIOS boot mode.

 **NOTE:** For the latest information on supported operating systems, go to dell.com/ossupport.

Assigning a system and setup password

Prerequisites

You can assign a new **System Password** and **Setup Password** or change an existing **System Password** and **Setup Password** only when the password jumper setting is **enabled** and **Password Status** is **Unlocked**.

If the password jumper setting is disabled, the existing **System Password** and **Setup Password** are deleted and you need not provide the system password to boot the system.

 **NOTE:** The password jumper enables or disables the System Password and Setup Password features. For more information about the password jumper settings, see [System board jumper settings](#).

Steps

1. To enter System Setup, press <F2> immediately after a power-on or reboot.
2. From the **System Setup Main Menu**, select **System BIOS** and press <Enter>. The **System BIOS** screen is displayed.
3. On the **System BIOS** screen, select **System Security** and press <Enter>. The **System Security** screen is displayed.
4. On the **System Security** screen, verify that **Password Status** is **Unlocked**.
5. Select **System Password**, enter your system password, and press <Enter> or <Tab>. Use the following guidelines to assign the system password:
 - A password can have up to 32 characters.
 - The password can contain the numbers 0 through 9.
 - Only the following special characters are allowed: space, ("), (+), (.), (-), (.), (/), (:), (|), (\), (|), (').A message prompts you to re-enter the system password.
6. Re-enter the system password, and click **OK**.
7. Select **Setup Password**, enter your setup password and press <Enter> or <Tab>. A message prompts you to re-enter the setup password.
8. Re-enter the setup password, and click **OK**.
9. Press <Esc> to return to the System BIOS screen. Press <Esc> again. A message prompts you to save the changes.

 **NOTE:** Password protection does not take effect until the system reboots.

Using your system password to secure your system

Prerequisites

 **NOTE:** If you have assigned a setup password, the system accepts your setup password as an alternate system password.

Steps

1. Turn on or reboot your system.
2. Type your password and press <Enter>.

Next steps

When **Password Status** is **Locked**, type the password and press <Enter> when prompted at reboot.

If an incorrect system password is entered, the system displays a message and prompts you to re-enter your password. You have three attempts to enter the correct password. After the third unsuccessful attempt, the system displays an error message that the system has halted and must be powered down.

Even after you shut down and restart the system, the error message is displayed until the correct password is entered.

 **NOTE:** You can use the **Password Status** option in conjunction with the **System Password** and **Setup Password** options to protect your system from unauthorized changes.

Deleting or changing an existing system and/or setup password

Prerequisites

Ensure that the Password jumper is set to enabled and the **Password Status** is set to **Unlocked** before attempting to delete or change the existing System and/or Setup password. You cannot delete or change an existing System or Setup password if the **Password Status** is **Locked**.

Steps

1. To enter System Setup, press **<F2>** immediately after a power-on or restart.
2. In the **System Setup Main Menu**, select **System BIOS** and press **<Enter>**.
The **System BIOS** screen is displayed.
3. In the **System BIOS Screen**, select **System Security** and press **<Enter>**.
The **System Security** screen is displayed.
4. In the **System Security** screen, verify that **Password Status** is set to **Unlocked**.
5. Select **System Password**, alter or delete the existing system password and press **<Enter>** or **<Tab>**.
6. Select **Setup Password**, alter or delete the existing setup password and press **<Enter>** or **<Tab>**.

 **NOTE:** If you change the System and/or Setup password, a message prompts you to re-enter the new password. If you delete the System and/or Setup password, a message prompts you to confirm the deletion.

7. Press **<Esc>** to return to the System BIOS screen. Press **<Esc>** again, and a message prompts you to save the changes.

Operating with a setup password enabled

If **Setup Password** is **Enabled**, enter the correct setup password before modifying most of the System Setup options.

If you do not enter the correct password in three attempts, the system displays the message

```
Invalid Password! Number of unsuccessful password attempts: <x> System Halted!  
Must power down.
```

Even after you shut down and restart the system, the error message is displayed until the correct password is entered. The following options are exceptions:

- If **System Password** is not **Enabled** and is not locked through the **Password Status** option, you can assign a system password.
- You cannot disable or change an existing system password.

 **NOTE:** You can use the Password Status option in conjunction with the **Setup Password** option to protect the system password from unauthorized changes.

Embedded system management

The Dell Lifecycle Controller provides advanced embedded systems management throughout the server's lifecycle. The Lifecycle Controller can be started during the boot sequence and can function independently of the operating system.

 **NOTE:** Certain platform configurations may not support the full set of features provided by the Lifecycle Controller.

For more information about setting up the Lifecycle Controller, configuring hardware and firmware, and deploying the operating system, see the Lifecycle Controller documentation at dell.com/support/home.

iDRAC Settings utility

The iDRAC Settings utility is an interface to set up and configure the iDRAC parameters using UEFI. You can enable or disable various iDRAC parameters using the iDRAC Settings Utility.

 **NOTE:** Accessing some of the features on the iDRAC Settings utility requires the iDRAC Enterprise License upgrade.

For more information on using iDRAC, see the iDRAC User's Guide at dell.com/esmmanuals.

Entering the iDRAC Settings utility

1. Turn on or restart the managed system.
2. Press <F2> during Power-on Self-test (POST).
3. In the System Setup Main Menu page, click **iDRAC Settings**.
The iDRAC Settings screen is displayed.

Changing the Thermal Settings

The iDRAC Settings utility enables you to select and customize the thermal control settings for your system.







1. Enter the iDRAC Settings utility.
2. Under **iDRAC Settings** → **Thermal** → **User Option**, select between the following options:
 - Default
 - Maximum Exhaust Temperature
 - Fan Speed Offset

 **NOTE:** When the **User Option** is set to the default **Auto** setting, the user option cannot be modified.

3. Set the **Maximum Air Exhaust Temperature** or the **Fan Speed Offset** fields.
4. Click **Back** → **Finish** → **Yes**.

Installing and removing system components

Safety instructions

-  **WARNING:** Whenever you need to lift the system, get others to assist you. To avoid injury, do not attempt to lift the system by yourself.
-  **WARNING:** Opening or removing the system cover while the system is powered on may expose you to a risk of electric shock.
-  **CAUTION:** Do not operate the system without the cover for a duration exceeding five minutes.
-  **CAUTION:** Many repairs may only be done by a certified service technician. You should only perform troubleshooting and simple repairs as authorized in your product documentation, or as directed by the online or telephone service and support team. Damage due to servicing that is not authorized by Dell is not covered by your warranty. Read and follow the safety instructions that came with the product.
-  **NOTE:** It is recommended that you always use a static mat and static strap while working on components inside the system.
-  **NOTE:** To ensure proper operation and cooling, all bays in the system must be populated at all times with either a module or with a blank.

Before working inside your system

1. Turn off the system, including any attached peripherals.
2. Disconnect the system from the electrical outlet and disconnect the peripherals.
3. If installed, remove the front bezel.
4. Remove the system cover.

Related Links

- [Removing the front bezel](#)
- [Removing the system cover](#)

After working inside your system

1. Install the system cover.
2. If applicable, install the front bezel.
3. Reconnect the system to its electrical outlet.
4. Turn the system on, including any attached peripherals.

Related Links

[Installing the front bezel](#)

[Installing the system cover](#)

Recommended tools

You may need the following items to perform the procedures in this section:

- Key to the system keylock
- #1 and #2 Phillips screwdriver
- Wrist grounding strap connected to ground

Front bezel (optional)

Installing the front bezel

1. Hook the right end of the bezel onto the chassis.
2. Fit the free end of the bezel onto the system.
3. Lock the bezel.

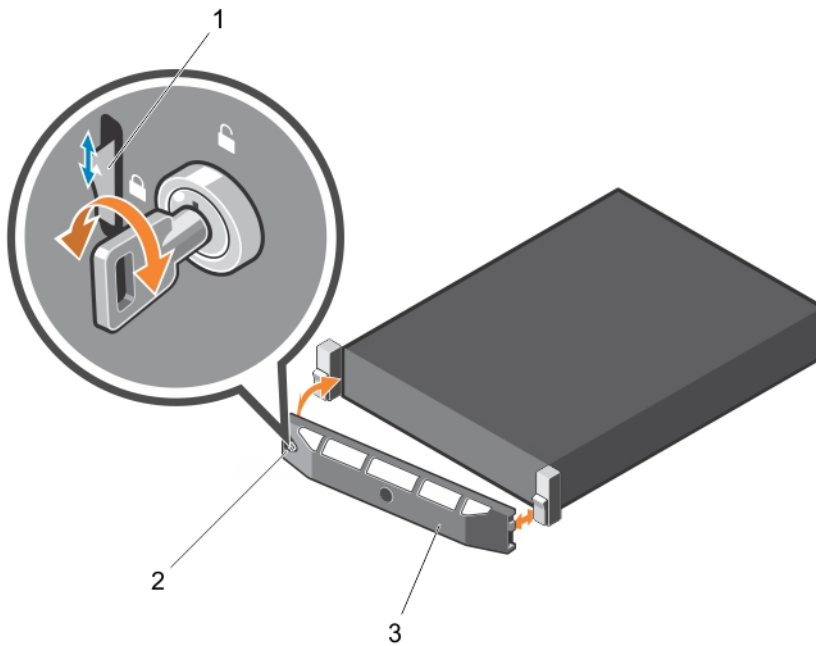

Figure 12. Removing and installing the front bezel

1. release latch
3. front bezel

2. keylock

Removing the front bezel

1. Unlock the keylock at the left end of the bezel.
2. Lift the release latch next to the keylock.
3. Rotate the left end of the bezel away from the front panel.
4. Unhook the right end of the bezel and pull the bezel away from the system.

Removing and installing the system cover

 **WARNING:** Whenever you need to lift the system, get others to assist you. To avoid injury, do not attempt to lift the system by yourself.

 **WARNING:** Installing or removing the system cover when the system is on may expose you to a risk of electric shock.

 **CAUTION:** Many repairs may only be done by a certified service technician. You should only perform troubleshooting and simple repairs as authorized in your product documentation, or as directed by the online or telephone service and support team. Damage due to servicing that is not authorized by Dell is not covered by your warranty. Read and follow the safety instructions that came with the product.

 **CAUTION:** Do not operate the system without the cover for a duration exceeding five minutes.

Removing the system cover

Prerequisites

1. Ensure that you read the [Safety instructions](#).
2. Turn off the system, including any attached peripherals.
3. Disconnect the system from the electrical outlet and peripherals.
4. If installed, remove the front bezel.

Steps

1. Turn the latch release lock to the unlock position.
2. Lift the latch and rotate the latch toward the back of the system.
The system cover slides back disengaging the tabs on the system cover from the slots on the chassis.
3. Hold the cover on both sides, and lift the cover away from the system.

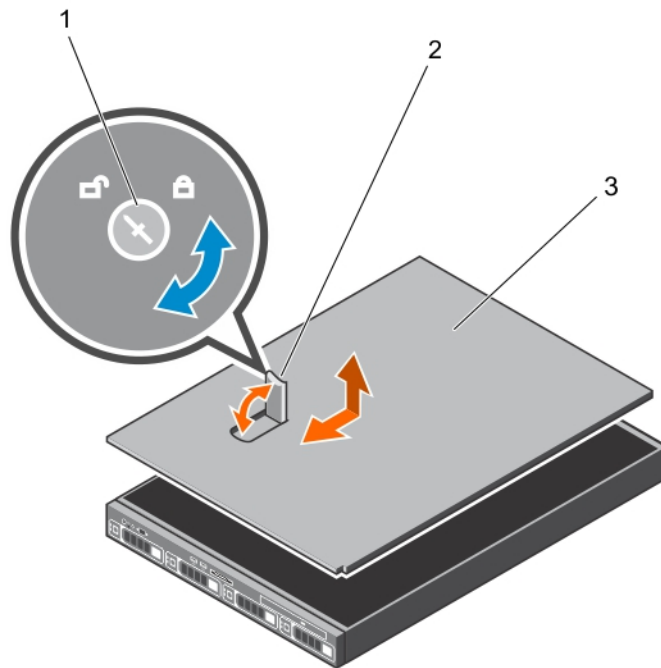

Figure 13. Removing and installing the system cover

1. latch release lock
2. latch
3. system cover

Related Links

[Removing the front bezel](#)

Installing the system cover

Prerequisites

Ensure that you read the [Safety instructions](#).

Steps

1. Align the slots of the system cover with the tabs on the chassis.
2. Press the cover release latch, and push the cover toward the front of the chassis until the latch locks into place.
3. Turn the cover latch release lock clockwise to the locked position.

Next steps

1. Install the bezel (optional).
2. Follow the procedure listed in [After working inside your system](#).

Related Links

[Installing the front bezel](#)

Inside the system

CAUTION: Many repairs may only be done by a certified service technician. You should only perform troubleshooting and simple repairs as authorized in your product documentation, or as directed by the online or telephone service and support team. Damage due to servicing that is not authorized by Dell is not covered by your warranty. Read and follow the safety instructions that came with the product.

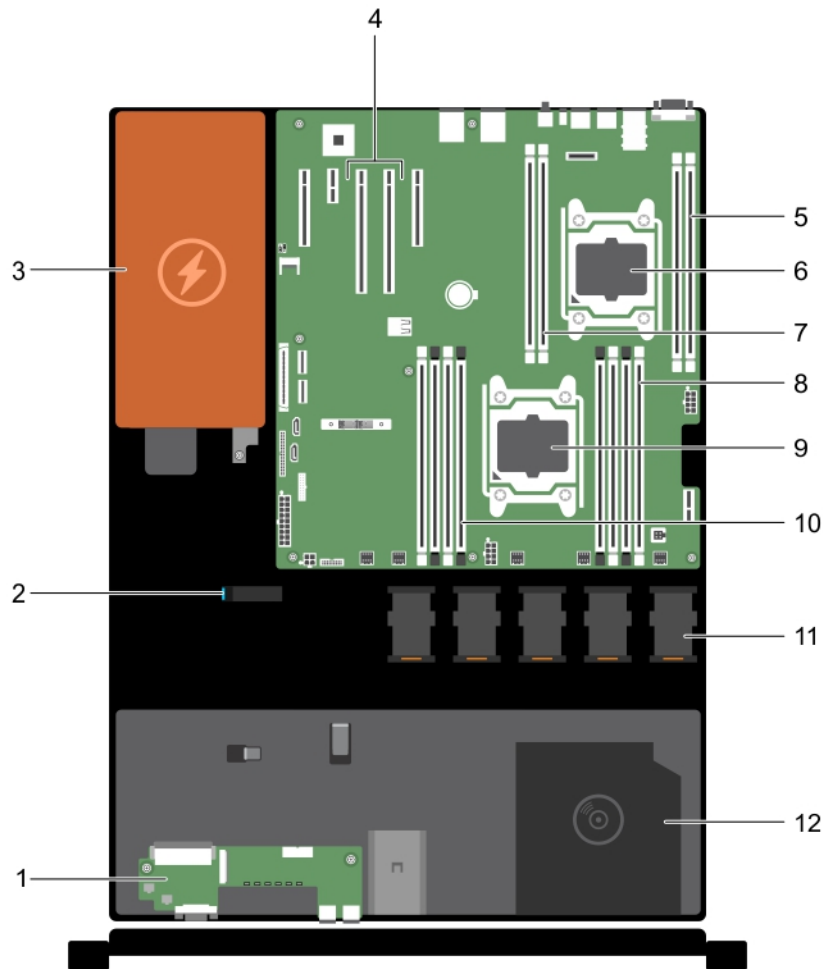

Figure 14. Inside the system—with a non-redundant power supply

- | | |
|----------------------------------|--|
| 1. control panel | 2. cable routing latch |
| 3. power supply unit | 4. expansion-card riser connector (2) |
| 5. memory-module socket (B3, B4) | 6. processor 2 |
| 7. memory-module socket (B1, B2) | 8. memory-module socket (A1, A5, A2, A6) |

- 9. processor 1
- 10. memory-module socket (A3, A7, A4, A8)
- 11. cooling fan (5)
- 12. optical drive (optional)

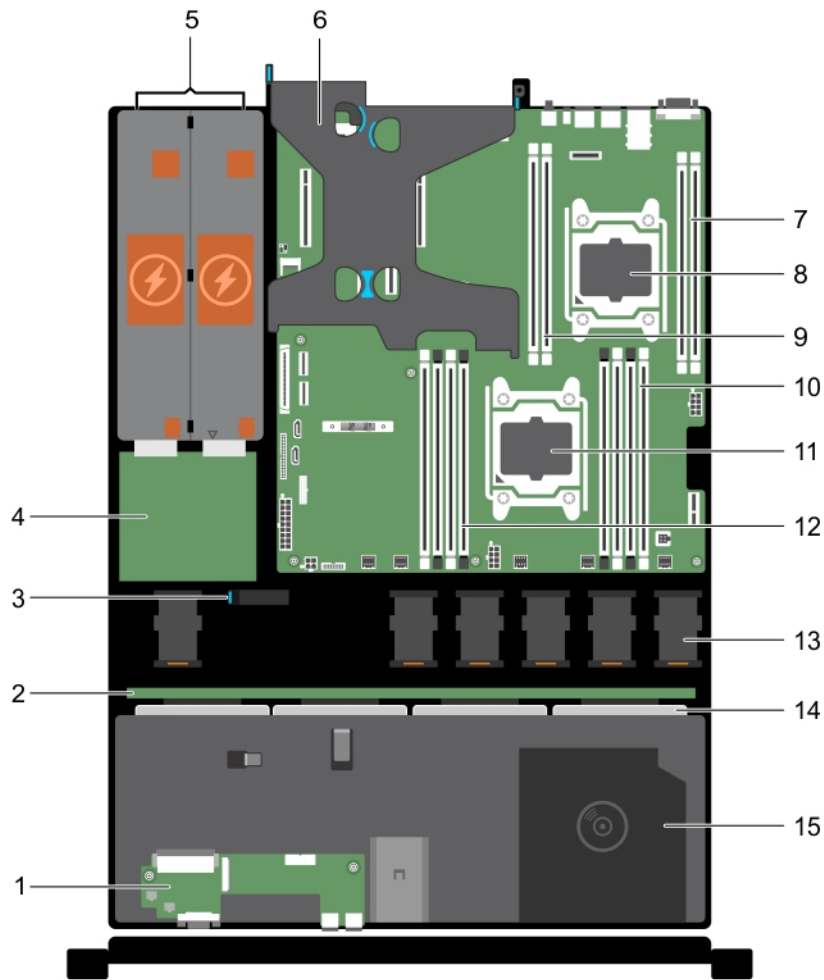

Figure 15. Inside the System—with redundant power supplies

- 1. control panel
- 2. hard drive/SSD backplane
- 3. cable routing latch
- 4. power interposer board
- 5. power supply units (2)
- 6. PCIe expansion card riser (optional)
- 7. memory-module socket (B3, B4)
- 8. processor 2
- 9. memory-module socket (B1, B2)
- 10. memory-module socket (A1, A5, A2, A6)
- 11. processor 1
- 12. memory-module socket (A3, A7, A4, A8)
- 13. cooling fan (6)
- 14. hard drives/SSDs
- 15. optical drive

Cooling shroud

Removing the cooling shroud

Prerequisites

CAUTION: Many repairs may only be done by a certified service technician. You should only perform troubleshooting and simple repairs as authorized in your product documentation, or as directed by the online or telephone service and support team. Damage due to servicing that is not authorized by Dell is not covered by your warranty. Read and follow the safety instructions that came with the product.

1. Ensure that you read the [Safety instructions](#).
2. Follow the procedure listed in [Before working inside your system](#).

CAUTION: Never operate your system with the cooling shroud removed. The system may get overheated quickly, resulting in shutdown of the system and loss of data.

Steps

Hold the touch points and lift the shroud away from the system.

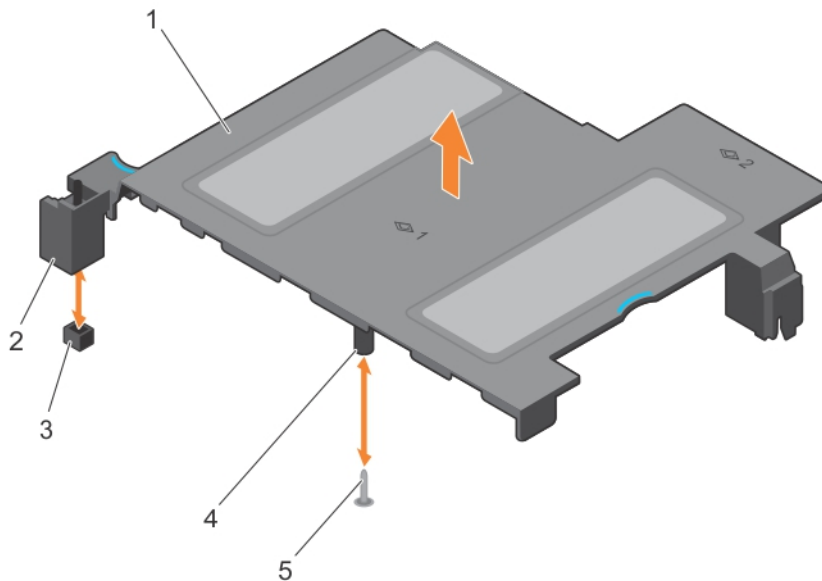

Figure 16. Removing and installing the cooling shroud

- | | |
|---|--------------------------------|
| 1. cooling shroud | 2. intrusion switch |
| 3. intrusion switch connector on the system board | 4. guide on the cooling shroud |
| 5. guide pin | |

Related Links

[Removing the front bezel](#)

[Removing the system cover](#)
[Installing the system cover](#)
[Installing the front bezel](#)

Installing the cooling shroud

Prerequisites

 **CAUTION:** Many repairs may only be done by a certified service technician. You should only perform troubleshooting and simple repairs as authorized in your product documentation, or as directed by the online or telephone service and support team. Damage due to servicing that is not authorized by Dell is not covered by your warranty. Read and follow the safety instructions that came with the product.

1. Ensure that you read the [Safety instructions](#).
2. Follow the procedure listed in [Before working inside your system](#).

Steps

1. Align the following:
 - a. guide on the cooling shroud with the guide pin on the system board.
 - b. intrusion switch with the intrusion switch connector on the system board.
2. Lower the cooling shroud into the chassis until it is firmly seated.
When firmly seated, the memory socket numbers marked on the cooling shroud align with the respective memory sockets.

Next steps

Follow the procedure listed in [After working inside your system](#).

Related Links

[Removing the front bezel](#)
[Installing the front bezel](#)

System memory

Your system supports DDR4 registered DIMMs (RDIMMs).

 **NOTE:** MT/s indicates DIMM speed in MegaTransfers per second.

Memory bus operating frequency can be 2133 MT/s, 1866 MT/s, 1600 MT/s, or 1333 MT/s depending on the following factors:

- System profile selected (for example, Performance Optimized, Custom, or Dense Configuration Optimized)
- Maximum supported DIMM frequency of the processors

The system contains 12 memory sockets split into four sets — two sets of 4 sockets and two sets of 2 sockets each. Each 4-socket set is organized into two channels and each 2-socket set is organized into one channel. In each channel of the 4-socket set, the release levers of the first socket are marked white and the second socket black. In the 2-socket set, each release lever is marked white.

 **NOTE:** DIMMs in sockets A1 to A8 are assigned to processor 1 and DIMMs in sockets B1 to B4 are assigned to processor 2.

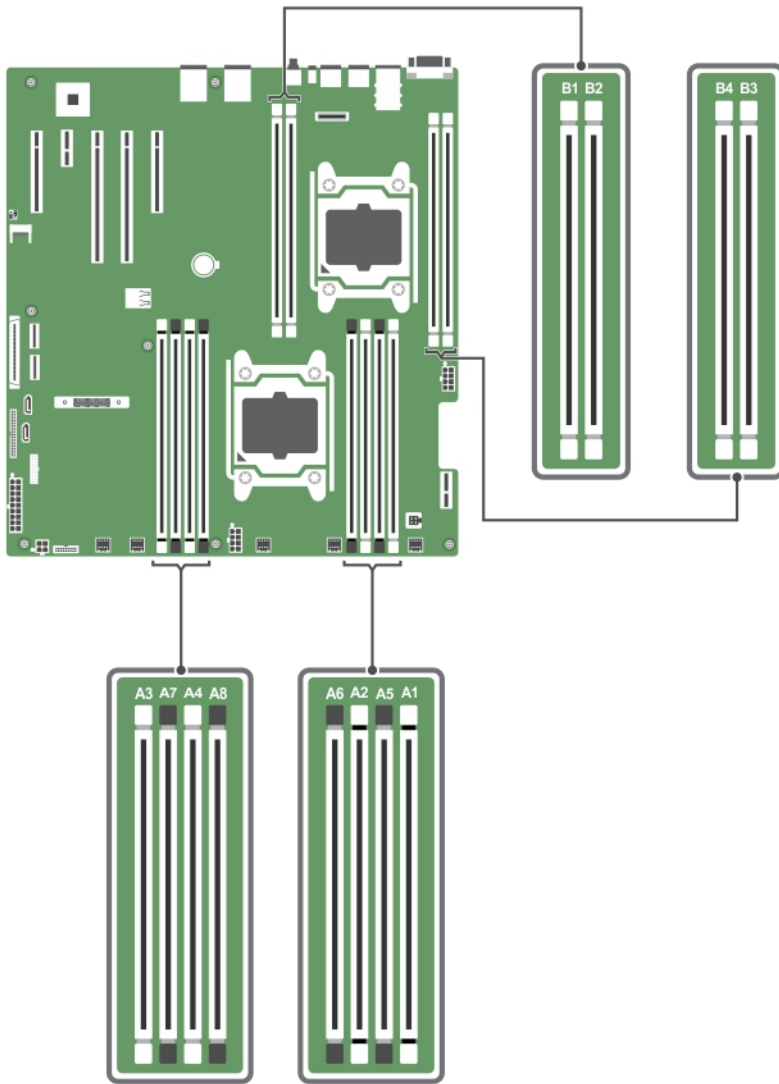

Memory channels are organized as follows:

- Processor 1**
- channel 0: memory sockets A1 and A5
 - channel 1: memory sockets A2 and A6
 - channel 2: memory sockets A3 and A7
 - channel 3: memory sockets A4 and A8
- Processor 2**
- channel 0: memory sockets B1
 - channel 1: memory sockets B2
 - channel 2: memory sockets B3
 - channel 3: memory sockets B4

The following table shows the memory populations and operating frequencies for the supported configurations.

DIMM Type	DIMMs Populated/ Channel	Operating Frequency (in MT/s)	Maximum DIMM Rank/Channel
1.2 V			
RDIMM	1	2133, 1866, 1600, 1333	Dual rank or single rank
	2	2133, 1866, 1600, 1333	Dual rank or single rank

General memory module installation guidelines

Your system supports Flexible Memory Configuration, enabling the system to be configured and run in any valid chipset architectural configuration. The following are the recommended guidelines for installing memory modules:

- x4 and x8 DRAM based DIMMs can be mixed. For more information, see [Mode-specific guidelines](#).
- Up to two dual- or single-rank RDIMMs can be populated per channel.
- Populate DIMM sockets only if a processor is installed. For single-processor systems, sockets A1 to A8 are available. For dual-processor systems, sockets A1 to A8 and sockets B1 to B4 are available.
- Populate all sockets with white release levers first, and then all the sockets with black release levers.
- When mixing memory modules with different capacities, populate the sockets with memory modules with highest capacity first. For example, if you want to mix 4 GB and 8 GB DIMMs, populate 8 GB DIMMs in the sockets with white release levers and 4 GB DIMMs in the sockets with black release levers.
- In a dual-processor configuration, the memory configuration for each processor should be identical through the first eight slots. For example, if you populate socket A1 for processor 1, then populate socket B1 for processor 2, and so on.
- Memory modules of different capacities can be mixed provided other memory population rules are followed (for example, 4 GB and 8 GB memory modules can be mixed).
- Mixing of more than two DIMM capacities in a system is not supported.
- Populate two DIMMs per processor (one DIMM per channel) at a time to maximize performance.

Mode-specific guidelines

Four memory channels are allocated to each processor. The allowable configurations depend on the memory mode selected.

 **NOTE:** You can mix x4 and x8 DRAM based DIMMs to support RAS features. However, all guidelines for specific RAS features must be followed. x4 DRAM based DIMMs retain Single Device Data Correction (SDDC) in memory optimized (independent channel) mode. x8 DRAM based DIMMs require Advanced ECC mode to gain SDDC.

The following sections provide additional slot population guidelines for each mode:

Advanced ECC (lockstep)

Advanced ECC mode extends SDDC from x4 DRAM based DIMMs to both x4 and x8 DRAMs. This protects against single DRAM chip failures during normal operation.

Memory installation guidelines:

- Memory modules must be identical in size, speed, and technology.

- DIMMs installed in memory sockets with white release levers must be identical and similar rule applies for sockets with black release levers. This ensures that identical DIMMs are installed in matched pairs - for example, A1 with A2, A3 with A4, A5 with A6, and so on.

 **NOTE:** Advanced ECC with Mirroring is not supported.

Memory optimized (independent channel) mode

This mode supports SDDC only for memory modules that use x4 device width, and the mode does not impose any specific slot population requirements.

Memory sparing

 **NOTE:** To use memory sparing, this feature must be enabled in the System Setup.

In this mode, one rank per channel is reserved as a spare. If persistent correctable errors are detected on a rank, the data from this rank is copied to the spare rank and the failed rank is disabled.

With memory sparing enabled, the system memory available to the operating system is reduced by one rank per channel. For example, in a dual-processor configuration with sixteen 4 GB dual-rank DIMMs, the available system memory is: 3/4 (ranks/channel) × 16 (DIMMs) × 4 GB = 48 GB, and not 16 (DIMMs) × 4 GB = 64 GB.

 **NOTE:** Memory sparing does not offer protection against a multi-bit uncorrectable error.

 **NOTE:** Both Advanced ECC/Lockstep and Optimizer modes support Memory Sparing.

Sample memory configurations

The following tables show sample memory configurations for one and two processor configurations that follow the appropriate memory guidelines.

 **NOTE:** 1R and 2R in the following tables indicate single- and dual-rank DIMMs respectively.

Table 1. Memory configurations—single processor

System Capacity (in GB)	DIMM Size (in GB)	Number of DIMMs	DIMM Rank, Organization, and Frequency	DIMM Slot Population
4	4	1	1R, x8, 2133 MT/s,	A1
			1R, x8, 1866 MT/s	
8	4	2	1R, x8, 2133 MT/s,	A1, A2
			1R, x8, 1866 MT/s	
16	4	4	1R, x8, 2133 MT/s,	A1, A2, A3, A4
			1R, x8, 1866 MT/s	
	8	2	2R, x8, 2133 MT/s,	
			2R, x8, 1866 MT/s	

System Capacity (in GB)	DIMM Size (in GB)	Number of DIMMs	DIMM Rank, Organization, and Frequency	DIMM Slot Population
24	4	6	1R, x8, 2133 MT/s, 1R, x8, 1866 MT/s	A1, A2, A3, A4, A5, A6
48	8	6	2R, x8, 2133 MT/s, 2R, x8, 1866 MT/s	A1, A2, A3, A4, A5, A6
96	16	6	2R, x4, 2133 MT/s, 2R, x4, 1866 MT/s	A1, A2, A3, A4, A5, A6
128	16	8	2R, x4, 2133 MT/s, 2R, x4, 1866 MT/s,	A1, A2, A3, A4, A5, A6, A7, A8
192	32	6	RDIMM, 2R, x4, 2133 MT/s RDIMM, 2R, x4, 1866 MT/s	A1, A2, A3, A4, A5, A6

Table 2. Memory configurations—two processors

System Capacity (in GB)	DIMM Size (in GB)	Number of DIMMs	DIMM Rank, Organization, and Frequency	DIMM Slot Population
16	4	4	1R, x8, 2133 MT/s, 1R, x8, 1866 MT/s	A1, A2, B1, B2
32	4	8	1R, x8, 2133 MT/s, 1R, x8, 1866 MT/s	A1, A2, A3, A4, B1, B2, B3, B4
64	8	8	2R, x8, 2133 MT/s, 2R, x8, 1866 MT/s	A1, A2, A3, A4, B1, B2, B3, B4
96	8	12	2R, x8, 2133 MT/s, 2R, x8, 1866 MT/s	A1, A2, A3, A4, A5, A6, A7, A8, B1, B2, B3, B4
128	16	8	2R, x4, 2133 MT/s, 2R, x4, 1866 MT/s	A1, A2, A3, A4, B1, B2, B3, B4
160	16 and 8	12	2R, x4, 2133 MT/s, 2R, x8, 2133 MT/s, 2R, x4, 1866 MT/s	A1, A2, A3, A4, A5, A6, A7, A8, B1, B2, B3, B4

System Capacity (in GB)	DIMM Size (in GB)	Number of DIMMs	DIMM Rank, Organization, and Frequency	DIMM Slot Population
			2R, x8, 1866 MT/s	 NOTE: 16 GB DIMMs must be installed in slots numbered A1, A2, A3, A4, B1, B2, B3, and B4 and 8 GB DIMMs must be installed in slots A5, A6, A7, and A8.
192	16	12	2R, x4, 2133 MT/s, 2R, x4, 1866 MT/s	A1, A2, A3, A4, A5, A6,A7,A8, B1, B2, B3, B4
384	32	12	RDIMM, 2R, x4, 2133 MT/s RDIMM, 2R, x4, 1866 MT/s	A1, A2, A3, A4, A5, A6,A7,A8, B1, B2, B3, B4

Removing memory module

Prerequisites

 **CAUTION:** Many repairs may only be done by a certified service technician. You should only perform troubleshooting and simple repairs as authorized in your product documentation, or as directed by the online or telephone service and support team. Damage due to servicing that is not authorized by Dell is not covered by your warranty. Read and follow the safety instructions that came with the product.

1. Ensure that you read the [Safety instructions](#).
2. Follow the procedure listed in [Before working inside your system](#).
3. Remove the cooling shroud.

 **WARNING:** The memory modules are hot to the touch for some time after the system has been powered down. Allow time for the memory modules to cool before handling them. Handle the memory modules by the card edges and avoid touching the components or metallic contacts on the memory module.

 **CAUTION:** To ensure proper system cooling, memory-module blanks must be installed in any memory socket that is not occupied. Remove memory-module blanks only if you intend to install memory modules in those sockets.

Steps

1. Locate the appropriate memory module socket.

 **CAUTION:** Handle each memory module only by the card edges, making sure not to touch the middle of the memory module or metallic contacts.

2. To release the memory module from the socket, simultaneously press the ejectors on both ends of the memory-module socket.

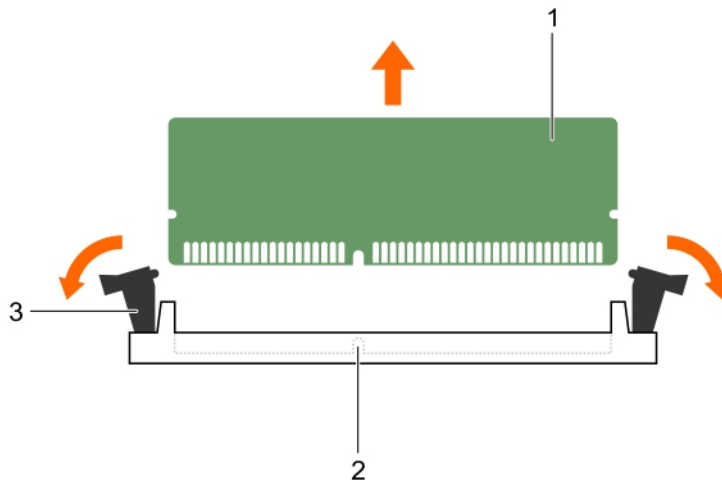

Figure 17. Removing memory module

- | | |
|------------------------------|-------------------------|
| 1. memory-module | 2. memory-module socket |
| 3. memory module ejector (2) | |

Related Links

[Removing the cooling shroud](#)

Installing memory modules

Prerequisites

CAUTION: Many repairs may only be done by a certified service technician. You should only perform troubleshooting and simple repairs as authorized in your product documentation, or as directed by the online or telephone service and support team. Damage due to servicing that is not authorized by Dell is not covered by your warranty. Read and follow the safety instructions that came with the product.

1. Ensure that you read the [Safety instructions](#).
2. Follow the procedure listed in [Before working inside your system](#).
3. Remove the cooling shroud.

WARNING: The memory modules are hot to the touch for some time after the system has been powered down. Allow time for the memory modules to cool before handling them. Handle the memory modules by the card edges and avoid touching the components or metallic contacts on the memory module.

Steps

1. Locate the appropriate memory-module socket.

CAUTION: Handle each memory module only by the card edges, making sure not to touch the middle of the memory module or metallic contacts.

2. If a memory module or a memory-module blank is installed in the socket, remove it.

 **NOTE:** Retain the removed memory-module blank(s) for future use.

 **CAUTION:** To prevent damage to the memory module or the memory-module socket during installation, do not bend or flex the memory module; insert both ends of the memory module simultaneously.

3. Align the edge connector of the memory module with the alignment key of the memory module socket, and insert the memory module in the socket.

 **NOTE:** The memory-module socket has an alignment key that allows you to install the memory module in the socket in only one orientation.

 **CAUTION:** Do not apply pressure at the center of the memory module; apply pressure at both ends of the memory module evenly.

4. Press the memory module with your thumbs until the socket levers firmly click into place.

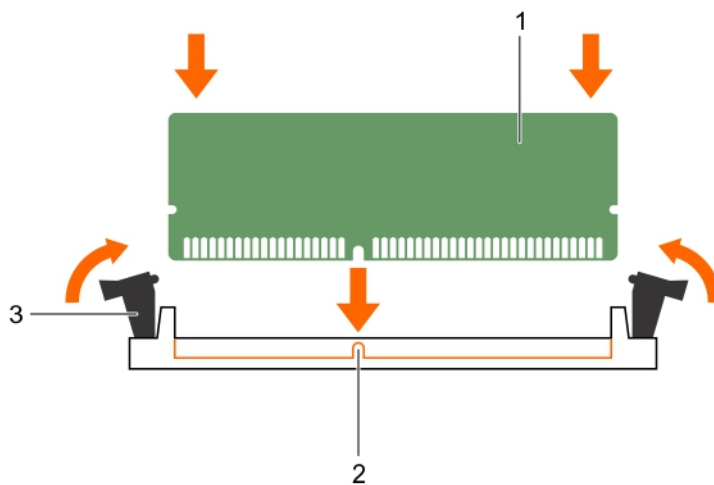

Figure 18. Installing the memory module

- | | |
|-------------------------------------|------------------|
| 1. memory module | 2. alignment key |
| 3. memory-module socket ejector (2) | |

When the memory module is properly seated in the socket, the levers on the memory module socket align with the levers on the other sockets that have memory modules installed.

5. Repeat steps 3 and 4 of this procedure to install the remaining memory modules.

Next steps

1. Install the cooling shroud.
2. Follow the procedure listed in [After working inside your system](#).
3. Press <F2> to enter System Setup, and check the **System Memory** setting. The **System Memory** value should reflect the newly installed memory.
4. If the value is incorrect, one or more of the memory modules may not be installed properly. Repeat step 3 and step 4 of this procedure, checking to ensure that the memory modules are firmly seated in their sockets.

5. Run the system memory test in the system diagnostics.

Related Links

[Removing the cooling shroud](#)

[Installing the cooling shroud](#)

Hard drives

Depending on the configuration, your system supports one of the following:

Four hard-drive systems	Up to four 3.5 inch cabled hard drives, or Up to four 3.5 inch hot-swappable SAS HDD, SATA HDD, or SATA SSD or Up to four 2.5 inch hot-swappable SAS HDD, SATA HDD, or SATA SSD
Eight hard-drive systems	Up to eight 2.5 inch hot-swappable SAS HDD, SATA HDD, or SATA SSD
Ten hard-drive systems	Up to ten 2.5 inch hot-swappable SATA HDD or SATA SSD

 **NOTE:** SSD/SAS/SATA hard drives cannot be mixed in a system.

The hot-swappable hard drives connect to the system board through the hard-drive backplane. Hot-swappable hard drives are supplied in hot-swappable hard-drive carriers that fit in the hard-drive slots.

 **CAUTION:** Before attempting to remove or install a hot-swappable hard drive while the system is running, see the documentation for the storage controller card to ensure that the host adapter is configured correctly to support hot-swap hard drive removal and insertion.

 **CAUTION:** Do not turn off or reboot your system while the hard drive is being formatted. Doing so can cause a hard drive failure.

 **NOTE:** Use only hard drives that have been tested and approved for use with the hard-drive backplane.

When you format a hard drive, allow enough time for the formatting to be completed. Be aware that high-capacity hard drives can take a number of hours to format.

Removing a 2.5 inch hard-drive blank

Prerequisites

 **CAUTION:** Many repairs may only be done by a certified service technician. You should only perform troubleshooting and simple repairs as authorized in your product documentation, or as directed by the online or telephone service and support team. Damage due to servicing that is not authorized by Dell is not covered by your warranty. Read and follow the safety instructions that came with the product.

 **CAUTION:** To maintain proper system cooling, all empty hard-drive slots must have hard-drive blanks installed.

1. Ensure that you read the [Safety instructions](#).
2. If installed, remove the bezel.

Steps

Press the release button and slide the hard-drive blank out of the hard-drive slot.

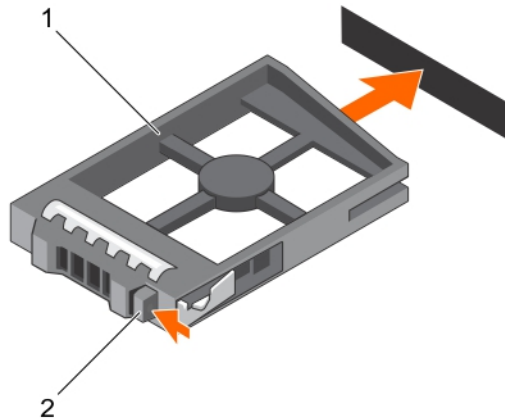

Figure 19. Removing and installing a 2.5 inch hard-drive blank

1. hard-drive blank
2. release button

Related Links

- [Removing the front bezel](#)
- [Installing the front bezel](#)

Installing a 2.5 inch hard-drive blank

Prerequisites

△ CAUTION: Many repairs may only be done by a certified service technician. You should only perform troubleshooting and simple repairs as authorized in your product documentation, or as directed by the online or telephone service and support team. Damage due to servicing that is not authorized by Dell is not covered by your warranty. Read and follow the safety instructions that came with the product.

1. Ensure that you read the [Safety instructions](#).
2. If installed, remove the front bezel.

Steps

Insert the hard-drive blank into the hard-drive slot until the release button clicks into place.

Next steps

If applicable, install the front bezel.

Related Links

- [Removing the front bezel](#)
- [Installing the front bezel](#)

Removing a 3.5 inch hard-drive blank

Prerequisites

CAUTION: Many repairs may only be done by a certified service technician. You should only perform troubleshooting and simple repairs as authorized in your product documentation, or as directed by the online or telephone service and support team. Damage due to servicing that is not authorized by Dell is not covered by your warranty. Read and follow the safety instructions that came with the product.

CAUTION: To maintain proper system cooling, all empty hard-drive slots must have drive blanks installed.

1. Ensure that you read the [Safety instructions](#).
2. If installed, remove the front bezel.

Steps

Press the release button and slide the blank out of the hard-drive slot.

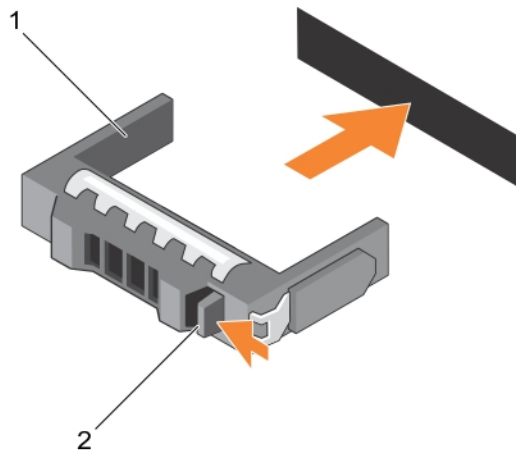

Figure 20. Removing and installing a 3.5 inch hard-drive blank

1. hard-drive blank

2. release button

Next steps

If applicable, install the front bezel.

Related Links

[Removing the front bezel](#)

[Installing the front bezel](#)

Installing a 3.5 inch hard-drive blank

Prerequisites

 **CAUTION:** Many repairs may only be done by a certified service technician. You should only perform troubleshooting and simple repairs as authorized in your product documentation, or as directed by the online or telephone service and support team. Damage due to servicing that is not authorized by Dell is not covered by your warranty. Read and follow the safety instructions that came with the product.

1. Ensure that you read the [Safety instructions](#).
2. If installed, remove the front bezel.

Steps

Insert the hard-drive blank into the hard-drive slot until the release button clicks into place.

Next steps

If applicable, install the front bezel.

Related Links

[Removing the front bezel](#)

[Installing the front bezel](#)

Removing a cabled hard drive

Prerequisites

 **CAUTION:** Many repairs may only be done by a certified service technician. You should only perform troubleshooting and simple repairs as authorized in your product documentation, or as directed by the online or telephone service and support team. Damage due to servicing that is not authorized by Dell is not covered by your warranty. Read and follow the safety instructions that came with the product.

1. Ensure that you read the [Safety instructions](#).
2. Follow the procedure listed in [Before working inside your system](#).

Steps

1. Disconnect the data/power cable from the hard drive.
2. Press the release tab on the hard-drive carrier and slide the hard drive out of the hard-drive bay.

 **CAUTION:** To maintain proper system cooling, all empty hard-drive slots must have hard-drive blanks installed.

3. Insert a hard-drive blank in the empty hard-drive slot.

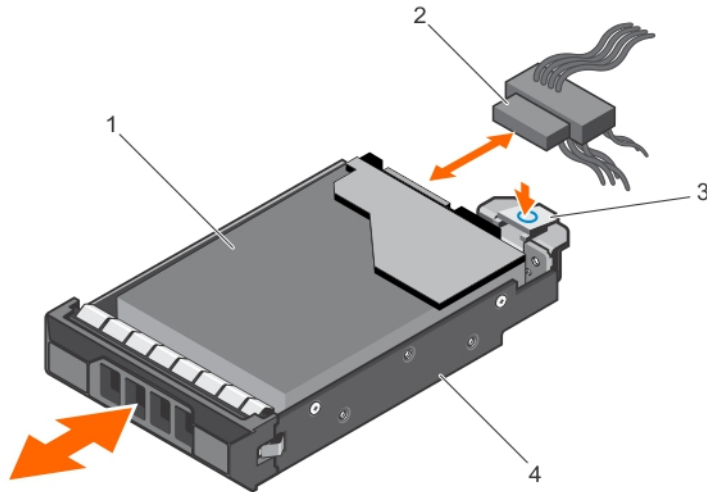

Figure 21. Removing and installing a cabled hard drive

- | | |
|----------------|-----------------------|
| 1. hard drive | 2. power/data cable |
| 3. release tab | 4. hard-drive carrier |

Installing a cabled hard drive

Prerequisites

CAUTION: Many repairs may only be done by a certified service technician. You should only perform troubleshooting and simple repairs as authorized in your product documentation, or as directed by the online or telephone service and support team. Damage due to servicing that is not authorized by Dell is not covered by your warranty. Read and follow the safety instructions that came with the product.

Ensure that you read the [Safety instructions](#).

Steps

1. Press the release tab on the hard-drive carrier and slide the carrier out of the system.
2. Install the hard drive into the hard-drive carrier.
3. Insert the hard-drive carrier into the hard-drive slot till it clicks into place.
4. Connect the power/data cable to the hard drive.
 - If connecting to the integrated SATA controller (SATA hard drives only), connect the SATA data cable to the SATA_A-D connector on the system board.
 - If connecting to a SAS RAID controller card (SAS or SATA hard drives), connect the data cable to the connector on the card.

Next steps

1. Follow the procedure listed in [After working inside your system](#).

2. Reconnect the system to its electrical outlet and turn the system on, including any attached peripherals.
3. Enter the System Setup and ensure that the hard drive's controller is enabled.
4. Exit the System Setup program and reboot the system.
5. Install any software required for the hard drive operation as described in the documentation for the hard drive.

Removing a hot-swap hard drive

Prerequisites

 **CAUTION: Many repairs may only be done by a certified service technician. You should only perform troubleshooting and simple repairs as authorized in your product documentation, or as directed by the online or telephone service and support team. Damage due to servicing that is not authorized by Dell is not covered by your warranty. Read and follow the safety instructions that came with the product.**

1. Ensure that you read the [Safety instructions](#).
2. If installed, remove the front bezel.
3. Using the management software, prepare the hard drive for removal. For more information, see the documentation for the storage controller.

If the hard drive is online, the green activity/fault indicator flashes as the drive is turned off. You can remove the hard-drive when the hard-drive indicators turn off.

 **CAUTION: To prevent data loss, ensure that your operating system supports hot-swap drive installation. See the documentation supplied with your operating system.**

Steps

1. Press the release button to open the hard-drive carrier release handle.
2. Slide the hard-drive carrier out of the hard-drive slot.

 **CAUTION: To maintain proper system cooling, all empty hard-drive slots must have hard-drive blanks installed.**

3. If you are not replacing the hard drive immediately, insert a hard-drive blank in the empty hard-drive slot.

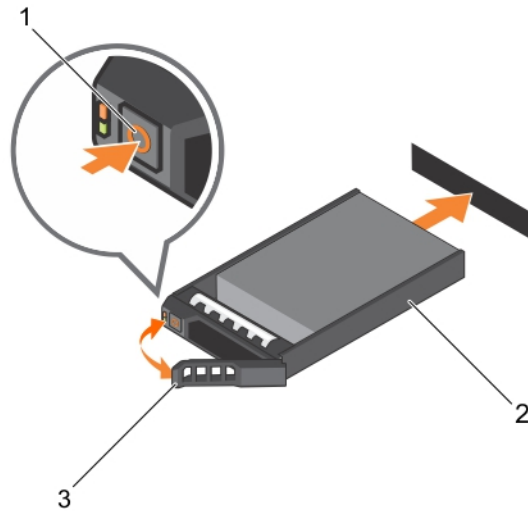

Figure 22. Removing and installing a hot-swap hard drive

- | | |
|------------------------------|-----------------------|
| 1. release button | 2. hard-drive carrier |
| 3. hard-drive carrier handle | |

Next steps

If removed, install the front bezel.

Installing a hot-swap hard drive

Prerequisites

- △ **CAUTION:** Many repairs may only be done by a certified service technician. You should only perform troubleshooting and simple repairs as authorized in your product documentation, or as directed by the online or telephone service and support team. Damage due to servicing that is not authorized by Dell is not covered by your warranty. Read and follow the safety instructions that came with the product.
- △ **CAUTION:** Use only hard drives that have been tested and approved for use with the hard-drive backplane.
- △ **CAUTION:** Combining SAS and SATA hard drives in the same RAID volume is not supported.
- △ **CAUTION:** When installing a hard drive, ensure that the adjacent drives are fully installed. Inserting a hard-drive carrier and attempting to lock its handle next to a partially installed carrier can damage the partially installed carrier's shield spring and make it unusable.
- △ **CAUTION:** To prevent data loss, ensure that your operating system supports hot-swap drive installation. See the documentation supplied with your operating system.
- △ **CAUTION:** When a replacement hot-swappable hard drive is installed and the system is powered on, the hard drive automatically begins to rebuild. Make absolutely sure that the replacement hard drive is blank or contains data that you wish to have over-written. Any data on the replacement hard drive is immediately lost after the hard drive is installed.

Steps

1. If a hard-drive blank is installed in the hard-drive slot, remove it.
2. Install a hard drive in the hard-drive carrier.
3. Press the release button on the front of the hard-drive carrier and open the hard-drive carrier handle.
4. Insert the hard-drive carrier into the hard-drive slot until the carrier comes in contact with the backplane.
5. Close the hard-drive carrier handle to lock the hard drive in place.

Next steps

If applicable, install the front bezel.

Installing a 2.5 inch hard drive into a 3.5 inch hard-drive adapter

Prerequisites

⚠ CAUTION: Many repairs may only be done by a certified service technician. You should only perform troubleshooting and simple repairs as authorized in your product documentation, or as directed by the online or telephone service and support team. Damage due to servicing that is not authorized by Dell is not covered by your warranty. Read and follow the safety instructions that came with the product.

1. Keep the #2 Phillips screwdriver ready.
2. Ensure that you read the [Safety instructions](#).

Steps

1. Align the screw holes on the 2.5 inch hard drive with the screw holes on the 3.5 inch hard-drive adapter.
2. Install the screws to secure the hard drive to the hard-drive adapter.

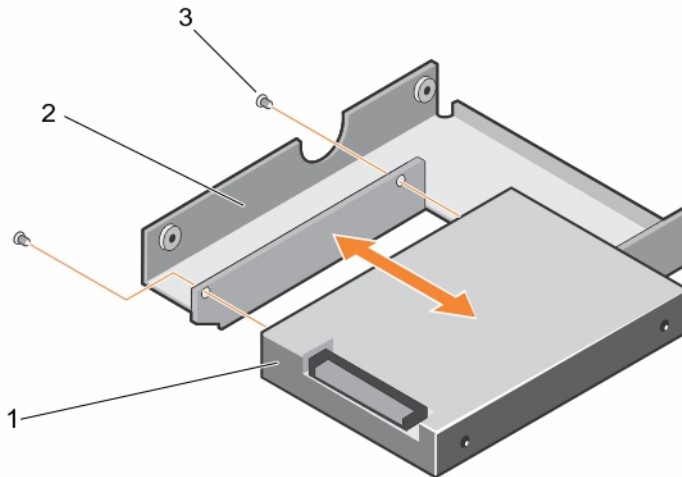



Figure 23. Removing and Installing a 2.5 inch hard drive into a 3.5 inch hard-drive adapter

1. 2.5 inch hard drive
2. 3.5 inch hard-drive adapter
3. screw (2)

Removing a 2.5 inch hard drive from a 3.5 inch hard-drive adapter

Prerequisites

 **CAUTION:** Many repairs may only be done by a certified service technician. You should only perform troubleshooting and simple repairs as authorized in your product documentation, or as directed by the online or telephone service and support team. Damage due to servicing that is not authorized by Dell is not covered by your warranty. Read and follow the safety instructions that came with the product.

1. Ensure that you read the [Safety instructions](#).
2. Keep the #2 Phillips screwdriver ready.

 **NOTE:** A 2.5 inch hard drive is installed in a 3.5 inch hard-drive adapter, which is then installed in the 3.5 inch hard-drive carrier.

Steps

1. Remove the screws from the side of the 3.5 inch hard-drive adapter.
2. Remove the hard drive from the hard-drive adapter.

Installing a hard-drive adapter into a hard-drive carrier

Prerequisites

 **CAUTION:** Many repairs may only be done by a certified service technician. You should only perform troubleshooting and simple repairs as authorized in your product documentation, or as directed by the online or telephone service and support team. Damage due to servicing that is not authorized by Dell is not covered by your warranty. Read and follow the safety instructions that came with the product.

1. Ensure that you read the [Safety instructions](#).
2. Keep the #2 Phillips screwdriver ready.

Steps

1. Insert the hard-drive adapter into the hard-drive carrier with the connector end of the hard drive toward the back of the hard-drive carrier.
2. Align the screw holes on the hard drive with the holes on the hard-drive carrier.
3. Install the screws to secure the hard drive to the hard-drive carrier.

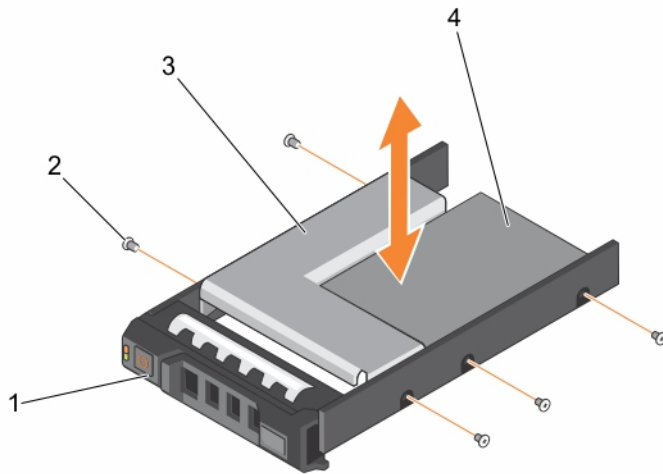

Figure 24. Removing and installing a hard-drive adapter into a 3.5 inch hard-drive carrier

- | | |
|--------------------------------|------------------------|
| 1. 3.5 inch hard-drive carrier | 2. screw (5) |
| 3. hard-drive adapter | 4. 2.5 inch hard drive |

Removing a hard-drive adapter from a hard-drive carrier

Prerequisites

1. Ensure that you read the [Safety instructions](#).
2. Keep the #2 Phillips screwdriver ready.

Steps

1. Remove the screws from the slide rails on the hard-drive carrier.
2. Lift the hard-drive adapter out of the hard-drive carrier.

Removing a hard drive from a hard-drive carrier

Prerequisites

1. Keep the #2 Phillips screwdriver ready.
2. Remove the hard-drive carrier from the system.

Steps

1. Remove the screws from the slide rails on the hard-drive carrier.
2. Lift the hard drive out of the hard-drive carrier.

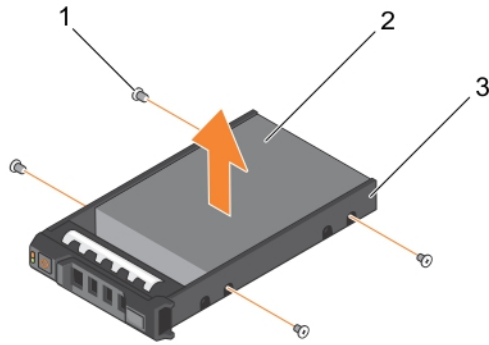

Figure 25. Removing and installing a hard drive into a hard-drive carrier

1. screw (4)
2. hard drive
3. hard-drive carrier

Installing a hard drive into a hard-drive carrier

Prerequisites

⚠ CAUTION: Many repairs may only be done by a certified service technician. You should only perform troubleshooting and simple repairs as authorized in your product documentation, or as directed by the online or telephone service and support team. Damage due to servicing that is not authorized by Dell is not covered by your warranty. Read and follow the safety instructions that came with the product.

Keep the #1 Phillips screwdriver handy.

Steps

1. Insert the hard drive into the hard-drive carrier with the connector end of the hard drive toward the back.
2. Align the screw holes on the hard drive with the set of screw holes on the hard-drive carrier. When aligned correctly, the back of the hard drive is flush with the back of the hard-drive carrier.
3. Attach the screws to secure the hard drive to the hard-drive carrier.

Optical drive (optional)

Removing an ultra slim optical drive

Prerequisites

⚠ CAUTION: Many repairs may only be done by a certified service technician. You should only perform troubleshooting and simple repairs as authorized in your product documentation, or as directed by the online or telephone service and support team. Damage due to servicing that is not authorized by Dell is not covered by your warranty. Read and follow the safety instructions that came with the product.

1. Ensure that you read the [Safety instructions](#).
2. Follow the procedure listed in [Before working inside your system](#).

Steps

1. Disconnect the power/data cable from the back of the optical drive.
Observe the routing of the power and data cable inside the chassis as you remove them from the system board and the drive. You must route these cables properly when you replace them to prevent them from being pinched or crimped.
2. To release the optical drive, press and push the release tab toward the front of the system.
3. Slide the optical drive out of the system until it is free of the optical-drive slot.
4. If you are not adding a new optical drive, install the optical-drive blank.

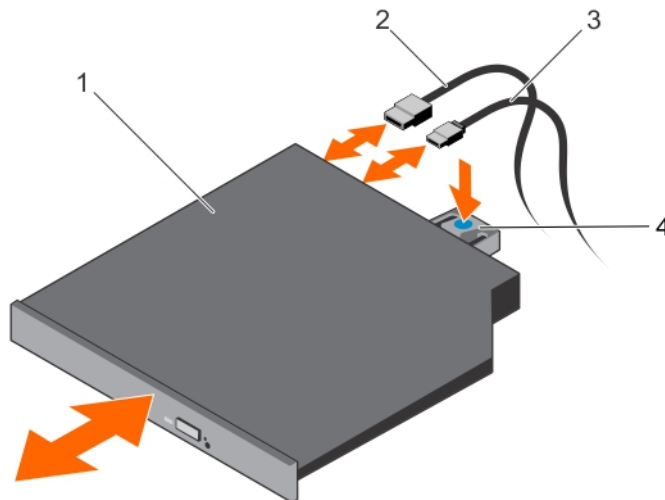

Figure 26. Removing and installing an ultra slim optical drive

- | | |
|------------------|----------------|
| 1. optical drive | 2. data cable |
| 3. power cable | 4. release tab |

Next steps

Follow the procedure listed in [After working inside your system](#).

Installing an ultra slim optical drive

Prerequisites

⚠ CAUTION: Many repairs may only be done by a certified service technician. You should only perform troubleshooting and simple repairs as authorized in your product documentation, or as directed by the online or telephone service and support team. Damage due to servicing that is not authorized by Dell is not covered by your warranty. Read and follow the safety instructions that came with the product.

1. Ensure that you read the [Safety instructions](#).
2. Follow the procedure listed in [Before working inside your system](#).

Steps

1. To remove the optical drive blank, press the blue release tab at the back of the blank and push the blank out of the system.
2. Align the optical drive with the optical drive slot on the front of chassis.
3. Slide the optical drive into the slot until the latch snaps into place.
4. Connect the power/data cable to the back of the drive.
5. Route the power/data cable underneath the cable routing latch of the system.
6. Connect the power/data cable to the connectors on the system board.

Next steps

1. Follow the procedure listed in [After working inside your system](#).

Removing the standard optical drive

Prerequisites



CAUTION: Many repairs may only be done by a certified service technician. You should only perform troubleshooting and simple repairs as authorized in your product documentation, or as directed by the online or telephone service and support team. Damage due to servicing that is not authorized by Dell is not covered by your warranty. Read and follow the safety instructions that came with the product.

1. Ensure that you read the [Safety instructions](#).
2. Follow the procedure listed in [Before working inside your system](#).

Steps

1. Disconnect the power/data cable from the back of the optical drive.
Observe the routing of the power and data cable inside the chassis as you remove them from the system board and the drive. You must route these cables properly when you replace them to prevent them from being pinched or crimped.
2. Pull the release latch and disengage the optical drive from the notches on the metal standoffs.
3. Lift the optical drive out of the system.
4. If you are not adding a new optical drive, install the optical-drive blank.

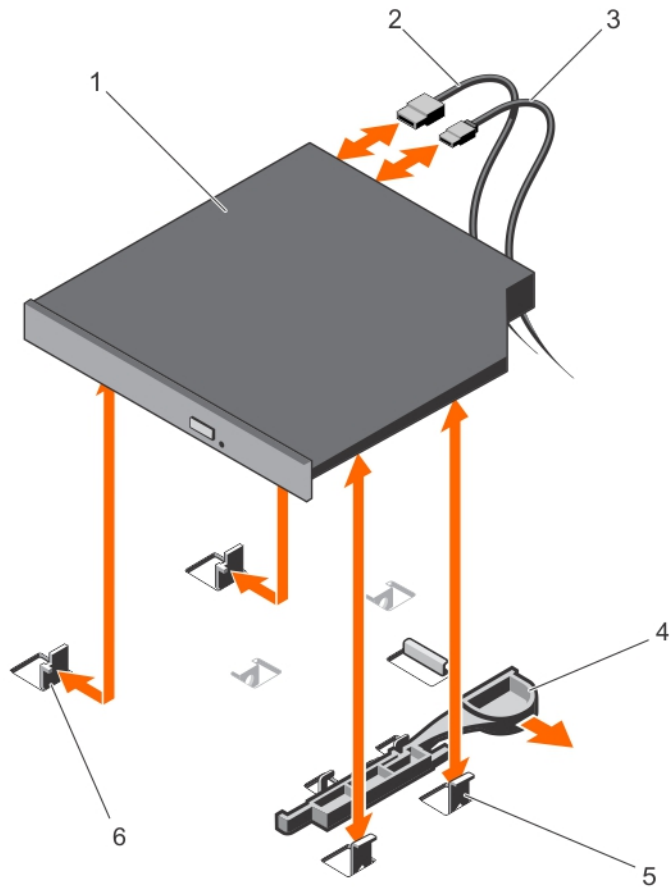

Figure 27. Removing and installing the standard optical drive

- | | |
|-----------------------|------------------------------------|
| 1. optical drive | 2. data cable |
| 3. power cable | 4. release latch |
| 5. metal standoff (4) | 6. notch on the metal standoff (2) |

Next steps

Follow the procedure listed in [After working inside your system.](#)

Installing the standard optical drive

Prerequisites

⚠ CAUTION: Many repairs may only be done by a certified service technician. You should only perform troubleshooting and simple repairs as authorized in your product documentation, or as directed by the online or telephone service and support team. Damage due to servicing that is not authorized by Dell is not covered by your warranty. Read and follow the safety instructions that came with the product.

1. Ensure that you read the [Safety instructions.](#)
2. Follow the procedure listed in [Before working inside your system.](#)

Steps

1. Align the two notches on the metal standoffs with the slots on the side of the optical drive.
2. Slide the optical drive into the notches until it is seated firmly and the release latch snaps into place.
3. Connect the power cable.
4. Connect the data cable to the back of the drive and to the SATA connector on the system board.

 **NOTE:** Route and secure the cables using the cable routing latch on the system chassis to prevent them from being pinched or crimped.

Next steps

Follow the procedure listed in [After working inside your system](#).

Cooling fans

Your system supports:

- Up to five cooling fans in a non-redundant power supply configuration.
- Up to six cooling fans in a redundant power supply configuration.

 **NOTE:** Fan 1 must be installed in a redundant power supply configuration.

 **NOTE:** Hot-swap removal or installation of the fans is not supported.

 **NOTE:** Each fan is listed in the system's management software, referenced by the respective fan number. If there is a problem with a particular fan, you can easily identify and replace the proper fan by noting the fan numbers on the cooling fan assembly.

Removing a cooling fan

Prerequisites

 **CAUTION:** Many repairs may only be done by a certified service technician. You should only perform troubleshooting and simple repairs as authorized in your product documentation, or as directed by the online or telephone service and support team. Damage due to servicing that is not authorized by Dell is not covered by your warranty. Read and follow the safety instructions that came with the product.

 **NOTE:** The procedure for removing each fan is identical.

1. Ensure that you read the [Safety instructions](#).
2. Follow the procedure listed in [Before working inside your system](#).
3. If installed, remove the cooling shroud.

Steps

1. Disconnect the fan's power cable from the power cable connector on the system board or power interposer board as applicable.
2. Lift the fan out of the cooling-fan bracket.

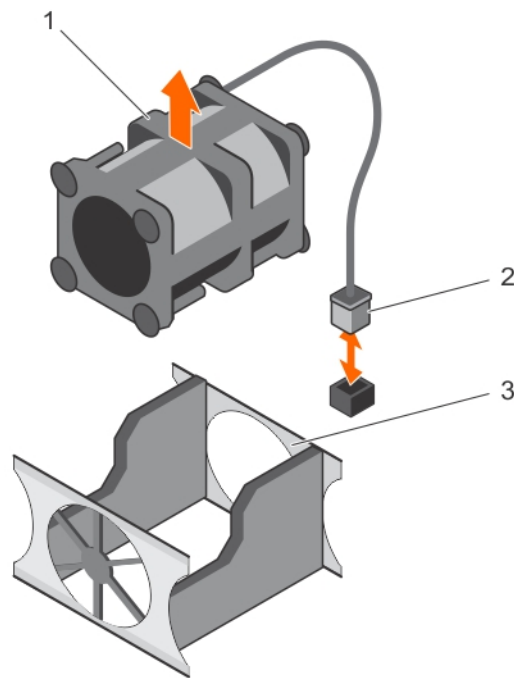

Figure 28. Removing and installing a cooling fan

1. cooling fan
2. power cable connector
3. cooling-fan bracket

Related Links

[Removing the cooling shroud](#)

Installing a cooling fan

Prerequisites

⚠ CAUTION: Many repairs may only be done by a certified service technician. You should only perform troubleshooting and simple repairs as authorized in your product documentation, or as directed by the online or telephone service and support team. Damage due to servicing that is not authorized by Dell is not covered by your warranty. Read and follow the safety instructions that came with the product.

1. Ensure that you read the [Safety instructions](#).
2. Remove the cooling shroud.

Steps

1. Facing the front of the system, lower the fan into the cooling-fan bracket.
✍ NOTE: When aligned correctly, the fan cable is on the left of the fan.
2. Connect the fan's power cable to the power cable connector on the system board as applicable.
3. Install the cooling shroud.

Next steps

Follow the procedure listed in [After working inside your system](#).

Related Links

[Removing the cooling shroud](#)

[Installing the cooling shroud](#)

Internal USB memory key (optional)

The USB memory key installed inside your system can be used as a boot device, security key, or mass storage device.

To boot from the USB memory key, configure the USB memory key with a boot image and then specify the USB memory key in the boot sequence in the System Setup.

 **NOTE:** The internal USB connector is located on the system board.

Related Links

[System board connectors](#)

Replacing the internal USB key

Prerequisites

 **CAUTION:** Many repairs may only be done by a certified service technician. You should only perform troubleshooting and simple repairs as authorized in your product documentation, or as directed by the online or telephone service and support team. Damage due to servicing that is not authorized by Dell is not covered by your warranty. Read and follow the safety instructions that came with the product.

1. Ensure that you read the [Safety instructions](#).
2. Follow the procedure listed in [Before working inside your system](#)

Steps

1. Locate the USB connector/USB key on the system board.
To locate the USB connector, see [System board connectors](#).
2. If installed, remove the USB key.
3. Insert the USB key into the USB connector.

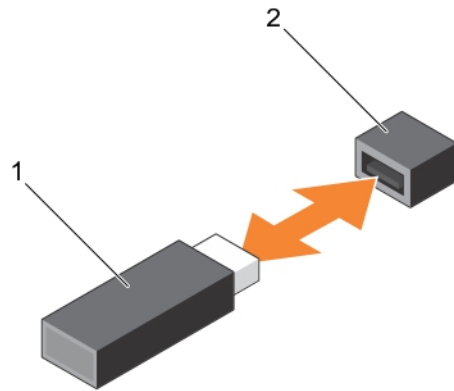

Figure 29. Replacing the internal USB key

1. USB memory key
2. USB memory key connector

Next steps

1. Follow the procedure listed in [After working inside your system](#).
2. While booting, press <F2> to enter the **System Setup** and verify that the USB key is detected by the system.

Expansion cards and expansion-card risers (optional)

NOTE: A missing or an unsupported expansion-card riser logs an SEL event. It does not prevent your system from powering on and no BIOS POST message or F1/F2 pause is displayed.

Expansion card installation guidelines

Your system supports Generation 1, Generation 2, and Generation 3 cards. The following table provides riser configurations for R430 systems:

Table 3. Expansion card slots available on the expansion-card riser

Expansion-card riser	PCIe slot on the expansion-card riser	Processor connection	Height	Length	Link width	Slot width
PCIe_G3_X16	1	Processor 1	Half Height	Half Length	x16	x16
	2	Processor 1	Half Height	Half Length	x16	x16
PCIe_G3_X8	1	Processor 1	Full Height	Half Length	x8	x16

Expansion-card riser	PCIe slot on the expansion-card riser	Processor connection	Height	Length	Link width	Slot width
	2	Processor 1	Half Height	Half Height	x8	x16

 **NOTE:** The PCIe_G3_X8 and PCIe_G3_X16 are the two different types of risers supported on R430 systems. You can install an expansion card on the system board only using expansion-card riser.

 **NOTE:** The expansion cards are not hot-swappable.

The following table provides a guide for installing expansion cards to ensure proper cooling and mechanical fit. The expansion cards with the highest priority must be installed first using the slot priority indicated. All other expansion cards must be installed in card priority and slot priority order.

Table 4. Expansion card installation order

Card priority	Card type	Slot priority	Maximum allowed
1	RAID	1, 2	2
2	56 Gb Infiniband NICs	1,2	2
3	10 Gb NICs	1, 2	2
4	FC8 HBA	1, 2	2
5	1 Gb NICs	1, 2	2
6	Non-RAID	1, 2	2

Removing the expansion-card riser

Prerequisites

 **CAUTION:** Many repairs may only be done by a certified service technician. You should only perform troubleshooting and simple repairs as authorized in your product documentation, or as directed by the online or telephone service and support team. Damage due to servicing that is not authorized by Dell is not covered by your warranty. Read and follow the safety instructions that came with the product.

1. Ensure that you read the [Safety instructions](#).
2. Follow the procedure listed in [Before working inside your system](#).

Steps

Holding the touch points, lift the expansion-card riser from the riser connector on the system board.

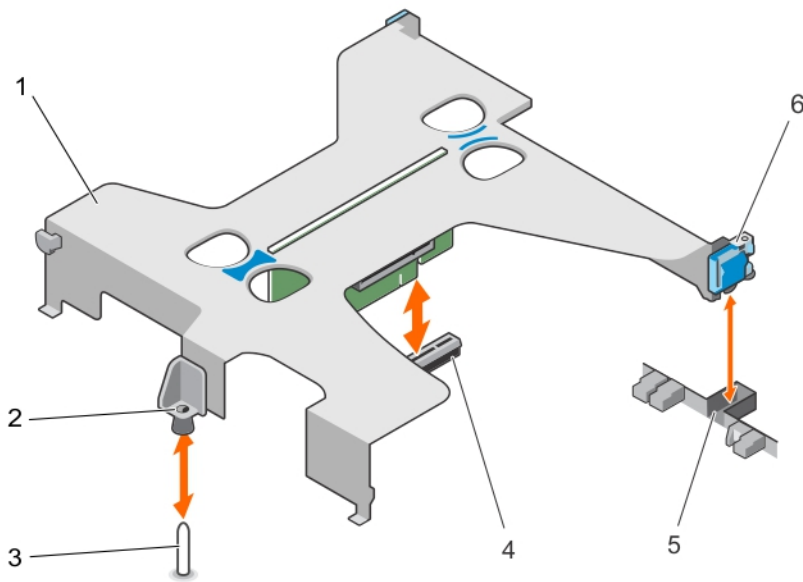

Figure 30. Removing and installing the expansion-card riser

- | | |
|----------------------------------|--|
| 1. expansion-card riser | 2. guide on the expansion-card riser |
| 3. guide pin on the system board | 4. expansion-riser connector on the system board |
| 5. slot on the chassis | 6. expansion-card latch |

Next steps

1. Install the expansion card, if applicable.
2. Install the expansion-card riser.
3. Follow the procedure listed in [After working inside your system](#).

Related Links

- [Removing an expansion card](#)
- [Installing an expansion card](#)
- [Installing the expansion-card riser](#)

Installing the expansion-card riser

Prerequisites

⚠ CAUTION: Many repairs may only be done by a certified service technician. You should only perform troubleshooting and simple repairs as authorized in your product documentation, or as directed by the online or telephone service and support team. Damage due to servicing that is not authorized by Dell is not covered by your warranty. Read and follow the safety instructions that came with the product.

Ensure that you read the [Safety instructions](#).

Steps

1. If applicable, reinstall the expansion card into the expansion-card riser.
2. Align the following:
 - a. guide on the expansion-card riser with the guide pin on the system board.
 - b. expansion-card riser latch with the slot on the chassis.
3. Lower the expansion-card riser until the expansion-card riser is fully seated in the connector.

Next steps

Follow the procedure listed in [After working inside your system](#).

Related Links

[Removing an expansion card](#)

[Installing an expansion card](#)

Removing an expansion card

Prerequisites



CAUTION: Many repairs may only be done by a certified service technician. You should only perform troubleshooting and simple repairs as authorized in your product documentation, or as directed by the online or telephone service and support team. Damage due to servicing that is not authorized by Dell is not covered by your warranty. Read and follow the safety instructions that came with the product.

1. Ensure that you read the [Safety instructions](#).
2. Follow the procedure listed in [Before working inside your system](#).

Steps

1. Disconnect any cables connected to the expansion card or expansion-card riser.
2. If installed, remove the expansion-card riser.
3. Hold the expansion card by its edges and remove it from the expansion-card connector on the riser.
4. If you are removing the card permanently, install a metal filler bracket over the empty expansion slot and close the expansion-card latch.



NOTE: You must install a filler bracket over an empty expansion slot to maintain Federal Communications Commission (FCC) certification of the system. The brackets also keep dust and dirt out of the system and aid in proper cooling and airflow inside the system.

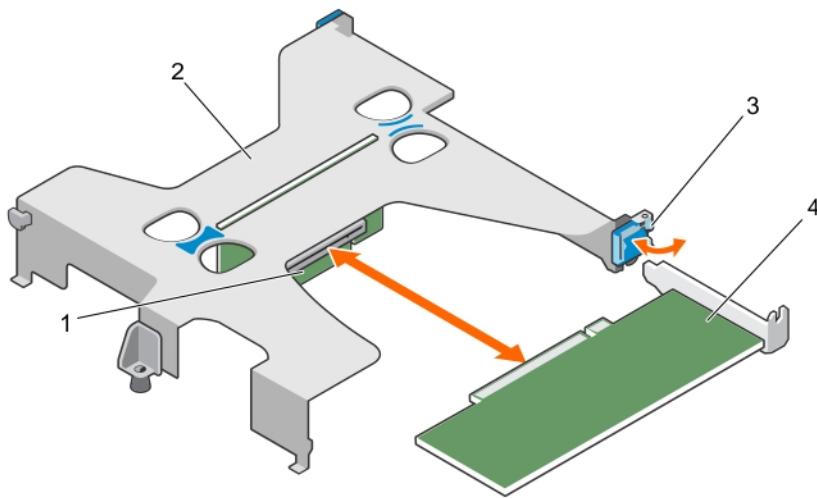

Figure 31. Removing and installing the expansion card from expansion-card riser

- | | |
|--|-------------------------|
| 1. expansion-card connector on the riser | 2. expansion-card riser |
| 3. expansion-card latch | 4. expansion card |

Next steps

Follow the procedure listed in [After working inside your system.](#)

Related Links

[Removing the expansion-card riser](#)

[Installing the expansion-card riser](#)

Installing an expansion card

Prerequisites

⚠ CAUTION: Many repairs may only be done by a certified service technician. You should only perform troubleshooting and simple repairs as authorized in your product documentation, or as directed by the online or telephone service and support team. Damage due to servicing that is not authorized by Dell is not covered by your warranty. Read and follow the safety instructions that came with the product.

1. Ensure that you read the [Safety instructions.](#)
2. Follow the procedure listed in [Before working inside your system.](#)

Steps

1. Locate the expansion-card connector on the riser.
2. Holding the card by its edges, position the card so that the card-edge connector aligns with the expansion-card connector.
3. Align the expansion-card bracket with the hooks on the chassis.
4. Insert the card-edge connector into the expansion-card connector until the card is fully seated.



NOTE: Ensure that the expansion card is properly seated along the chassis, so that expansion-card latch can be closed.

5. If applicable, connect cables to the expansion card.
6. Install the expansion card-riser on the system board.

Next steps

Follow the procedure listed in [After working inside your system](#).

Related Links

[Removing the expansion-card riser](#)

[Installing the expansion-card riser](#)

iDRAC ports card (optional)

The iDRAC ports card consists of the SD vFlash card slot and an iDRAC port. The iDRAC ports card is used for advanced management of the system.

An SD vFlash card is a Secure Digital (SD) card that plugs into the SD vFlash card slot in the system. It provides persistent on-demand local storage and a custom deployment environment that allows automation of server configuration, scripts, and imaging. It emulates USB device(s). For more information, see the Integrated Dell Remote Access Controller User's Guide at dell.com/esmmanuals.

Removing the iDRAC port card

Prerequisites



CAUTION: Many repairs may only be done by a certified service technician. You should only perform troubleshooting and simple repairs as authorized in your product documentation, or as directed by the online or telephone service and support team. Damage due to servicing that is not authorized by Dell is not covered by your warranty. Read and follow the safety instructions that came with the product.

1. Ensure that you read the [Safety instructions](#).
2. Follow the procedure listed in [Before working inside your system](#).
3. Disconnect any cables connected to the iDRAC port card.
4. If installed, remove the expansion-card riser.

Steps

1. Loosen the two screws securing the iDRAC port card holder to the system board.
2. Pull the iDRAC port card to disengage it from the connector and remove the card from the chassis.

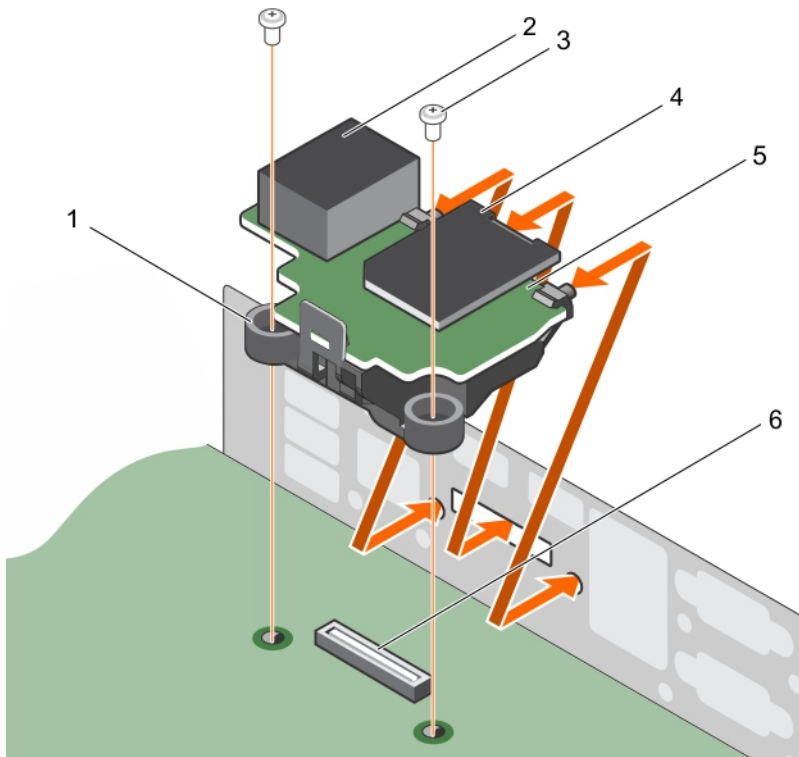

Figure 32. Removing and Installing the iDRAC port card

- | | |
|---------------------------|------------------------------|
| 1. iDRAC port card holder | 2. iDRAC port |
| 3. screw (2) | 4. SD vFlash media card |
| 5. iDRAC port card | 6. iDRAC port card connector |

Next steps

1. Install the expansion card, if applicable.
2. Install the expansion-card riser.
3. Follow the procedure listed in [After working inside your system](#).

Related Links

- [Removing the expansion-card riser](#)
- [Removing an expansion card](#)
- [Installing an expansion card](#)
- [Installing the expansion-card riser](#)

Installing the iDRAC port card

Prerequisites

 **CAUTION:** Many repairs may only be done by a certified service technician. You should only perform troubleshooting and simple repairs as authorized in your product documentation, or as directed by the online or telephone service and support team. Damage due to servicing that is not authorized by Dell is not covered by your warranty. Read and follow the safety instructions that came with the product.

1. Ensure that you read the [Safety instructions](#).
2. Follow the procedure listed in [Before working inside your system](#).
3. If installed, remove the expansion card and the expansion card riser.

Steps

1. Align and insert the tabs on the iDRAC port card on the slots on the chassis wall.
2. Insert the iDRAC port card into the connector on the system board.
3. Tighten the two screws that secure the iDRAC port card holder to the system board.
4. Reconnect the cable to the iDRAC port card.

Next steps

1. Install the expansion card, if applicable.
2. Install the expansion-card riser.
3. Follow the procedure listed in [After working inside your system](#).

Related Links

[Removing the expansion-card riser](#)

[Removing an expansion card](#)

[Installing an expansion card](#)

[Installing the expansion-card riser](#)

SD vFlash media card

A vFlash SD card is a Secure Digital (SD) card that plugs into the vFlash SD card slot in the system. It provides persistent on-demand local storage and a custom deployment environment that allows automation of server configuration, scripts, and imaging. It emulates USB device(s). For more information, see the Integrated Dell Remote Access Controller User's Guide at dell.com/esmmanuals.

Replacing an SD vFlash media card

1. Locate the SD vFlash media slot at the back of the chassis.
2. To remove the SD vFlash media card, push the card inward to release it, and pull the card from the card slot.

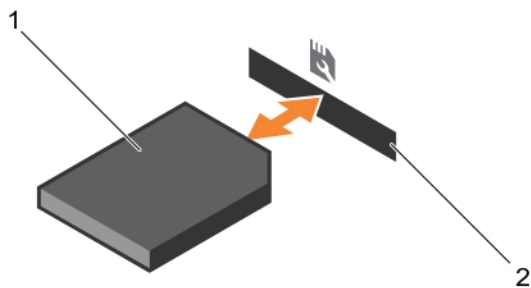



Figure 33. Removing and installing the SD vFlash media card

1. SD vFlash media card
 2. SD vFlash media-card slot
3. To install an SD vFlash media card, insert the contact-pin end of the SD vFlash media card into the card slot on the module.
 **NOTE:** The slot is keyed to ensure correct insertion of the card.
 4. Press the card inward to lock it into the slot.

Internal dual SD module

The Internal Dual SD Module (IDSDM) card provides two SD card slots. This card offers the following features:

- Dual card operation — maintains a mirrored configuration using SD cards in both slots and provides redundancy.
 **NOTE:** When the **Redundancy** option is set to **Mirror Mode** in the **Integrated Devices** screen of System Setup, the information is replicated from one SD card to another.
- Single card operation — single card operation is supported, but without redundancy.

Removing an internal SD card

Prerequisites

1. Ensure that you read the [Safety instructions](#).
2. Follow the procedure listed in [Before working inside your system](#).

 **CAUTION:** Many repairs may only be done by a certified service technician. You should only perform troubleshooting and simple repairs as authorized in your product documentation, or as directed by the online or telephone service and support team. Damage due to servicing that is not authorized by Dell is not covered by your warranty. Read and follow the safety instructions that came with the product.

Steps

Locate the SD card slot on the internal dual SD module and press the card to release it from the slot.

Next steps

Follow the procedure listed in [After working inside your system](#).

Installing an internal SD card

Prerequisites

1. Ensure that you read the [Safety instructions](#).
2. Follow the procedure listed in [Before working inside your system](#).

 **CAUTION:** Many repairs may only be done by a certified service technician. You should only perform troubleshooting and simple repairs as authorized in your product documentation, or as directed by the online or telephone service and support team. Damage due to servicing that is not authorized by Dell is not covered by your warranty. Read and follow the safety instructions that came with the product.

 **NOTE:** To use an SD card with your system, ensure that the **Internal SD Card Port** is enabled in the System Setup.

Steps

1. Locate the SD card connector on the internal dual SD module. Orient the SD card appropriately and insert the contact-pin end of the card into the slot.

 **NOTE:** The slot is keyed to ensure correct insertion of the card.

2. Press the card into the card slot to lock it into place.

Next steps

Follow the procedure listed in [After working inside your system](#).

Removing the internal dual SD module

Prerequisites

 **CAUTION:** Many repairs may only be done by a certified service technician. You should only perform troubleshooting and simple repairs as authorized in your product documentation, or as directed by the online or telephone service and support team. Damage due to servicing that is not authorized by Dell is not covered by your warranty. Read and follow the safety instructions that came with the product.

1. Ensure that you read the [Safety instructions](#).
2. Follow the procedure listed in [Before working inside your system](#).

Steps

1. Locate the internal dual SD module on the system board.
2. If installed, remove the SD card(s).
3. Hold the plastic pull tab and pull the dual SD module out of the system board.

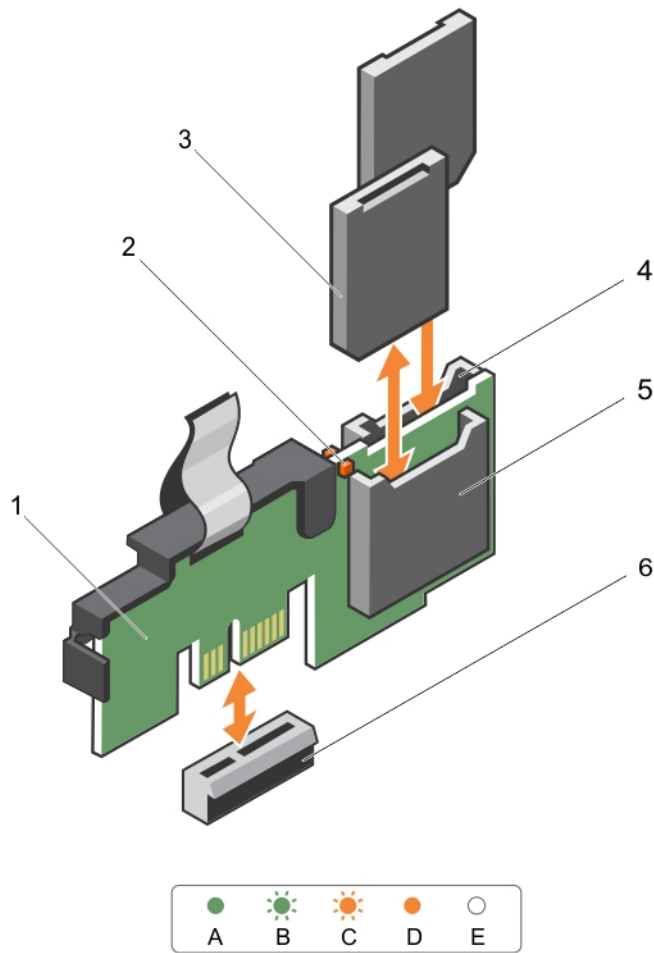

Figure 34. Removing and installing the Internal Dual SD Module (IDSDM)

- | | |
|----------------------------|-----------------------------|
| 1. Internal Dual SD module | 2. LED status indicator (2) |
| 3. SD card (2) | 4. SD card slot 2 |
| 5. SD card slot 1 | 6. IDSDM connector |

The following table describes the IDSDM indicator codes.

Convention	IDSDM indicator code	Description
A	Green	Indicates that the card is online
B	Flashing green	Indicates rebuild or activity
C	Flashing amber	Indicates card mismatch or that the card has failed
D	Amber	Indicates that the card is offline, has failed, or is write protected

Convention	IDSDM indicator code	Description
E	Not lit	Indicates that the card is missing or is booting

Next steps

Follow the procedure listed in [After working inside your system](#).

Installing the internal dual SD module

Prerequisites



CAUTION: Many repairs may only be done by a certified service technician. You should only perform troubleshooting and simple repairs as authorized in your product documentation, or as directed by the online or telephone service and support team. Damage due to servicing that is not authorized by Dell is not covered by your warranty. Read and follow the safety instructions that came with the product.

1. Ensure that you read the [Safety instructions](#).
2. Follow the procedure listed in [Before working inside your system](#).

Steps

1. Locate the IDSDM connector on the system board. To locate the IDSDM connector, see [System board connectors](#).
2. Align the connectors on the system board and the dual SD module.
3. Push the dual SD module until it is firmly seated on the system board.

Next steps

1. Install the SD vFlash media card(s).
 -  **NOTE:** Temporarily label each SD card with its corresponding slot before removal. Replace the SD card(s) into the same slots.
2. Follow the procedure listed in [After working inside your system](#).

Integrated storage controller card

Your system includes a dedicated expansion-card slot on the system board for an integrated controller card. The integrated storage controller card provides the integrated storage subsystem for your system's internal hard drives. The controller supports SAS and SATA hard drives and also enables you to set up the hard drives in RAID configurations as supported by the version of the storage controller included with your system.

Removing the integrated storage controller card

Prerequisites

1. Ensure that you read the [Safety instructions](#).
2. Follow the procedure listed in [Before working inside your system](#).
3. Remove the cooling shroud.
4. Keep the #2 Phillips screwdriver handy.

CAUTION: Many repairs may only be done by a certified service technician. You should only perform troubleshooting and simple repairs as authorized in your product documentation, or as directed by the online or telephone service and support team. Damage due to servicing that is not authorized by Dell is not covered by your warranty. Read and follow the safety instructions that came with the product.

Steps

1. Loosen the screws that secure the integrated storage controller cable to the integrated storage-controller card connector on the system board.
2. Lift the integrated storage controller cable out.
3. Lift one end of the card and angle it to disengage the card from the integrated storage-controller card holder on system board.
4. Lift the card out of the chassis.

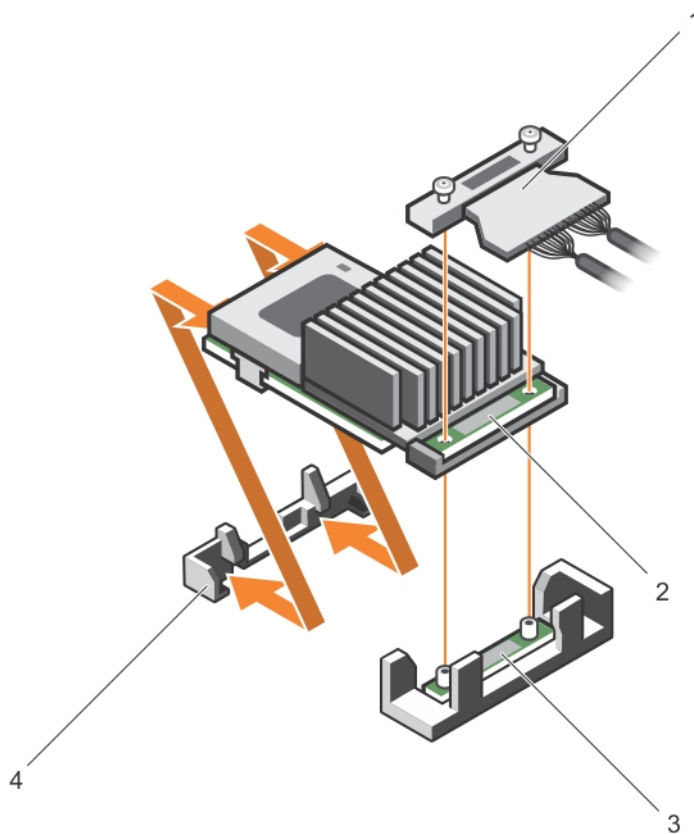

Figure 35. Removing and installing the integrated storage controller card

- | | |
|---|--|
| 1. integrated storage controller cable | 2. integrated storage controller card |
| 3. integrated storage-controller card connector on the system board | 4. integrated storage controller card holder |

Next steps

1. Replace the cooling shroud.

2. Follow the procedure listed in [After working inside your system](#).

Related Links

[Removing the cooling shroud](#)

[Installing the cooling shroud](#)

Installing the integrated storage controller card

Prerequisites

 **CAUTION:** Many repairs may only be done by a certified service technician. You should only perform troubleshooting and simple repairs as authorized in your product documentation, or as directed by the online or telephone service and support team. Damage due to servicing that is not authorized by Dell is not covered by your warranty. Read and follow the safety instructions that came with the product.

1. Ensure that you read the [Safety instructions](#).
2. Follow the procedure listed in [Before working inside your system](#).
3. Remove the cooling shroud.
4. Keep the #2 Phillips screwdriver ready.

Steps

1. Align the end of the integrated storage-controller card with the integrated storage-controller card holder.
2. Lower the connector side of the integrated storage-controller card into the integrated storage-controller card connector on the system board.
Ensure that the tabs on the system board align with the screw holes on the integrated storage-controller card.
3. Align the screws on the integrated storage-controller card cable with the screw holes on the connector.
4. Tighten the screws to secure the integrated storage-controller card cable with the integrated storage-controller card connector on the system board.

Next steps

1. Replace the cooling shroud.
2. Follow the procedure listed in [After working inside your system](#).

Related Links

[Removing the cooling shroud](#)

[Installing the cooling shroud](#)

Heat sinks and processors





Use the following procedure when:

- Installing an additional processor
- Replacing a processor

 **NOTE:** To ensure proper system cooling, you must install a processor blank in any empty processor socket.

Removing a processor

Prerequisites

-  **WARNING:** The heat sink and processor are hot to the touch for some time after the system has been powered down. Allow the heat sink and processor to cool before handling them.
 -  **CAUTION:** Many repairs may only be done by a certified service technician. You should only perform troubleshooting and simple repairs as authorized in your product documentation, or as directed by the online or telephone service and support team. Damage due to servicing that is not authorized by Dell is not covered by your warranty. Read and follow the safety instructions that came with the product.
 -  **CAUTION:** Never remove the heat sink from a processor unless you intend to remove the processor. The heat sink is necessary to maintain proper thermal conditions.
1. Ensure that you read the [Safety instructions](#).
 2. Keep the #2 Phillips screwdriver handy.
 3. Before upgrading your system, download the latest system BIOS version from dell.com/support and follow the instructions included in the compressed download file to install the update on your system.
 -  **NOTE:** You can update the system BIOS using the Lifecycle Controller. For more information about Dell Lifecycle controller, see dell.com/esmmanuals.
 4. Follow the procedure listed in [Before working inside your system](#).
 5. Remove the cooling shroud.

Steps

1. Loosen one of the screws that secures the heat sink to the system board.
Wait 30 seconds for the heat sink to loosen from the processor.
2. Remove the screw diagonally opposite the screw you first removed.
3. Repeat the procedure for the remaining two screws.
4. Remove the heat sink.

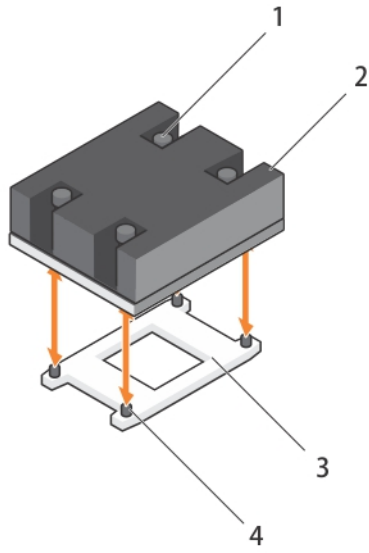

Figure 36. Removing and installing a processor heat sink

- | | |
|----------------------|--------------|
| 1. captive screw (4) | 2. heat sink |
| 3. processor socket | 4. slot (4) |

⚠ CAUTION: The processor is held in its socket under strong pressure. Be aware that the release lever can spring up suddenly if not firmly grasped.

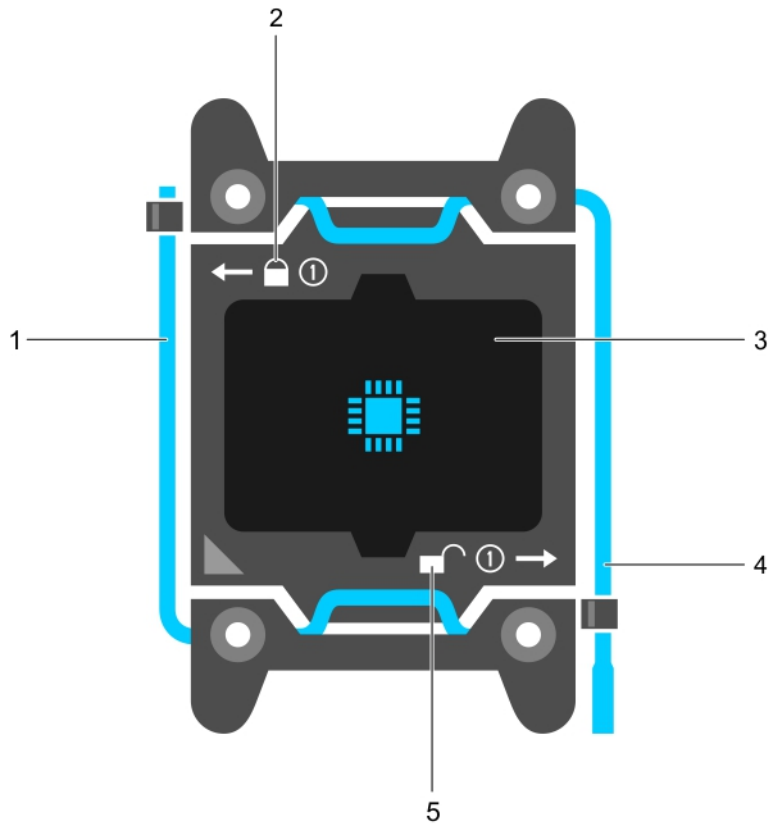



Figure 37. Processor shield opening and closing lever sequence

- | | |
|--|---|
| 1. <i>close first</i> socket release lever | 2. lock icon |
| 3. processor | 4. <i>open first</i> socket release lever |
| 5. unlock icon | |
5. Position your thumb firmly over the processor *open first* socket-release lever near the unlock icon  and release the lever from the locked position by pushing down and out from under the tab.
 6. Similarly, position your thumb firmly over the processor *close first* socket-release lever near the lock icon  and release the lever from the locked position by pushing down and out from under the tab. Rotate the lever 90 degrees upward.
 7. Lower the *open first* socket-release lever to lift the processor shield.

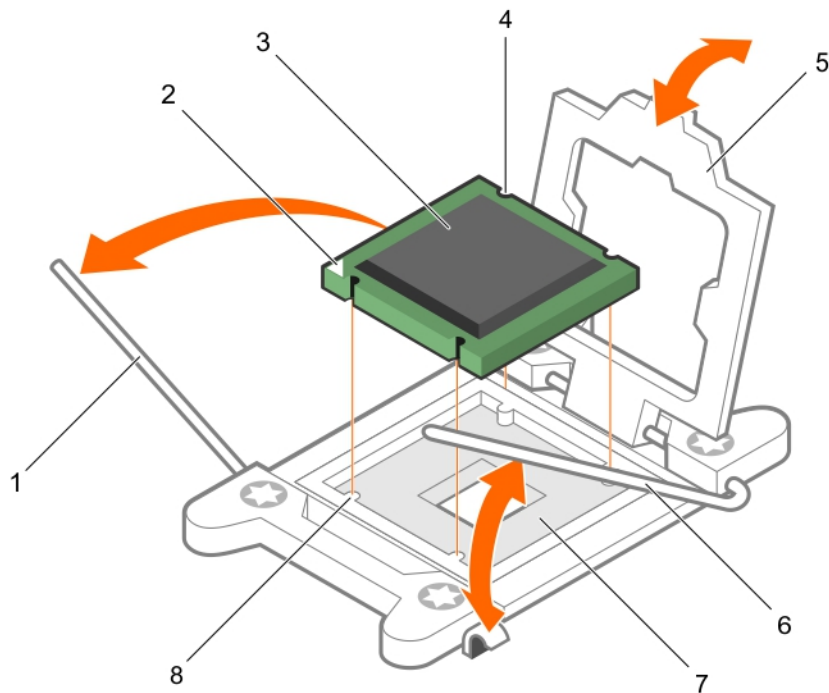

Figure 38. Removing and installing a processor

- | | |
|-------------------------------------|------------------------------------|
| 1. close first socket-release lever | 2. pin-1 indicator of processor |
| 3. processor | 4. slot (4) |
| 5. processor shield | 6. open first socket-release lever |
| 7. socket | 8. socket keys (4) |
8. Hold the tab on the processor shield and rotate the processor shield upward until the *open first* socket-release lever lifts up.
 9. Lift the processor out of the socket and leave the *open first* socket-release lever up so that the socket is ready for the new processor.

CAUTION: The socket pins are fragile and can be permanently damaged. Be careful not to bend the pins in the socket when removing the processor out of the socket.

NOTE: If you are permanently removing the processor, you must install a socket protective cap in the vacant socket to protect the socket pins and keep the socket free of dust.

NOTE: After removing the processor, place it in an antistatic container for reuse, return, or temporary storage. Do not touch the bottom of the processor. Touch only the side edges of the processor.

Related Links

[Removing the cooling shroud](#)

[Installing the cooling shroud](#)

Installing a processor

Prerequisites

1. Ensure that you read the [Safety instructions](#).
2. Keep the #2 Phillips screwdriver handy.
3. Before upgrading your system, download the latest system BIOS version from [dell.com/support](https://www.dell.com/support) and follow the instructions included in the compressed download file to install the update on your system.

 **NOTE:** You can update the system BIOS using the Lifecycle Controller.

4. Follow the procedure listed in [Before working inside your system](#).
5. Remove the cooling shroud.



 **WARNING:** The heat sink and processor are hot to the touch for some time after the system has been powered down. Allow the heat sink and processor to cool before handling them.

 **CAUTION:** Never remove the heat sink from a processor unless you intend to remove the processor. The heat sink is necessary to maintain proper thermal conditions.

 **CAUTION:** Many repairs may only be done by a certified service technician. You should only perform troubleshooting and simple repairs as authorized in your product documentation, or as directed by the online or telephone service and support team. Damage due to servicing that is not authorized by Dell is not covered by your warranty. Read and follow the safety instructions that came with the product.

 **NOTE:** If you are installing a single processor, it must be installed in socket CPU1.

Steps

1. Remove the heat sink.
2. Unpack the new processor
If the processor has previously been used in a system, remove any remaining thermal grease from the processor using a lint-free cloth.
3. Locate the processor socket.
4. If applicable, remove the socket protective cap.
5. Position your thumb firmly over the *open first* socket-release lever near the unlock icon  and release the lever from the locked position by pushing down and in from under the tab.
6. Similarly, release the *close first* socket-release lever near the lock icon  from the locked position. Rotate the lever 90 degrees upward.
7. Hold the tab near the lock symbol on the processor shield and rotate it upward and out of the way.
8. To install the processor in the socket:

 **CAUTION:** Positioning the processor incorrectly can permanently damage the system board or the processor. Be careful not to bend the pins in the socket.



 **CAUTION:** While removing or reinstalling the processor, wipe your hands of any contaminants. Contaminants on the processor pins such as thermal grease or oil can damage the processor.

- a. Align the processor with the socket keys on the socket.

△ CAUTION: Do not use force to seat the processor. When the processor is positioned correctly, it engages easily into the socket.

- b. Align the pin-1 indicator of the processor with the triangle on the socket.
- c. Place the processor on the socket such that the slots on the processor aligns with the socket keys on the socket.

△ CAUTION: Do not use force to seat the processor. When the processor is positioned correctly, it engages easily into the socket.

- d. Close the processor shield.
 - e. Rotate the *close first* socket-release lever near the lock icon  until it is locked in position.
 - f. Similarly, rotate the *open first* socket-release lever near the unlock icon  to the unlocked position.
9. To install the heat sink:
- a. If applicable, remove the existing thermal grease from the heat sink using a clean lint-free cloth.
 - b. Apply thermal grease on the top of the processor. Use the thermal-grease syringe included with your processor kit to apply the grease in a thin spiral on the top of the processor as shown in the figure.

△ CAUTION: Applying too much thermal grease can result in excess grease coming in contact with and contaminating the processor socket.

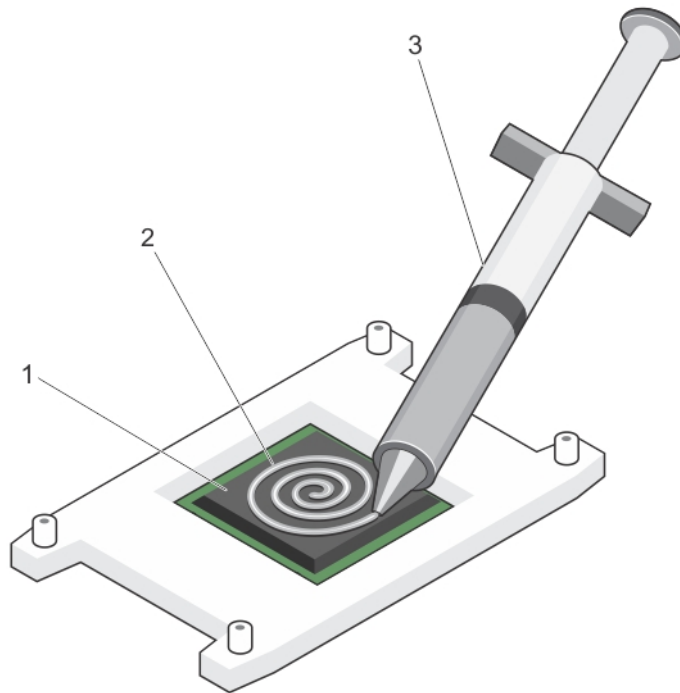



Figure 39. Applying thermal grease on the top of the processor

1. processor

2. thermal grease

3. thermal-grease syringe

 **NOTE:** The thermal-grease is intended for one-time use only. Dispose of the syringe after you use it.

- c. Place the heat sink onto the processor.
- d. Tighten the four screws to secure the heat sink to the system board.

 **NOTE:** Tighten the screws diagonally opposite to each other. Do not over-tighten the heat sink retention screws when installing the heat sink. To prevent over-tightening, tighten the retention screw until resistance is felt, and stop once the screw is seated. The screw tension should be no more than 6 in-lb (6.9 kg-cm).

Next steps

1. Install the cooling shroud.
2. Follow the procedure listed in [After working inside your system](#).
3. While booting, press <F2> to enter the System Setup and check that the processor information matches the new system configuration.
4. Run the system diagnostics to verify that the new processor operates correctly.

Related Links

[Removing the cooling shroud](#)

[Installing the cooling shroud](#)

Power supplies

Your system supports the following power supplies:

- 450 W AC (non-redundant)
- 550 W AC (redundant)

When two identical power supplies are installed, the power supply configuration is redundant (1 + 1). In redundant mode, power is supplied to the system equally from both power supplies to maximize efficiency.

When only one power supply is installed, the power supply configuration is non-redundant (1 + 0). Power is supplied to the system only by the single power supply.

 **NOTE:** If two power supplies are used, they must be of the same type and have the same maximum output power.

 **NOTE:** For AC power supplies, use only PSUs with the Extended Power Performance (EPP) label on the back. Mixing PSUs from previous generations of Dell PowerEdge servers can result in a PSU mismatch condition or failure to power on.

Hot Spare feature

Your system supports the Hot Spare feature that significantly reduces the power overhead associated with power supply redundancy.

When the Hot Spare feature is enabled, one of the redundant power supplies is switched to a sleep state. The active power supply supports 100% of the load, thus operating at higher efficiency. The power supply

in the sleep state monitors output voltage of the active power supply. If the output voltage of the active power supply drops, the power supply in the sleep state returns to an active output state.

If having both power supplies active is more efficient than having one power supply in a sleep state, the active power supply can also activate a sleeping power supply.

The default power supply settings are as follows:

- If the load on the active power supply is more than 50%, then the redundant power supply is switched to the active state.
- If the load on the active power supply falls below 20%, then the redundant power supply is switched to the sleep state

You can configure the Hot Spare feature using the iDRAC settings. For more information on iDRAC settings, see the Integrated Dell Remote Access Controller User's Guide at dell.com/support/home.

Removing a redundant power supply

Prerequisites

 **CAUTION:** Many repairs may only be done by a certified service technician. You should only perform troubleshooting and simple repairs as authorized in your product documentation, or as directed by the online or telephone service and support team. Damage due to servicing that is not authorized by Dell is not covered by your warranty. Read and follow the safety instructions that came with the product.

 **CAUTION:** The system requires one power supply for normal operation. On power-redundant systems, remove and replace only one power supply at a time in a system that is powered on.

1. Ensure that you read the [Safety instructions](#).
2. Disconnect the power cable from the power source.
3. Disconnect the power cable from the power supply and remove the straps that bundle and secure the system cables.

 **NOTE:** You may have to unlatch and lift the optional cable management arm if it interferes with power-supply removal. For information about the cable management arm, see the system's rack documentation.

Steps

Press the release latch and pull the power supply straight out to release it from the power interposer board and clear the chassis.

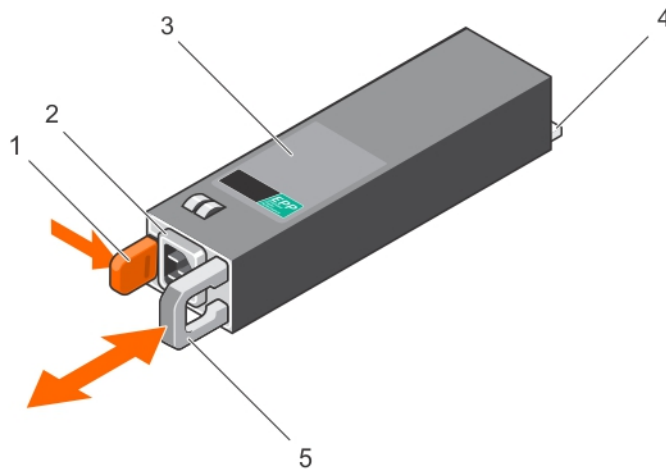

Figure 40. Removing and installing a redundant power supply

- | | |
|--------------------------------|---------------------------|
| 1. release latch | 2. power supply connector |
| 3. redundant power supply unit | 4. connector |
| 5. power supply handle | |

Installing a redundant power supply

Prerequisites

⚠ CAUTION: Many repairs may only be done by a certified service technician. You should only perform troubleshooting and simple repairs as authorized in your product documentation, or as directed by the online or telephone service and support team. Damage due to servicing that is not authorized by Dell is not covered by your warranty. Read and follow the safety instructions that came with the product.

Ensure that you read the [Safety instructions](#).

Steps

1. Verify that both power supplies are the same type and have the same maximum output power.
 - ✎ NOTE:** The maximum output power (shown in Watts) is listed on the power supply label.
2. If applicable, remove the power supply blank.
3. Slide the new power supply into the chassis until the power supply is fully seated and the release latch snaps into place.
 - ✎ NOTE:** If you unlatched the cable management arm in step 3 of the previous procedure, relatch it. For information about the cable management arm, see the system's rack documentation.
4. Connect the power cable to the power supply and plug the cable into a power outlet.
 - ⚠ CAUTION:** When connecting the power cable, secure the cable with the strap.

-  **NOTE:** When installing, hot-swapping, or hot-adding a new power supply in a system with two power supplies, allow several seconds for the system to recognize the power supply and determine its status. The power-supply status indicator turns green to signify that the power supply is functioning properly.

Removing a non-redundant power supply

Prerequisites

 **CAUTION:** Many repairs may only be done by a certified service technician. You should only perform troubleshooting and simple repairs as authorized in your product documentation, or as directed by the online or telephone service and support team. Damage due to servicing that is not authorized by Dell is not covered by your warranty. Read and follow the safety instructions that came with the product.

1. Ensure that you read the [Safety instructions](#).
2. Disconnect the power cable from the power source.
3. Disconnect the power cable from the power supply and remove the straps that bundle and secure the system cables.
4. Follow the procedure listed in [Before working inside your system](#).

 **NOTE:** You may have to unlatch and lift the optional cable management arm if it interferes with the power-supply removal. For information about the cable management arm, see the system's rack documentation.

Steps

1. Disconnect all the power cables from the power supply to the system board, hard drives, and optical drive.
2. Remove the screw securing the power supply to the chassis, slide and lift the power supply out of the chassis.

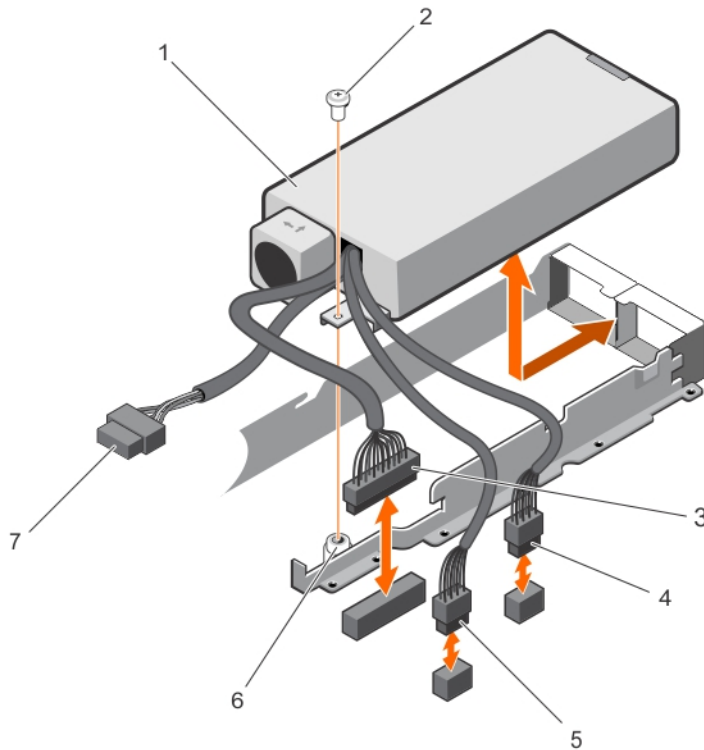

Figure 41. Removing and installing a non-redundant power supply

- | | |
|------------------------|-----------------------|
| 1. power supply | 2. screw |
| 3. P1 cable connector | 4. P2 cable connector |
| 5. P3 cable connector | 6. standoff |
| 7. Backplane connector | |

Installing a non-redundant power supply

Prerequisites

CAUTION: Many repairs may only be done by a certified service technician. You should only perform troubleshooting and simple repairs as authorized in your product documentation, or as directed by the online or telephone service and support team. Damage due to servicing that is not authorized by Dell is not covered by your warranty. Read and follow the safety instructions that came with the product.

1. Ensure that you read the [Safety instructions](#).
2. Follow the procedure listed in [Before working inside your system](#).

NOTE: A hot-swappable non-redundant power supply must be installed in Slot 1 of the power supply bay.

Steps

1. Align the screw hole on the power supply with the standoff on the chassis.
2. Tighten the screw to secure the power supply to the chassis.
3. Connect all the power cables to the system board, hard drives, and optical drive.

Next steps

1. Follow the procedure listed in [After working inside your system](#).
2. Connect the power cable to the power supply and plug the cable into a power outlet.

Removing the power supply unit blank

If you are installing a second power supply unit, remove the power supply unit blank in the bay by pulling the blank outward.

⚠ CAUTION: To ensure proper system cooling, the power supply blank must be installed in the second power supply bay in a non-redundant configuration. Remove the power supply blank only if you are installing a second power supply.

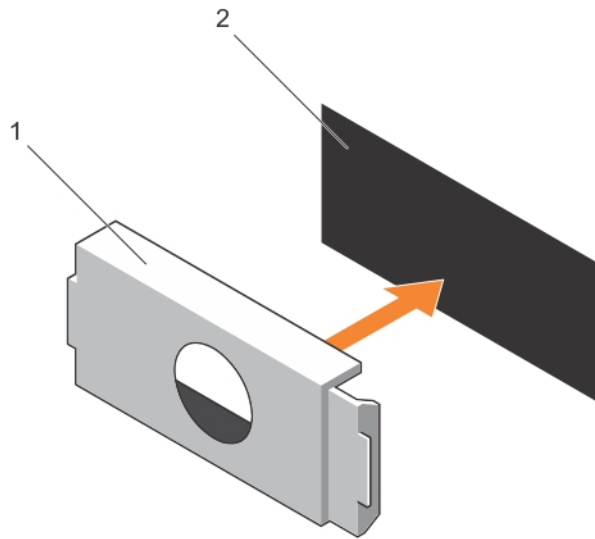

Figure 42. Removing and installing the power supply blank

1. power supply blank
2. power supply bay

Installing the power supply unit blank

Install the power supply unit blank only in the second power supply unit bay.

To install the power supply unit blank, align the blank with the power supply unit bay and push it into the chassis until it clicks into place.

System battery

Replacing the system battery

Prerequisites

⚠ WARNING: There is a danger of a new battery exploding if it is incorrectly installed. Replace the battery only with the same or equivalent type recommended by the manufacturer. See your safety information for additional information.

△ CAUTION: Many repairs may only be done by a certified service technician. You should only perform troubleshooting and simple repairs as authorized in your product documentation, or as directed by the online or telephone service and support team. Damage due to servicing that is not authorized by Dell is not covered by your warranty. Read and follow the safety instructions that came with the product.

1. Ensure that you read the [Safety instructions](#).
2. Follow the procedure listed in [Before working inside your system](#).
3. Remove the expansion-card riser.

Steps

1. Locate the battery socket, see [System board connectors](#).

△ CAUTION: To avoid damage to the battery connector, you must firmly support the connector while installing or removing a battery.

2. To eject the battery, press firmly on the edge of the positive side of the battery in the direction of the arrow as shown in the illustration below.

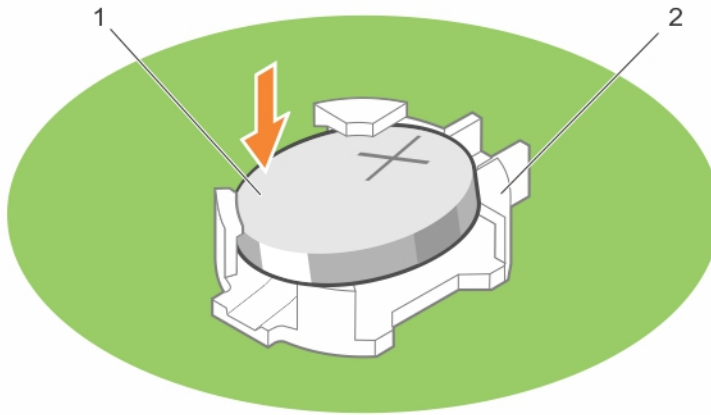

1. positive side of battery

2. socket

3. To install a new system battery, hold the battery with the positive facing up and slide it under the securing tabs.
4. Press the battery into the connector until it snaps into place.

Next steps

1. Install the expansion-card riser.
2. Follow the procedure listed in [After working inside your system](#).
3. While booting, press <F2> to enter the System Setup and ensure the battery is operating properly.
4. Enter the correct time and date in the System Setup **Time** and **Date** fields.
5. Exit the System Setup.

Related Links

[Removing the expansion-card riser](#)

[Removing an expansion card](#)

[Installing an expansion card](#)
[Installing the expansion-card riser](#)



Hard-drive backplane

Depending on your system configuration:

PowerEdge	3.5 inch or 2.5 inch (x4) SAS/SATA backplane or
R430 supports	2.5 inch (x8) SAS/SATA backplane or
	2.5 inch (x10) SAS/SATA backplane

Removing the hard-drive backplane

Prerequisites

-  **CAUTION:** Many repairs may only be done by a certified service technician. You should only perform troubleshooting and simple repairs as authorized in your product documentation, or as directed by the online or telephone service and support team. Damage due to servicing that is not authorized by Dell is not covered by your warranty. Read and follow the safety instructions that came with the product.
-  **CAUTION:** To prevent damage to the drives and backplane, you must remove the hard drives from the system before removing the backplane.
-  **CAUTION:** You must note the number of each hard drive and temporarily label them before removal so that you can replace them in the same locations.

1. Ensure that you read the [Safety instructions](#).
2. Follow the procedure listed in [Before working inside your system](#).
3. Remove all hard drives.

Steps

1. Disconnect the SAS/SATA data, signal, and power cable(s) from the backplane.
2. Press the release tabs and lift the backplane upward and slide it toward the back of the chassis.

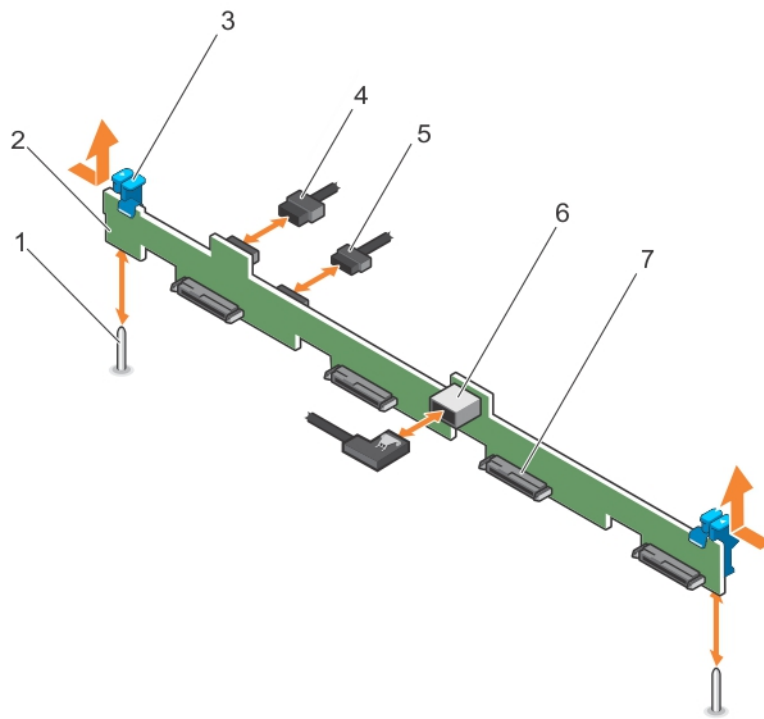

Figure 43. Removing and Installing the 3.5 inch or 2.5 inch (x4) SAS/SATA backplane

- | | |
|---------------------------------|-------------------------------------|
| 1. guide (2) | 2. hard-drive/SSD backplane |
| 3. release tab (2) | 4. backplane power cable |
| 5. backplane signal cable | 6. SAS_A connector on the backplane |
| 7. hard-drive/SSD connector (4) | |

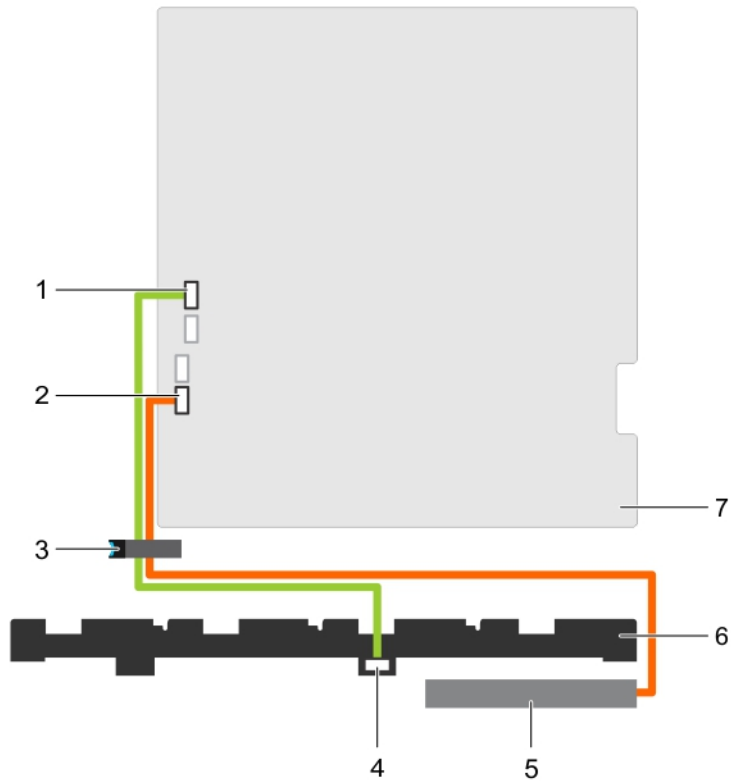

Figure 44. Cabling diagram—3.5 inch or 2.5 inch (x4) SAS/SATA backplane

- | | |
|--|---|
| 1. SW_RAID_A connector on the system board | 2. SATA_CDROM connector on the system board |
| 3. cable routing latch | 4. SAS_A connector on the backplane |
| 5. Optical Disk Drive (ODD) | 6. hard-drive backplane |
| 7. system board | |

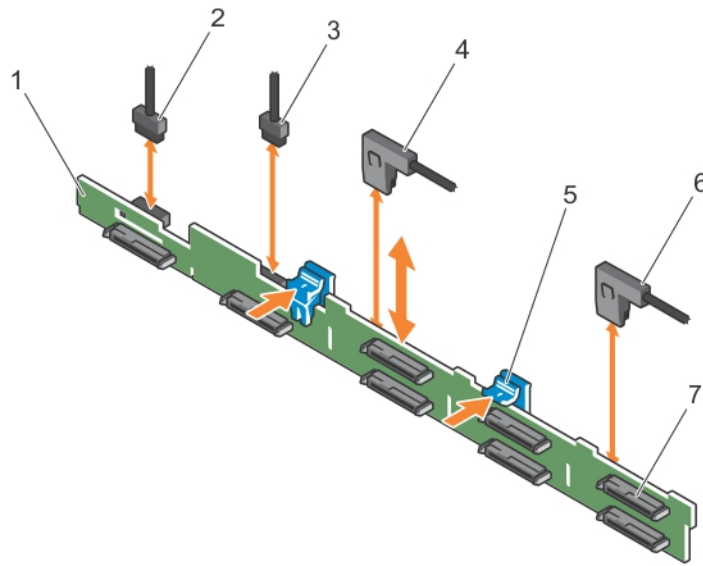

Figure 45. Removing and installing the 2.5 inch (x8) SAS/SATA backplane

- | | |
|---------------------------------|--------------------------|
| 1. hard-drive/SSD backplane | 2. backplane power cable |
| 3. backplane signal cable | 4. SAS_A cable connector |
| 5. release tab (2) | 6. SAS_B cable connector |
| 7. hard-drive/SSD connector (8) | |

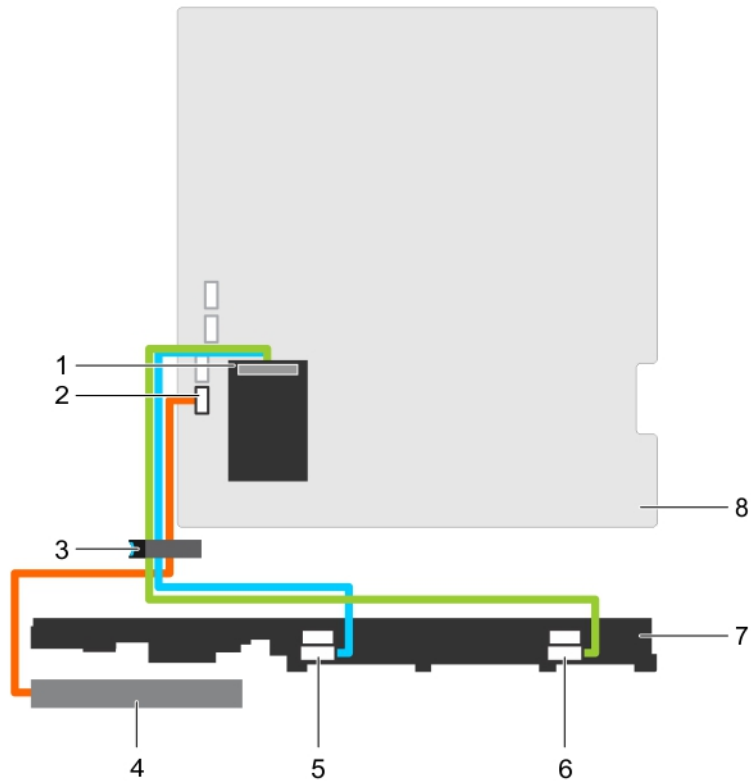

Figure 46. Cabling diagram—2.5 inch (x8) SAS/SATA backplane

- | | |
|---------------------------------------|---|
| 1. integrated storage controller card | 2. SATA_CDROM connector on the system board |
| 3. cable routing latch | 4. Optical Disk Drive (ODD) |
| 5. SAS_A connector on the backplane | 6. SAS_B connector on the backplane |
| 7. hard-drive/SSD backplane | 8. system board |

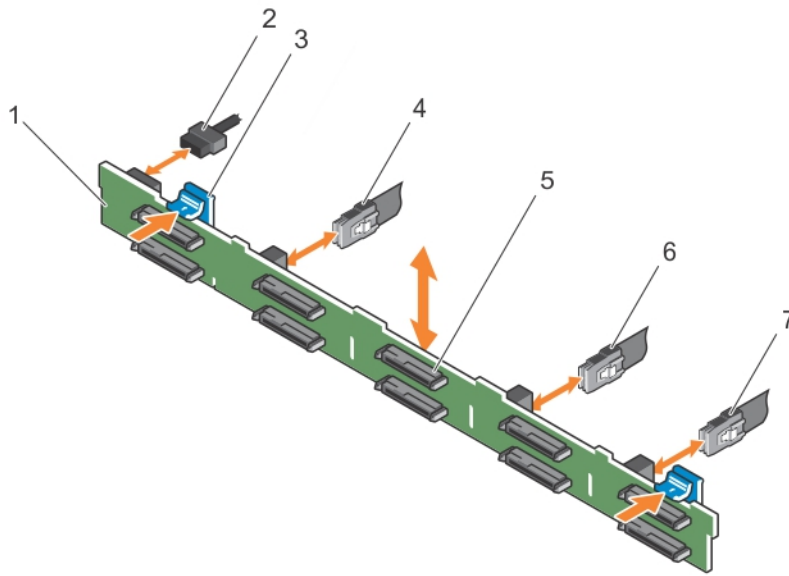

Figure 47. Removing and installing the 2.5 inch (x10) SAS/SATA backplane

- | | |
|-------------------------------------|-------------------------------------|
| 1. hard drive/SSD backplane | 2. backplane power cable |
| 3. release tab (2) | 4. SAS_A connector on the backplane |
| 5. hard drive/SSD connector (10) | 6. SAS_B connector on the backplane |
| 7. SAS_C connector on the backplane | |

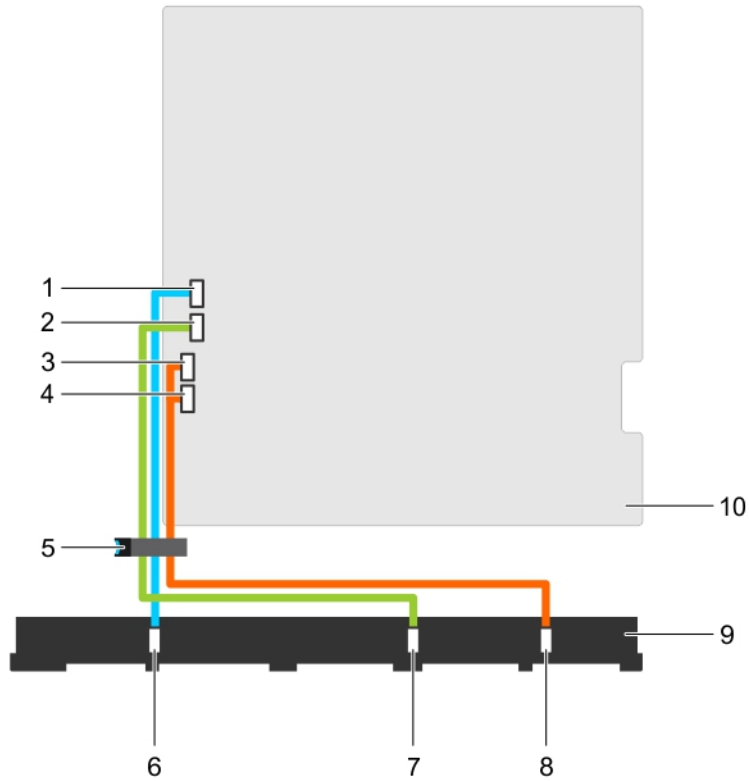

Figure 48. Cabling diagram—2.5 inch (x10) SAS/SATA backplane

- | | |
|--|--|
| 1. SW_RAID_A connector on the system board | 2. SW_RAID_B connector on the system board |
| 3. SATA_HDD8 connector on the system board | 4. SATA_HDD9 connector on the system board |
| 5. cable routing latch | 6. SAS_A connector on the backplane |
| 7. SAS_B connector on the backplane | 8. SAS_C connector on the backplane |
| 9. hard drive/SSD backplane | 10. system board |

Related Links

[Removing a hot-swap hard drive](#)

Installing the hard-drive backplane

Prerequisites

 **CAUTION:** Many repairs may only be done by a certified service technician. You should only perform troubleshooting and simple repairs as authorized in your product documentation, or as directed by the online or telephone service and support team. Damage due to servicing that is not authorized by Dell is not covered by your warranty. Read and follow the safety instructions that came with the product.

 **CAUTION:** To prevent damage to the control panel flex cable, do not to bend the control panel flex cable after it is inserted into the connector.

1. Ensure that you read the [Safety instructions](#).
2. Follow the procedure listed in [Before working inside your system](#).

Steps

1. Use the hooks on the chassis as guides to align the hard-drive backplane.
2. Slide down the hard-drive backplane until the release tabs snap into place.
3. Connect the SAS/SATA/SSD data, signal, and power cable(s) to the backplane.

Next steps

1. Install the hard drives in their original locations.
2. Follow the procedure listed in [After working inside your system](#).

Related Links

[Installing a hot-swap hard drive](#)

Control-panel assembly

Removing the control panel

Prerequisites

 **CAUTION:** Many repairs may only be done by a certified service technician. You should only perform troubleshooting and simple repairs as authorized in your product documentation, or as directed by the online or telephone service and support team. Damage due to servicing that is not authorized by Dell is not covered by your warranty. Read and follow the safety instructions that came with the product.

1. Ensure that you read the [Safety instructions](#).
2. Follow the procedure listed in [Before working inside your system](#).
3. Keep the #2 Phillips screwdriver handy.

Steps

1. Using a #2 Phillips screwdriver, remove the screw(s) securing the control panel to the chassis.

 **CAUTION:** Do not use excessive force when removing the control panel as it can damage the connectors.

2. Release the locking tabs of the control panel by angling the control panel up and away from the system.

For an eight 2.5 inch hot-swappable hard-drive chassis, remove the screw (located at the bottom of the chassis) that secures the control panel to the chassis.

For a ten 2.5 inch hot-swappable hard-drive chassis, Press the control panel latch and slide the control panel out of the chassis.

3. Remove all the cables connecting the control panel to the chassis.

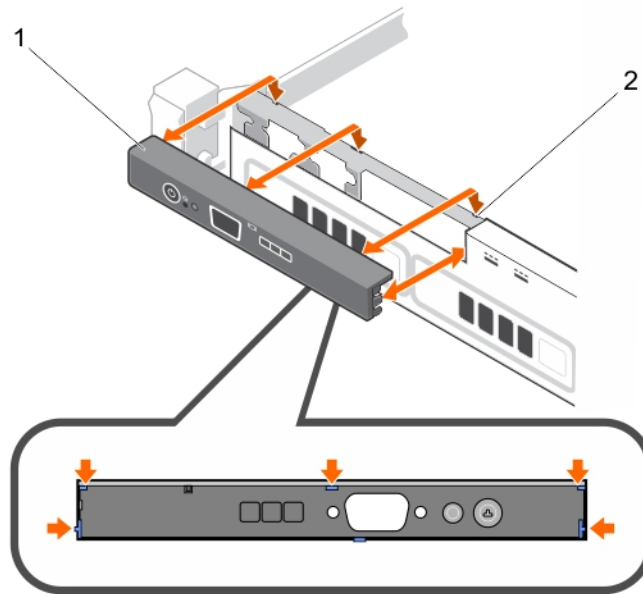

Figure 49. Removing and installing the control panel—four 3.5 inch hard-drives chassis

1. control panel

2. notches (6)

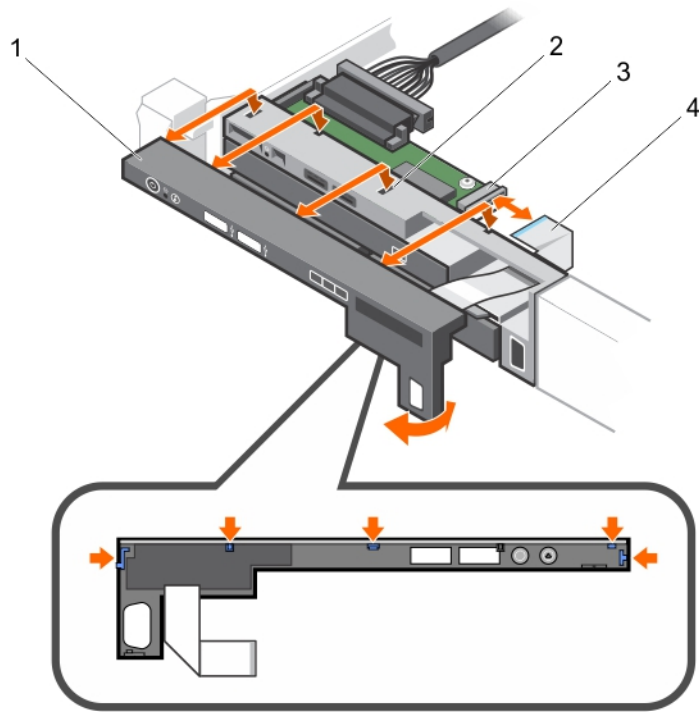

Figure 50. Removing and installing the control panel—eight 2.5 inch hard-drives/SSDs chassis

- | | |
|-------------------------|------------------------|
| 1. control panel | 2. notches (4) |
| 3. control panel module | 4. LCD connector cable |

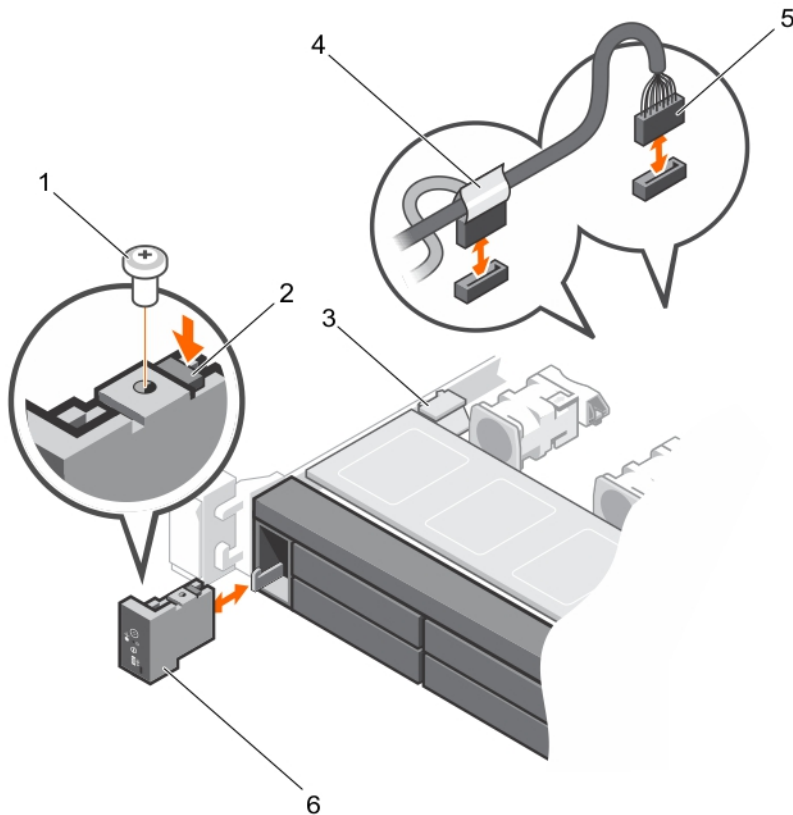

Figure 51. Removing and installing the control panel—ten 2.5 inch hard-drives/SSDs chassis

- | | |
|-----------------------------|---|
| 1. screw | 2. control panel release latch |
| 3. cable securing clip | 4. control panel cable connecting to the system board |
| 5. J_FP_USB connector cable | 6. control panel |

Next steps

1. Replace the control panel.
2. Follow the procedure listed in [After working inside your system.](#)

Related Links

[Installing the control panel](#)

Installing the control panel

Prerequisites

⚠ CAUTION: Many repairs may only be done by a certified service technician. You should only perform troubleshooting and simple repairs as authorized in your product documentation, or as directed by the online or telephone service and support team. Damage due to servicing that is not authorized by Dell is not covered by your warranty. Read and follow the safety instructions that came with the product.

1. Ensure that you read the [Safety instructions](#).
2. Keep the #2 Phillips screwdriver handy.

Steps

Align the locking tabs on the control panel with the notches on the chassis and angle the control panel until it snaps into place.

When properly seated, the control panel will be flush with the front panel.

 **NOTE:** For an eight 2.5 inch hard drive chassis, tighten the screw to secure the control panel to the bottom of the chassis.

 **NOTE:** For a ten 2.5 inch hard-drive chassis, slide the control panel into the chassis and secure the module with the screw.

Next steps

Follow the procedure listed in [After working inside your system](#).

Removing the control-panel module

Prerequisites

 **CAUTION:** Many repairs may only be done by a certified service technician. You should only perform troubleshooting and simple repairs as authorized in your product documentation, or as directed by the online or telephone service and support team. Damage due to servicing that is not authorized by Dell is not covered by your warranty. Read and follow the safety instructions that came with the product.

1. Ensure that you read the [Safety instructions](#).
2. Follow the procedure listed in [Before working inside your system](#).

 **CAUTION:** Do not use excessive force when removing the control panel as it can damage the connectors.

Steps

1. Remove the screw(s) securing the control-panel module to the chassis.
2. For a 3.5 inch cabled hard-drive chassis:
 - a. Remove the screw(s) securing the LED panel to the chassis.
 - b. Remove the LED panel.
3. Remove all the cables connecting the control-panel module to the chassis.

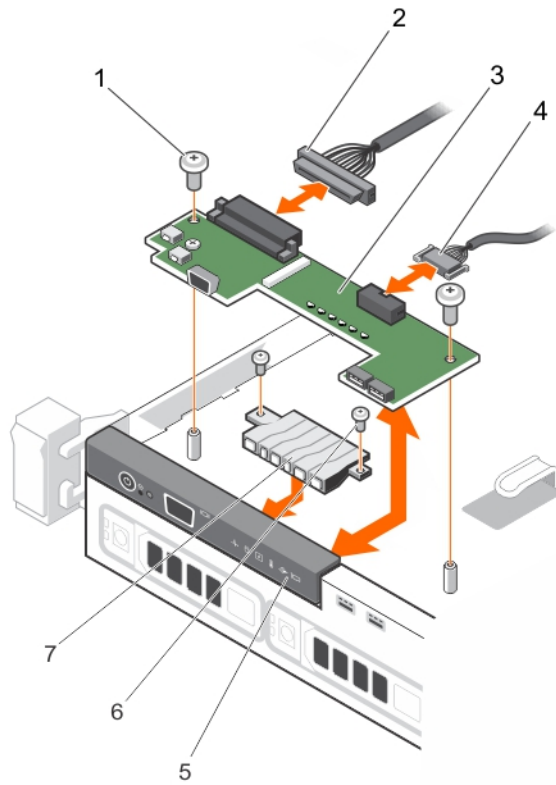

Figure 52. Removing and installing the control-panel module—four cabled hard-drive chassis

- | | |
|-------------------------|---|
| 1. screw (2) | 2. control-panel module connector cable |
| 3. control panel module | 4. USB connector cable |
| 5. control panel | 6. LED-panel screw (2) |
| 7. LED panel | |

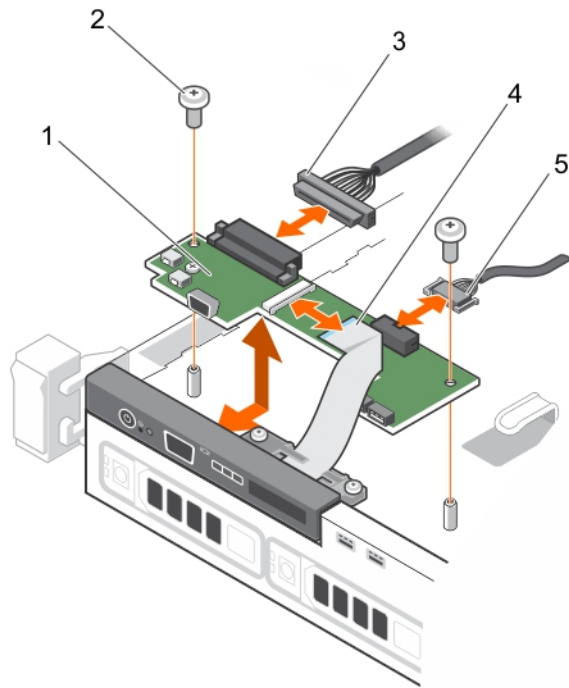

Figure 53. Removing and installing the control panel module—four hard-drive chassis

- | | |
|---|------------------------------------|
| 1. control-panel module | 2. control-panel module screws (2) |
| 3. control-panel module connector cable | 4. display module cable |
| 5. USB connector cable | |

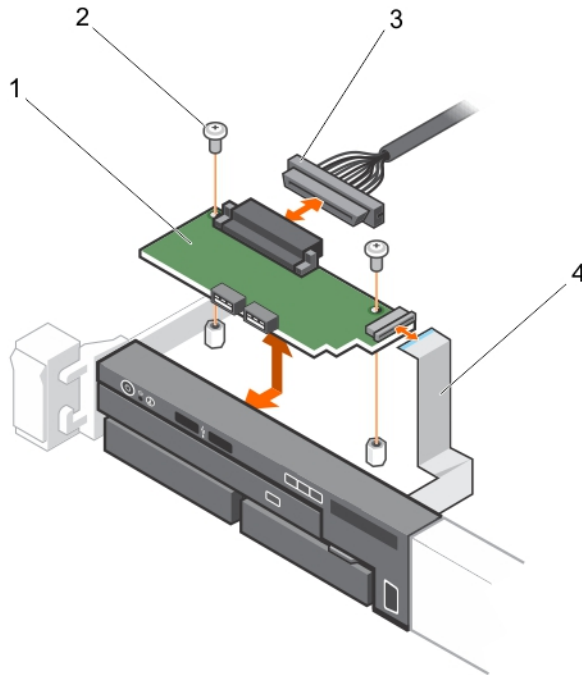

Figure 54. Removing and Installing the control panel module—eight hard-drive chassis

- | | |
|---|-------------------------|
| 1. control panel module | 2. screw (2) |
| 3. control-panel module connector cable | 4. display module cable |

Installing the control-panel module

Prerequisites

⚠ CAUTION: Many repairs may only be done by a certified service technician. You should only perform troubleshooting and simple repairs as authorized in your product documentation, or as directed by the online or telephone service and support team. Damage due to servicing that is not authorized by Dell is not covered by your warranty. Read and follow the safety instructions that came with the product.

1. Ensure that you read the [Safety instructions](#).
2. Follow the procedure listed in [Before working inside your system](#).

Steps

1. For a 3.5 inch cabled hard drive system:
 - a. Insert the LED panel into the slot in the chassis.
 - b. Secure the LED panel with the screws.
2. Insert the control-panel module into the slot in the chassis and align the two screw holes on the control-panel module with the corresponding holes on the chassis.
3. Secure the control-panel module with the screws.

4. Connect all the applicable cables to the control-panel module.

Next steps

Follow the procedure listed in [After working inside your system](#).

Power interposer board

Removing the power interposer board

Prerequisites



CAUTION: Many repairs may only be done by a certified service technician. You should only perform troubleshooting and simple repairs as authorized in your product documentation, or as directed by the online or telephone service and support team. Damage due to servicing that is not authorized by Dell is not covered by your warranty. Read and follow the safety instructions that came with the product.



NOTE: The power interposer board is present only in systems that support redundant power supplies.

1. Ensure that you read the [Safety instructions](#).
2. Follow the procedure listed in [Before working inside your system](#).
3. Remove the power supplies from the system.

Steps

1. Disconnect the power distribution cables from the system board.
2. Disconnect the fan cable.
3. Remove the two screws securing the power interposer board to the chassis and lift the board out of the chassis.

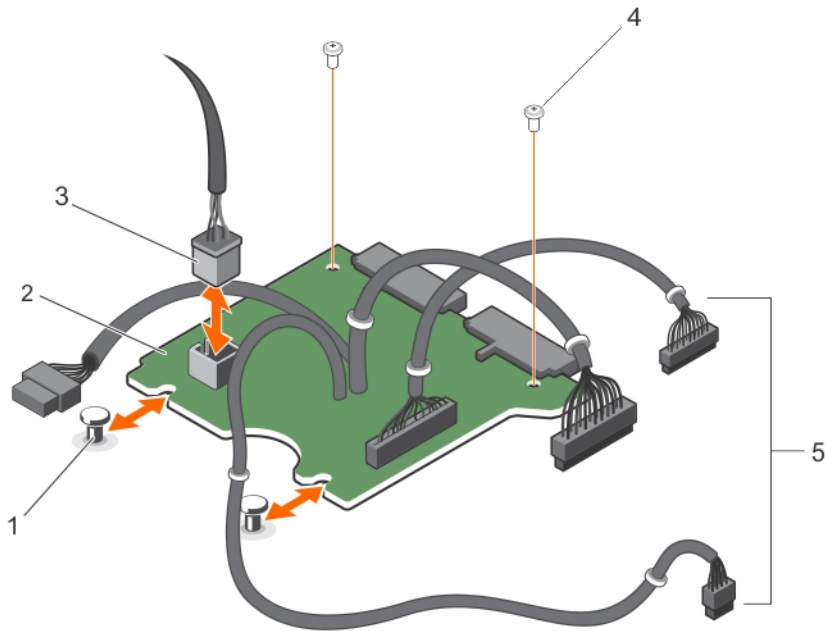

Figure 55. Removing and installing the power interposer board

- | | |
|--|---------------------------|
| 1. standoffs (2) | 2. power interposer board |
| 3. fan cable connector | 4. screw (2) |
| 5. power supply cables to the system board (3) | |

Installing the power interposer board

Prerequisites

⚠ CAUTION: Many repairs may only be done by a certified service technician. You should only perform troubleshooting and simple repairs as authorized in your product documentation, or as directed by the online or telephone service and support team. Damage due to servicing that is not authorized by Dell is not covered by your warranty. Read and follow the safety instructions that came with the product.

Ensure that you read the [Safety instructions](#).

Steps

1. Align the power interposer board with the standoffs on the chassis.
2. Install the two screws that secure the power interposer board to the chassis.
3. Connect the power distribution cables to the system board and fan cable connector to the power interposer board.



Next steps

Follow the procedure listed in [After working inside your system](#).



System board

Removing the system board

Prerequisites

-  **CAUTION:** Many repairs may only be done by a certified service technician. You should only perform troubleshooting and simple repairs as authorized in your product documentation, or as directed by the online or telephone service and support team. Damage due to servicing that is not authorized by Dell is not covered by your warranty. Read and follow the safety instructions that came with the product.
 -  **CAUTION:** If you are using the Trusted Program Module (TPM) with an encryption key, you may be prompted to create a recovery key during program or System Setup. Be sure to create and safely store this recovery key. If you replace this system board, you must supply the recovery key when you restart your system or program before you can access the encrypted data on your hard drives.
 -  **CAUTION:** Do not attempt to remove the TPM plug-in module from the system board. Once the TPM plug-in module is installed, it is cryptographically bound to that specific system board. Any attempt to remove an installed TPM plug-in module breaks the cryptographic binding, and it cannot be re-installed or installed on another system board.
1. Ensure that you read the [Safety instructions](#).
 2. Follow the procedure listed in [Before working inside your system](#).
 3. Remove the following:
 - a. cooling shroud
 - b. memory modules
 - c. cooling fan cables
 - d. expansion cards
 - e. expansion-card riser
 - f. integrated storage controller card
 - g. heat sink and processor
 - h. internal dual SD module

Steps

1. Disconnect all other cables from the system board.
 -  **CAUTION:** Take care not to damage the system identification button while removing the system board from the chassis.
2. Remove the nine screws on the system board and slide the system board toward the front of the system.
3. Hold the system board t-handle and lift the system board out of the chassis.
 -  **NOTE:** To prevent damage to the system board, ensure that you hold the system board by its edges only.
 -  **CAUTION:** Do not lift the system board assembly by holding a memory module, processor, or other components.

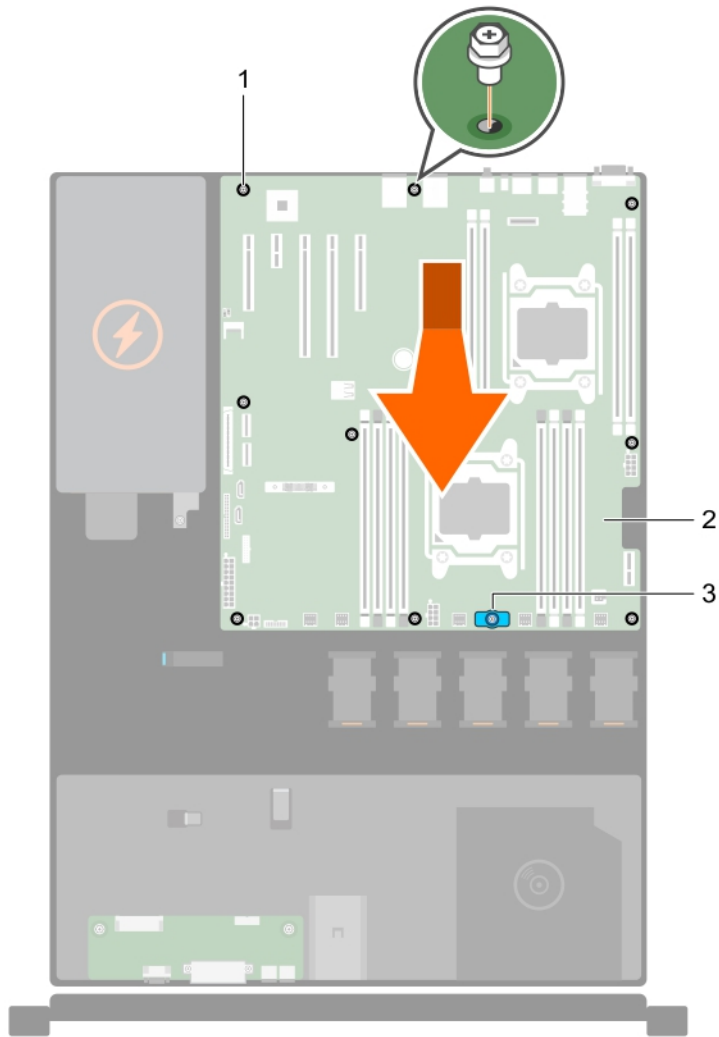

Figure 56. Removing and installing the system board

1. screw (9)
2. system board
3. system board t-handle

Related Links

- [Removing the cooling shroud](#)
- [Removing memory module](#)
- [Removing a cooling fan](#)
- [Removing an expansion card](#)
- [Removing the expansion-card riser](#)
- [Removing the integrated storage controller card](#)
- [Removing a processor](#)
- [Removing an internal SD card](#)

Installing the system board

Prerequisites

 **CAUTION:** Many repairs may only be done by a certified service technician. You should only perform troubleshooting and simple repairs as authorized in your product documentation, or as directed by the online or telephone service and support team. Damage due to servicing that is not authorized by Dell is not covered by your warranty. Read and follow the safety instructions that came with the product.

 **CAUTION:** Do not lift the system board assembly by holding a memory module, processor, or other components.

 **CAUTION:** Take care not to damage the system identification button while placing the system board into the chassis.

1. Ensure that you read the [Safety instructions](#).
2. Unpack the new system board assembly.

Steps

1. Hold the system board by its edges and the system board t-handle, and angle it toward the back of the chassis.
2. Lower the system board into the chassis till the connectors at the back of the system board align with the slots on the rear wall of the chassis, and the screw holes on the system board align with the standoffs on the chassis.
3. Tighten the nine screws that secure the system board to the chassis.

Next steps

1. Install the Trusted Platform Module (TPM). See, [Installing the Trusted Platform Module](#).
2. Replace the following:
 - a. internal dual SD module
 - b. heat sink/heat-sink blank and processor/processor blank
 - c. expansion-card riser
 - d. expansion cards
 - e. integrated storage controller card
 - f. cooling fan cables
 - g. memory modules
 - h. cooling shroud
3. Reconnect all cables to the system board.

 **NOTE:** Ensure that the cables inside the system are routed through the cable routing latch.
4. Follow the procedure listed in [After working inside your system](#).
5. Import your new or existing iDRAC Enterprise license. For more information, see the Integrated Dell Remote Access Controller User's Guide, at dell.com/support/home.
6. Ensure that you:

- a. Use the Easy Restore feature to restore the service tag. See [Restoring the Service Tag using Easy Restore](#).
- b. If the Service Tag is not backed up in the backup flash device, enter the system service tag manually. See [Entering the system Service Tag using System Setup](#).
- c. Update the BIOS and iDRAC versions.
- d. Re-enable the Trusted Platform Module (TPM). See [Re-enabling the TPM for BitLocker users](#) or [Re-enabling the TPM for TXT users](#).

Related Links

- [Installing the cooling shroud](#)
- [Installing memory modules](#)
- [Installing a cooling fan](#)
- [Installing an expansion card](#)
- [Installing the expansion-card riser](#)
- [Installing the integrated storage controller card](#)
- [Installing a processor](#)
- [Removing an internal SD card](#)

Restoring the Service Tag using Easy Restore

Use the Easy Restore feature if you do not know the Service Tag of your system. The Easy Restore feature allows you to restore your system's Service Tag, license, UEFI configuration, and the system configuration data after replacing the system board. All data is backed up in a backup flash device automatically. If BIOS detects a new system board and the Service Tag in the backup flash device, BIOS prompts the user to restore the backup information.

1. Turn on the system.
If BIOS detects a new system board, and if the Service Tag is present in the backup flash device, BIOS displays the Service Tag, the status of the license, and the **UEFI Diagnostics** version.
2. Do one of the following:
 - Press **Y** to restore the Service Tag, license, and diagnostics information.
 - Press **N** to navigate to the Lifecycle Controller based restore options.
 - Press <F10> to restore data from a previously created **Hardware Server Profile**.

After the restore process is complete, BIOS prompts to restore the system configuration data.

3. Do one of the following:
 - Press **Y** to restore the system configuration data.
 - Press **N** to use the default configuration settings.

After the restore process is complete, the system restarts.

Entering the system Service Tag using System Setup

If you know the system Service Tag, use the System Setup menu to enter the Service Tag.

1. Turn on the system.
2. Press <F2> to enter the System Setup.
3. Click **Service Tag Settings**.
4. Enter the Service Tag.

 **NOTE:** You can enter the only when the **Service Tag** field is empty. Ensure that you enter the correct Service Tag. Once the Service Tag is entered, it cannot be updated or changed.

5. Click **Ok**.
6. Import your new or existing iDRAC Enterprise license.
For more information, see Integrated Dell Remote Access Controller User's Guide, at dell.com/esmmanuals.

Trusted Platform Module

The Trusted Platform Module (TPM) is used to generate/store keys, protect/authenticate passwords, and create/store digital certificates. TPM can also be used to enable the BitLocker hard drive encryption feature in Windows Server.

 **CAUTION:** Do not attempt to remove the Trusted Platform Module (TPM) from the system board. Once the TPM is installed, it is cryptographically bound to that specific system board. Any attempt to remove an installed TPM breaks the cryptographic binding, and it cannot be re-installed or installed on another system board.

Installing the Trusted Platform Module

Prerequisites

1. Ensure that you read the [Safety instructions](#).
2. Follow the procedure listed in [Before working inside your system](#).

 **CAUTION:** Do not remove an installed Trusted Platform Module (TPM). Any attempt to remove an installed TPM from the system board may damage the TPM.

Steps

1. Align the edge connectors on the TPM with the slot on the TPM connector.
2. Insert the TPM into the TPM connector such that the plastic bolt aligns with the slot on the system board.
3. Press the plastic bolt until the bolt snaps into place.

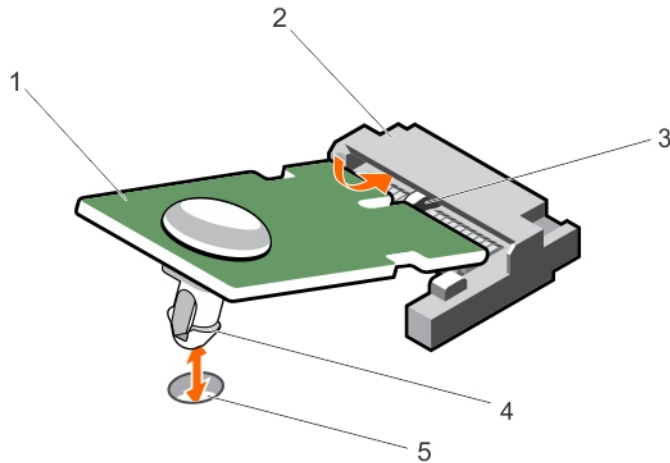

Figure 57. Installing the TPM

- | | |
|------------------------------|------------------|
| 1. TPM | 2. TPM connector |
| 3. slot on the TPM connector | 4. plastic bolt |
| 5. slot on the system board | |

Next steps

Follow the procedure listed in [After working inside your system.](#)

Re-enabling the TPM for BitLocker users

Initialize the TPM.

For more information on initializing the TPM, see <http://technet.microsoft.com/en-us/library/cc753140.aspx>.

The **TPM Status** changes to **Enabled, Activated**.

Re-enabling the TPM for TXT users

1. While booting your system, press <F2> to enter System Setup.
2. In the **System Setup Main Menu**, click **System BIOS** → **System Security Settings**.
3. In the **TPM Security** option, select **On with Pre-boot Measurements**.
4. In the **TPM Command** option, select **Activate**.
5. Save the settings.
6. Restart your system.
7. Enter System Setup again.
8. In the **System Setup Main Menu**, click **System BIOS** → **System Security Settings**.
9. In the **Intel TXT** option, select **On**.

Troubleshooting your system

Safety first—for you and your system

 **CAUTION:** Many repairs may only be done by a certified service technician. You should only perform troubleshooting and simple repairs as authorized in your product documentation, or as directed by the online or telephone service and support team. Damage due to servicing that is not authorized by Dell is not covered by your warranty. Read and follow the safety instructions that came with the product.

Troubleshooting system startup failure

If you boot the system to the BIOS boot mode after installing an operating system from the UEFI Boot Manager, the system hangs. The reverse is also true. You must boot to the same boot mode in which you installed the operating system.

For all other startup issues, note the system messages that appear on the screen.

Troubleshooting external connections

Ensure that all external cables are securely attached to the external connectors on your system before troubleshooting any external devices.

Troubleshooting the video subsystem

1. Check the system and power connections to the monitor.
2. Check the video interface cabling from the system to the monitor.
3. Run the appropriate diagnostic test.

If the tests run successfully, the problem is not related to video hardware.

If the tests fail, see [Getting Help](#).

Troubleshooting a USB device

About this task

Use the following steps to troubleshoot a USB keyboard/mouse. For other USB devices, go to step 7.

Steps

1. Disconnect the keyboard and mouse cables from the system and reconnect them.
2. If the problem persists, connect the keyboard/mouse to the USB port(s) on the opposite side of the system.

3. If the problem is resolved, restart the system, enter the System Setup, and check if the non-functioning USB ports are enabled.
Check if USB 3.0 is enabled in System Setup. If enabled, disable it and see if the issue is resolved (older operating systems may not support USB 3.0).
4. In the **IDRAC Settings Utility**, ensure the **USB Management Port Mode** is configured as **Automatic** or **Standard OS Use**.
5. Replace the keyboard/mouse with a working keyboard/mouse.
If the problem is not resolved, proceed to the next step to begin troubleshooting other USB devices attached to the system.
6. Power down all attached USB devices and disconnect them from the system.
7. Restart the system and, if your keyboard is functioning, enter the System Setup.
8. Verify that all USB ports are enabled on the **Integrated Devices** screen, in the System Setup options.
9. Check if USB 3.0 is enabled in System Setup. If it is enabled, disable it and restart your system.
If your keyboard is not functioning, you can also use remote access.
10. If the system is not accessible, reset the NVRAM_CLR jumper inside your system and restore the BIOS to the default settings.
11. In the **IDRAC Settings Utility**, ensure the **USB Management Port Mode** is configured as **Automatic** or **Standard OS Use**.
12. Reconnect and power on each USB device one at a time.
13. If a USB device causes the same problem, power down the device, replace the USB cable with a known good cable, and power up the device.

Next steps

If all troubleshooting fails, see [Getting Help](#).

Troubleshooting a serial I/O device

Steps

1. Turn off the system and any peripheral devices connected to the serial port.
2. Swap the serial interface cable with a working cable, and turn on the system and the serial device.
If the problem is resolved, replace the interface cable with a known good cable.
3. Turn off the system and the serial device, and swap the device with a comparable device.
4. Turn on the system and the serial device.

Next steps

If the problem persists, see [Getting Help](#).

Troubleshooting a NIC

Steps

1. Run the appropriate diagnostic test. See [Using System Diagnostics](#) for available diagnostic tests.
2. Reboot the system and check for any system messages pertaining to the NIC controller.
3. Check the appropriate indicator on the NIC connector:
 - If the link indicator does not light, check all cable connections.
 - If the activity indicator does not light, the network driver files might be damaged or missing.

- Remove and reinstall the drivers if applicable. See the NIC's documentation.
- If applicable, change the autonegotiation setting.
 - Use another connector on the switch or hub.
4. Ensure that the appropriate drivers are installed and the protocols are bound. See the NIC's documentation.
 5. Enter the System Setup and confirm that the NIC ports are enabled on the **Integrated Devices** screen.
 6. Ensure that the NICs, hubs, and switches on the network are all set to the same data transmission speed and duplex. See the documentation for each network device.
 7. Ensure that all network cables are of the proper type and do not exceed the maximum length.

Next steps

If all troubleshooting fails, see [Getting Help](#).

Troubleshooting a wet system

Prerequisites



CAUTION: Many repairs may only be done by a certified service technician. You should only perform troubleshooting and simple repairs as authorized in your product documentation, or as directed by the online or telephone service and support team. Damage due to servicing that is not authorized by Dell is not covered by your warranty. Read and follow the safety instructions that came with the product.

Steps

1. Turn off the system and attached peripherals, and disconnect the system from the electrical outlet.
2. Remove the system cover.
3. Remove the following components from the system:
 - hard drives
 - hard-drive backplane
 - USB memory key
 - hard-drive tray
 - cooling shroud
 - expansion-card risers (if present)
 - expansion cards
 - power supply unit(s)
 - cooling-fan assembly (if present)
 - cooling fans
 - processor(s) and heat sink(s)
 - memory modules
4. Let the system dry thoroughly for at least 24 hours.
5. Reinstall the components you removed in step 3.
6. Install the system cover.
7. Turn on the system and attached peripherals.
If the system does not start properly, see [Getting Help](#).
8. If the system starts properly, shut down the system, and reinstall all the expansion cards that you removed.

9. Run the appropriate diagnostic test. For more information, see [Using System Diagnostics](#).

Next steps

If the tests fail, see [Getting Help](#).

Troubleshooting a damaged system

Prerequisites

 **CAUTION:** Many repairs may only be done by a certified service technician. You should only perform troubleshooting and simple repairs as authorized in your product documentation, or as directed by the online or telephone service and support team. Damage due to servicing that is not authorized by Dell is not covered by your warranty. Read and follow the safety instructions that came with the product.

Steps

1. Turn off the system and attached peripherals, and disconnect the system from the electrical outlet.
2. Remove the system cover.
3. Ensure that the following components are properly installed:
 - Cooling shroud
 - Expansion-card risers (if present)
 - Expansion cards
 - Power supply(s)
 - Cooling-fan assembly (if present)
 - Cooling fans
 - Processor(s) and heat sink(s)
 - Memory modules
 - Hard-drive carriers
 - Hard-drive backplane
4. Ensure that all cables are properly connected.
5. Install the system cover.
6. Run the appropriate diagnostic test. For more information, see [Using System Diagnostics](#).

Next steps

If the tests fail, see [Getting Help](#).

Troubleshooting the system battery

Prerequisites

 **CAUTION:** Many repairs may only be done by a certified service technician. You should only perform troubleshooting and simple repairs as authorized in your product documentation, or as directed by the online or telephone service and support team. Damage due to servicing that is not authorized by Dell is not covered by your warranty. Read and follow the safety instructions that came with the product.

 **NOTE:** If the system is turned off for long periods of time (for weeks or months), the NVRAM may lose its system configuration information. This situation is caused by a defective battery.

Steps

1. Re-enter the time and date in the System Setup.
2. Turn off the system and disconnect it from the electrical outlet for at least one hour.
3. Reconnect the system to the electrical outlet and turn on the system.
4. Enter the System Setup.
If the date and time are not correct in the System Setup, check the SEL for system battery messages.

Next steps

If the problem persists, see [Getting Help](#).

 **NOTE:** Some software may cause the system time to speed up or slow down. If the system seems to operate normally except for the time kept in the System Setup, the problem may be caused by software rather than by a defective battery.

Troubleshooting power supply units

 **CAUTION:** Many repairs may only be done by a certified service technician. You should only perform troubleshooting and simple repairs as authorized in your product documentation, or as directed by the online or telephone service and support team. Damage due to servicing that is not authorized by Dell is not covered by your warranty. Read and follow the safety instructions that came with the product.

Power source problems

1. Press the power button to ensure that your system is turned on. If the power indicator does not light up when the power button is pressed, press the power-on button firmly.
2. Plug in another working device to ensure that the system board is not faulty.
3. Ensure that no loose connections exist.
For example, loose power cables.
4. Ensure that the power source meets applicable standards.
5. Ensure that there are no short circuits.
6. Have a qualified electrician check the line voltage to ensure that it meets the required specifications.

Power supply unit problems

1. Ensure that no loose connections exist.
For example, loose power cables.
2. Ensure that the power supply handle/LED indicates that the power supply is working properly.
3. If you have recently upgraded your system, ensure that the power supply unit has enough power to support the new system.
4. If you have a redundant power supply configuration, ensure that both the power supply units are of the same type and wattage.
If the LED You may have to upgrade to a higher wattage power supply unit.
5. Ensure that you use only power supply units with the Extended Power Performance (EPP) label on the back.
6. Reseat the power supply unit.

 **NOTE:** After installing a power supply unit, allow several seconds for the system to recognize the power supply unit and determine if it is working properly.

If the problem persists, see [Getting Help](#).

Troubleshooting cooling problems

 **CAUTION:** Many repairs may only be done by a certified service technician. You should only perform troubleshooting and simple repairs as authorized in your product documentation, or as directed by the online or telephone service and support team. Damage due to servicing that is not authorized by Dell is not covered by your warranty. Read and follow the safety instructions that came with the product.

Ensure that the following conditions exist:

- System cover, cooling shroud, EMI filler panel, memory-module blank, or back-filler bracket is not removed.
- Ambient temperature is not too high.
- External airflow is not obstructed.
- A cooling fan is not removed or has not failed.
- The expansion card installation guidelines have been followed.

Additional cooling can be added by one of the following methods:

From the iDRAC Web GUI

1. Click **Hardware** → **Fans** → **Setup**.
2. From the **Fan Speed Offset** drop-down list, select the cooling level needed or set the minimum fan speed to a custom value.

From F2 System Setup

1. Select **iDRAC Settings** → **Thermal**, and set a higher fan speed from the fan speed offset or minimum fan speed.

From RACADM commands

1. Run the command `racadm help system.thermalsettings`

For more information, see the Integrated Dell Remote Access User's Guide at dell.com/esmmanuals.

Troubleshooting cooling fans

Prerequisites

 **CAUTION:** Many repairs may only be done by a certified service technician. You should only perform troubleshooting and simple repairs as authorized in your product documentation, or as directed by the online or telephone service and support team. Damage due to servicing that is not authorized by Dell is not covered by your warranty. Read and follow the safety instructions that came with the product.

 **NOTE:** In the event of a problem with a particular fan, the fan number is referenced by the system's management software, allowing you to easily identify and replace the proper fan by noting the fan numbers on the cooling fan assembly.

Steps

1. Remove the system cover.
2. Reseat the fan or the fan's power cable.
3. Install the system cover.
4. Restart your system.,

Next steps

If the problem persists, see [Getting Help](#).

Troubleshooting system memory

Prerequisites



CAUTION: Many repairs may only be done by a certified service technician. You should only perform troubleshooting and simple repairs as authorized in your product documentation, or as directed by the online or telephone service and support team. Damage due to servicing that is not authorized by Dell is not covered by your warranty. Read and follow the safety instructions that came with the product.

Steps

1. If the system is operational, run the appropriate diagnostic test. See [Using system diagnostics](#) for available diagnostic tests.
If diagnostics indicate a fault, follow the corrective actions provided by the diagnostic program.
2. If the system is not operational, turn off the system and attached peripherals, and unplug the system from the power source. Wait at least 10 seconds and then reconnect the system to the power source.
3. Turn on the system and attached peripherals and note the messages on the screen.
If an error message is displayed indicating a fault with a specific memory module, go to step 12.
4. Enter the System Setup and check the system memory setting. Make any changes to the memory settings, if needed.
If the memory settings match the installed memory but the problem still persists, go to step 12.
5. Turn off the system and attached peripherals, and disconnect the system from the electrical outlet.
6. Remove the system cover.
7. Check the memory channels and ensure that they are populated correctly.
 **NOTE:** See the system event log or system messages for the location of the failed memory module. Reinstall the memory device.
8. Reseat the memory modules in their sockets.
9. Install the system.
10. Enter the System Setup and check the system memory setting.
If the problem is not resolved, proceed with the next step.
11. Remove the system cover.
12. If a diagnostic test or error message indicates a specific memory module as faulty, swap or replace the module with a known good memory module.
13. To troubleshoot an unspecified faulty memory module, replace the memory module in the first DIMM socket with a module of the same type and capacity.
If an error message is displayed on the screen, this may indicate a problem with the installed DIMM type(s), incorrect DIMM installation, or defective DIMM(s). Follow the on-screen instructions to resolve the problem.

14. Install the system cover.
15. As the system boots, observe any error message that is displayed and the diagnostic indicators on the front of the system.
16. If the memory problem persists, repeat step 12 through step 15 for each memory module installed.

Next steps

If the problem persists after all memory modules have been checked, see [Getting Help](#).

Troubleshooting an internal USB key

Prerequisites

 **CAUTION:** Many repairs may only be done by a certified service technician. You should only perform troubleshooting and simple repairs as authorized in your product documentation, or as directed by the online or telephone service and support team. Damage due to servicing that is not authorized by Dell is not covered by your warranty. Read and follow the safety instructions that came with the product.

Steps

1. Enter the System Setup and ensure that the **USB key port** is enabled on the **Integrated Devices** screen.
2. Turn off the system and attached peripherals, and disconnect the system from the electrical outlet.
3. Remove the system cover.
4. Locate the USB key and reseat it.
5. Install the system cover.
6. Turn on the system and attached peripherals and check if the USB key is functioning.
7. If the problem is not resolved, repeat step 2 and step 3.
8. Insert a different USB key that you know works properly.
9. Install the system cover.

Next steps

If the problem is not resolved, see [Getting Help](#).

Troubleshooting an SD card

Prerequisites

 **CAUTION:** Many repairs may only be done by a certified service technician. You should only perform troubleshooting and simple repairs as authorized in your product documentation, or as directed by the online or telephone service and support team. Damage due to servicing that is not authorized by Dell is not covered by your warranty. Read and follow the safety instructions that came with the product.

 **NOTE:** Certain SD cards have a physical write-protect switch on the card. If the write-protect switch is turned on, the SD card is not writeable.

Steps

1. Enter the System Setup and ensure that the **Internal SD Card Port** is enabled.
2. Turn off the system, including any attached peripherals, and disconnect the system from the electrical outlet.
3. Remove the system cover.

 **NOTE:** When an SD card failure occurs, the internal dual SD module controller notifies the system. On the next restart, the system displays a message indicating the failure. If redundancy is enabled at the time of SD card failure, a critical alert will be logged and chassis health will degrade.

4. Replace the failed SD card with a new SD card.
5. Install the system cover.
6. Reconnect the system to its electrical outlet and turn the system on, including any attached peripherals.
7. Enter the System Setup and ensure that the **Internal SD Card Port** and **Internal SD Card Redundancy** mode is set to the required mode.
Verify that correct SD slot is set as **Primary SD Card**.
8. Check if the SD card is functioning properly.
9. If the **Internal SD Card Redundancy** option is set to **Enabled** at the time of the SD card failure, the system will prompt you to perform a rebuild.

 **NOTE:** The rebuild will always be sourced from the primary SD card to the secondary SD card. Perform the rebuild of the SD card as necessary.

Troubleshooting an optical drive

Prerequisites



CAUTION: Many repairs may only be done by a certified service technician. You should only perform troubleshooting and simple repairs as authorized in your product documentation, or as directed by the online or telephone service and support team. Damage due to servicing that is not authorized by Dell is not covered by your warranty. Read and follow the safety instructions that came with the product.

Steps

1. Try using a different CD or DVD.
2. Enter the System Setup and ensure that the integrated SATA controller and the drive's SATA port are enabled.
3. Run the appropriate diagnostic test.
4. Turn off the system and attached peripherals, and disconnect the system from the electrical outlet.
5. If installed, remove the front bezel.
6. Remove the system cover.
7. Ensure that the interface cable is securely connected to the optical drive and to the controller.
8. Ensure that a power cable is properly connected to the drive.
9. Install the system cover.

Next steps

If the problem is not resolved, see [Getting Help](#).

Troubleshooting a tape backup unit

Prerequisites

 **CAUTION:** Many repairs may only be done by a certified service technician. You should only perform troubleshooting and simple repairs as authorized in your product documentation, or as directed by the online or telephone service and support team. Damage due to servicing that is not authorized by Dell is not covered by your warranty. Read and follow the safety instructions that came with the product.

Steps

1. Use a different tape cartridge.
2. Ensure that the device drivers for the tape backup unit are installed and are configured correctly. See your tape drive documentation for more information about device drivers.
3. Reinstall the tape-backup software as instructed in the tape-backup software documentation.
4. Ensure that the interface cable of the tape drive is connected to the external port on the controller card.
5. Perform the following steps to ensure that the controller card is properly installed:
 - a. Turn off the system and attached peripherals, and disconnect the system from the electrical outlet.
 - b. Remove the system cover.
 - c. Reseat the controller card in the expansion card slot.
 - d. Install the system cover.
 - e. Turn on the system and attached peripherals.
6. Run the appropriate diagnostic test. For more information, see [Using System Diagnostics](#).

Next steps

If you cannot resolve the problem, see [Getting Help](#).

Troubleshooting a hard drive

Prerequisites

 **CAUTION:** Many repairs may only be done by a certified service technician. You should only perform troubleshooting and simple repairs as authorized in your product documentation, or as directed by the online or telephone service and support team. Damage due to servicing that is not authorized by Dell is not covered by your warranty. Read and follow the safety instructions that came with the product.

 **CAUTION:** This troubleshooting procedure can erase data stored on the hard drive. Before you proceed, back up all files on the hard drive.

Steps

1. Run the appropriate diagnostic test. For more information, see [Using System Diagnostics](#). Depending on the results of the diagnostics test, proceed as needed through the following steps.
2. If your system has a RAID controller and your hard drives are configured in a RAID array, perform the following steps:
 - a. Reboot the system and press <F10> during system startup to run the Lifecycle Controller, and then run the Hardware Configuration wizard to check the RAID configuration. See the Lifecycle Controller documentation or online help for information on RAID configuration.
 - b. Ensure that the hard drive(s) are configured correctly for the RAID array.

- c. Take the hard drive offline and reseat the drive.
- d. Exit the configuration utility and allow the system to boot to the operating system.
3. Ensure that the required device drivers for your controller card are installed and are configured correctly. See the operating system documentation for more information.
4. Reboot the system and enter the System Setup.
5. Verify that the controller is enabled and the drives are displayed in the System Setup.

Next steps

If the problem persists, try troubleshooting the expansion cards or see [Getting Help](#).

Troubleshooting a storage controller

 **CAUTION:** Many repairs may only be done by a certified service technician. You should only perform troubleshooting and simple repairs as authorized in your product documentation, or as directed by the online or telephone service and support team. Damage due to servicing that is not authorized by Dell is not covered by your warranty. Read and follow the safety instructions that came with the product.

 **NOTE:** When troubleshooting a SAS or PERC controller, see the documentation for your operating system and the controller.

1. Run the appropriate diagnostic test. For more information, see [Using System Diagnostics](#).
2. Turn off the system and attached peripherals, and disconnect the system from the electrical outlet.
3. Remove the system cover.
4. Verify that the installed expansion cards are compliant with the expansion card installation guidelines.
5. Ensure that each expansion card is firmly seated in its connector.
6. Install the system cover.
7. Reconnect the system to the electrical outlet, and turn on the system and attached peripherals.
8. If the problem is not resolved, turn off the system and attached peripherals, and disconnect the system from the electrical outlet.
9. Remove the system cover.
10. Remove all expansion cards installed in the system.
11. Install the system cover.
12. Reconnect the system to the electrical outlet, and turn on the system and attached peripherals.
13. Run the appropriate diagnostic test. For more information, see [Using System Diagnostics](#). If the tests fail, see [Getting Help](#).
14. For each expansion card you removed in step 10, perform the following steps:
 - a. Turn off the system and attached peripherals, and disconnect the system from the electrical outlet.
 - b. Remove the system cover.
 - c. Reinstall one of the expansion cards.
 - d. Install the system cover.
 - e. Run the appropriate diagnostic test. For more information, see [Using System Diagnostics](#).

If the tests fail, see [Getting Help](#).

Troubleshooting expansion cards

Prerequisites

 **CAUTION:** Many repairs may only be done by a certified service technician. You should only perform troubleshooting and simple repairs as authorized in your product documentation, or as directed by the online or telephone service and support team. Damage due to servicing that is not authorized by Dell is not covered by your warranty. Read and follow the safety instructions that came with the product.

 **NOTE:** When troubleshooting an expansion card, see the documentation for your operating system and the expansion card.

Steps

1. Run the appropriate diagnostic test. For more information, see [Using System Diagnostics](#) .
2. Turn off the system and attached peripherals, and disconnect the system from the electrical outlet.
3. Open the system.
4. Ensure that each expansion card is firmly seated in its connector.
5. Close the system.
6. If the problem is not resolved, turn off the system and attached peripherals, and disconnect the system from the electrical outlet.
7. Open the system.
8. Remove all expansion cards installed in the system.
9. Close the system.
10. Run the appropriate diagnostic test. For more information, see [Using System Diagnostics](#) .
If the tests fail, see [Getting Help](#).
11. For each expansion card you removed in step 8, perform the following steps:
 - a. Turn off the system and attached peripherals, and disconnect the system from the electrical outlet.
 - b. Open the system.
 - c. Reinstall one of the expansion cards.
 - d. Close the system.
 - e. Run the appropriate diagnostic test. For more information, see [Using System Diagnostics](#) .

Next steps

If the problem persists, see [Getting Help](#).

Troubleshooting processors

Prerequisites

 **CAUTION:** Many repairs may only be done by a certified service technician. You should only perform troubleshooting and simple repairs as authorized in your product documentation, or as directed by the online or telephone service and support team. Damage due to servicing that is not authorized by Dell is not covered by your warranty. Read and follow the safety instructions that came with the product.

Steps

1. Run the appropriate diagnostics test. See [Using System Diagnostics](#) for available diagnostic tests.
2. Turn off the system and attached peripherals, and disconnect the system from the electrical outlet.

3. Open the system.
4. Ensure that the processor and heat sink are properly installed.
5. Close the system.
6. Run the appropriate diagnostic test. For more information, see [Using System Diagnostics](#).

Next steps

If the problem persists, see [Getting Help](#).

System messages

For a list of event and error messages generated by the system firmware and agents that monitor system components, see the Dell Event and Error Messages Reference Guide at dell.com/esmmanuals.

Warning messages

A warning message alerts you to a possible problem and prompts you to respond before the system continues a task. For example, before you format a hard drive, a message warns you that you may lose all data on the hard drive. Warning messages usually interrupt the task and require you to respond by typing y (yes) or n (no).

 **NOTE:** Warning messages are generated by either the application or the operating system. For more information, see the documentation that accompanied the operating system or application.

Diagnostic messages

The system diagnostic utilities may issue messages if you run diagnostic tests on your system. See [Using system diagnostics](#) for more information about system diagnostics.

Alert messages

The systems management software generates alert messages for your system. Alert messages include information, status, warning, and failure messages for drive, temperature, fan, and power conditions. For more information, see the systems management software documentation.

Using system diagnostics

If you experience a problem with your system, run the system diagnostics before contacting Dell for technical assistance. The purpose of running system diagnostics is to test your system hardware without requiring additional equipment or risking data loss. If you are unable to fix the problem yourself, service and support personnel can use the diagnostics results to help you solve the problem.

Dell Embedded System Diagnostics

 **NOTE:** The Dell Embedded System Diagnostics is also known as Enhanced Pre-boot System Assessment (ePSA) diagnostics.

The embedded system diagnostics provides a set of options for particular device groups or devices allowing you to:

- Run tests automatically or in an interactive mode
- Repeat tests
- Display or save test results
- Run thorough tests to introduce additional test options to provide extra information about the failed device(s)
- View status messages that inform you if tests are completed successfully
- View error messages that inform you of problems encountered during testing

When to use the Embedded System Diagnostics

If a major component or device in the system does not operate properly, running the embedded system diagnostics may indicate component failure.

Running the Embedded System Diagnostics from Boot Manager

1. As the system boots, press <F11>.
2. Use the up and down arrow keys to select **System Utilities** → **Launch Diagnostics**.
The **ePSA Pre-boot System Assessment** window is displayed, listing all devices detected in the system. The diagnostics starts executing the tests on all the detected devices.

Running the Embedded System Diagnostics from the Dell Lifecycle Controller

1. As the system boots, press <F11>.
2. Select **Hardware Diagnostics** → **Run Hardware Diagnostics**.
The **ePSA Pre-boot System Assessment** window is displayed, listing all devices detected in the system. The diagnostics starts executing the tests on all the detected devices.

System diagnostic controls

Menu	Description
Configuration	Displays the configuration and status information of all detected devices.
Results	Displays the results of all tests that are executed.
System health	Provides the current overview of the system performance.
Event log	Displays a time-stamped log of the results of all tests run on the system. This is displayed if at least one event description is recorded.





For information about embedded system diagnostics, see the *ePSA Diagnostics Guide (Notebooks, Desktops and Servers)* at dell.com/support/home.

Jumpers and connectors

System board jumper settings

For information on resetting the password jumper to disable a password, see [Disabling a Forgotten Password](#).

Table 5. System board jumper settings

Jumper	Setting	Description
PWRD_EN	 2 4 6 (default)	The password reset feature is enabled (pins 2–4).
	 2 4 6	The password reset feature is disabled (pins 4–6). The iDRAC local access is unlocked at the next AC power cycle.
NVRAM_CLR	 1 3 5 (default)	The configuration settings are retained at the next system boot (pins 3–5).
	 1 3 5	The configuration settings are cleared at system boot (pins 1–3).

System board connectors

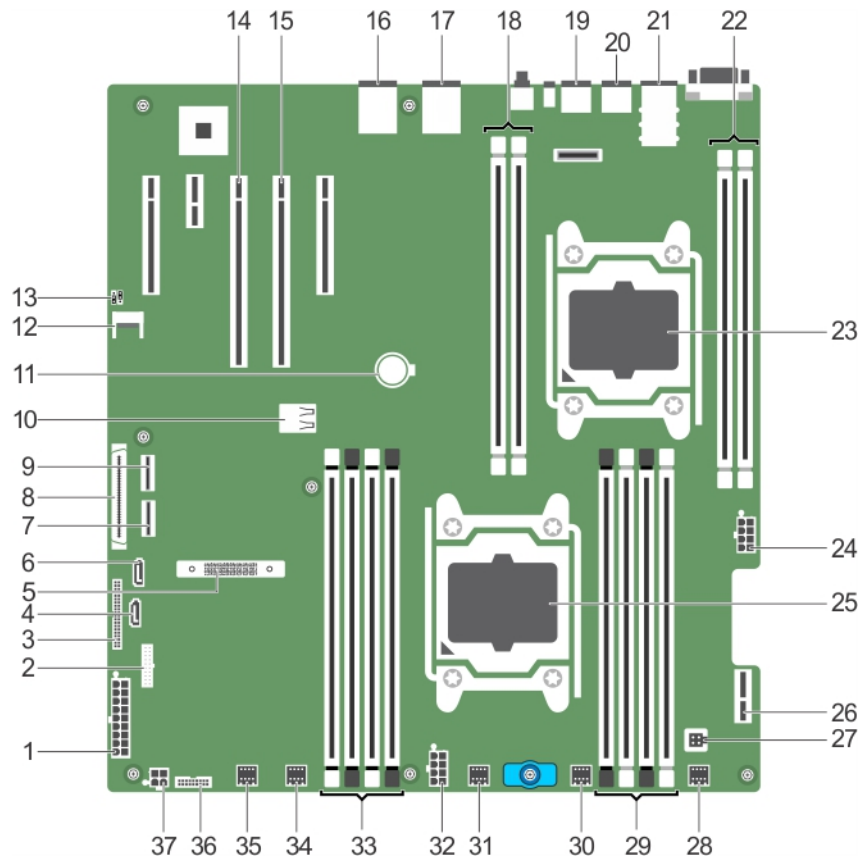



Figure 58. System board jumpers and connectors

Item	Connector	Description
1	SYS_PWR_CONN (P1)	24-pin power connector
2	FB_USB	Front-panel USB connector
3	PIB_CONN	Power interposer board connector
4	SATA_CDRM	SATA connector CDROM
5	MiniPERC PCIE_G3_X8 (CPU1)	Mini PERC card connector
6	SATA_TBU	SATA connector tape backup unit
7	SW_RAID_B	Software RAID connector B
8	CTRL_PNL	Control panel interface connector
9	SW_RAID_A	Software RAID connector A
10	INT_USB_3.0	Internal USB connector
11	BATTERY	Battery connector

Item	Connector	Description
12	TPM_MODULE	Trusted platform module connector
13	J_PSWD_NVRAM	For more information, see System board jumper settings
14	SLOT3 PCIE_G3_X16(CPU1)	PCIe card connector 3
15	SLOT2 PCIE_G3_X16(CPU1)	PCIe card connector 2
		 NOTE: The PCIE_G3_X8 and PCIE_G3_X16 are the two different types of risers supported on R430 systems. You can install an expansion card on the system board only using expansion-card riser. For more information about the installation guidelines, see Expansion card installation guidelines .
16	NIC4	Network connector
17	NIC3	Network connector
18	B1, B2	Memory module socket
19	USB2_3.0	USB connector
20	USB1	USB connector
21	NIC1 and NIC2	Network connector
22	B3, B4	Memory module socket
23	CPU2	Processor socket 2
24	PWR_CONN_C(P3)	8-pin power connector
25	CPU1	Processor socket 1
26	IDSDM	Internal Dual SD Module connector
27	INTRUSION	Intrusion switch connector
28	FAN6	Cooling fan connector
29	A1, A5, A2, A6	Memory module socket
30	FAN5	Cooling fan connector
31	FAN4	Cooling fan connector
32	PWR_CONN_B(P2)	8-pin power connector
33	A3, A7, A4, A8	Memory module socket
34	FAN3	Cooling fan connector
35	FAN2	Cooling fan connector
36	BP_SIG	Backplane signal connector

Item	Connector	Description
37	ODD_PWR	Optical disk drive connector

Disabling a forgotten password

The system's software security features include a system password and a setup password. The password jumper enables these password features or disables them and clears any password(s) currently in use.

Prerequisites

 **CAUTION:** Many repairs may only be done by a certified service technician. You should only perform troubleshooting and simple repairs as authorized in your product documentation, or as directed by the online or telephone service and support team. Damage due to servicing that is not authorized by Dell is not covered by your warranty. Read and follow the safety instructions that came with the product.

Steps

1. Turn off the system, including any attached peripherals, and disconnect the system from the electrical outlet.
2. Open the system.
3. Move the jumper on the system-board jumper from pins 4 and 6 to pins 2 and 4.
4. Close the system.

The existing passwords are not disabled (erased) until the system boots with the jumper on pins 2 and 4. However, before you assign a new system and/or setup password, you must move the jumper back to pins 4 and 6.

 **NOTE:** If you assign a new system and/or setup password with the jumper on pins 2 and 4, the system disables the new password(s) the next time it boots.

5. Reconnect the system to its electrical outlet and turn the system on, including any attached peripherals.
6. Turn off the system, including any attached peripherals, and disconnect the system from the electrical outlet.
7. Open the system.
8. Move the jumper on the system-board jumper from pins 2 and 4 to pins 4 and 6.
9. Close the system.
10. Reconnect the system to its electrical outlet and turn the system on, including any attached peripherals.
11. Assign a new system and/or setup password.



Technical specifications

Physical	
Height	42.8 mm (1.68 inch)
Width	
With rack latches	482.4 mm (18.99 inch)
Without rack latches	434.0 mm (17.08 inch)
Depth (excludes bezel)	607.0 mm (23.9 inch)
Weight (maximum)	19.9 kg (43.87 lb)
Weight (empty)	16.73 kg (36.88 lb)
Processor	
Processor type	Intel Xeon EP E5-2600 v3 product family
Expansion Bus	
Bus type	PCI Express Generation 2 and 3
Expansion slots using the expansion-card riser	
PCIE_G3_X16	(Slot 1) one half-height, half-length x16 link for processor 1 (Slot 2) one half-height, half-length x16 link for processor 1
PCIE_G3_X8	(Slot 1) one Full-height, half-length x8 link for processor 1 (Slot 2) one half-height, half-length x8 link for processor 1
Memory	
Architecture	1333 MT/s, 1600 MT/s, 1866 MT/s, or 2133 MT/s DDR4 Registered DIMMs Support for advanced ECC or memory optimized operation
Memory module sockets	Twelve 288-pin

Memory

Memory module capacities (RDIMMs)	4 GB (single-rank), 8 GB (single- and dual-rank), 16 GB (single- and dual-rank), and 32 GB (single- and dual-rank)
Minimum RAM	4 GB with single processor 8 GB with dual processor
Maximum RAM	Up to 192 GB with single processor Up to 384 GB with dual processor

Power

AC power supply (per power supply)	
Wattage	450 W or 550 W
Power rating per power supply unit	550 W (Platinum) AC (100–240 V, 50/60 Hz, 7.4 A–3.7 A) 450 W (Bronze) AC (100–240 V, 50/60 Hz, 6.5 A–3.5 A)
Heat Dissipation	2107 BTU/hr (550W power supply) 1871 BTU/hr (450W power supply)
 NOTE: Heat dissipation is calculated using the power supply wattage rating.	
Voltage	100-240 V AC, autoranging, 50/60 Hz
 NOTE: This system is also designed to be connected to IT power systems with a phase to phase voltage not exceeding 230 V.	



RAID Controller

Controller type	PERC 9
-----------------	--------

Drives

Hard drives	
Four hard-drive systems	Up to four 3.5 inch cabled hard drives, or Up to four 3.5 inch hot-swappable SAS, SATA, or Nearline SAS hard drives, or Up to four 2.5 inch hot-swappable SAS, SATA, SATA SSD, or Nearline SAS hard drives.  NOTE: Four hard-drive systems support software RAID. For more information on software RAID, see the Dell PowerEdge RAID Controller (PERC) documentation at dell.com/support/home .

Drives

Eight hard-drive systems	Up to eight 2.5 inch, hot-swappable SAS, SATA, SATA SSD, or Nearline SAS hard drives
Ten hard-drive systems	Up to ten 2.5 inch, hot-swappable SATA HDD or SATA SSD
Optical drive	
Four hard-drive systems	One optional slim SATA DV-DROM or DVD+/-RW drive  NOTE: DVD devices are data only.
Eight hard-drive systems	One optional ultra slim SATA DV-DROM or DVD +/-RW drive  NOTE: DVD devices are data only.

Connectors

Back

NIC	Four 10/100/1000 Mbps
Serial	9-pin, DTE, 16550-compatible
USB	One 9-pin, USB 3.0-compliant One 4-pin, USB 2.0-compliant
Video	15-pin VGA
iDRAC8	One optional 1 GbE Ethernet
External vFlash card	One optional vFlash memory card  NOTE: The card slot is available for use only if the iDRAC8 Enterprise license is installed on your system.

Front

USB	Two 4-pin, USB 2.0-compliant
Video	15-pin VGA

Internal

USB	One 9-pin, USB 3.0-compliant
Internal Dual SD Module (IDSDM)	Two optional flash memory card slots with the internal SD module  NOTE: One card slot is dedicated for redundancy.

Video

Video type	Integrated Matrox G200
Video memory	16 MB shared

Environmental specifications



NOTE: For additional information about environmental measurements for specific system configurations, see dell.com/environmental_datasheets.

Temperature

Storage	–40°C to 65°C (–40°F to 149°F)
Continuous operation (for altitude less than 950 m or 3117 ft)	10°C to 35°C (50°F to 95°F) with no direct sunlight on the equipment.
Fresh air	For information on fresh air, see Expanded Operating Temperature section.
Maximum temperature gradient (operating and storage)	20°C/h (36°F/h)

Relative humidity

Storage	5% to 95% RH with 33°C (91°F) maximum dew point. Atmosphere must be non-condensing at all times.
Operating	10% to 80% Relative Humidity with 29°C (84.2°F) maximum dew point.

Maximum vibration

Operating	0.26 G _{rms} at 5 Hz to 350 Hz (all operation orientations).
Storage	1.88 G _{rms} at 10 Hz to 500 Hz for 15 min (all six sides tested).

Maximum shock

Operating	Six consecutively executed shock pulses in the positive and negative x, y, and z axes of 40 G for up to 2.3 ms.
Storage	Six consecutively executed shock pulses in the positive and negative x, y, and z axes (one pulse on each side of the system) of 71 G for up to 2 ms.

Maximum altitude

Operating	3048 m (10,000 ft).
Storage	12,000 m (39,370 ft).

Operating temperature de-rating

Environmental specifications

Up to 35 °C (95 °F)	Maximum temperature is reduced by 1°C/300 m (1°F/547 ft) above 950 m (3,117 ft).
35 °C to 40 °C (95 °F to 104 °F)	Maximum temperature is reduced by 1°C/175 m (1°F/319 ft) above 950 m (3,117 ft).
40 °C to 45 °C (104 °F to 113 °F)	Maximum temperature is reduced by 1°C/125 m (1°F/228 ft) above 950 m (3,117 ft).

Particulate contamination

 **NOTE:** This section defines the limits to help avoid IT equipment damage and/or failure from particulates and gaseous contamination. If it is determined that levels of particulates or gaseous pollution are beyond the limits specified below and are the reason for the damage and/or failures to your equipment, it may be necessary for you to re-mediate the environmental conditions that are causing the damage and/or failures. Re-mediation of environmental conditions will be the responsibility of the customer.

Air filtration

Data center air filtration as defined by ISO Class 8 per ISO 14644-1 with a 95% upper confidence limit.

 **NOTE:** Applies to data center environments only. Air filtration requirements do not apply to IT equipment designed to be used outside a data center, in environments such as an office or factory floor.

 **NOTE:** Air entering the data center must have MERV11 or MERV13 filtration.

Conductive dust

Air must be free of conductive dust, zinc whiskers, or other conductive particles.

 **NOTE:** Applies to data center and non-data center environments.

Corrosive dust

- Air must be free of corrosive dust.
- Residual dust present in the air must have a deliquescent point less than 60% relative humidity.

 **NOTE:** Applies to data center and non-data center environments.

Gaseous contamination

 **NOTE:** Maximum corrosive contaminant levels measured at $\leq 50\%$ relative humidity.

Copper coupon corrosion rate <300 Å/month per Class G1 as defined by ANSI/ISA71.04-1985.

Silver coupon corrosion rate <200 Å/month as defined by AHSRAE TC9.9.

Expanded Operating Temperature

 **NOTE:** When operating in the expanded temperature range, system performance may be impacted.

 **NOTE:** When operating in the expanded temperature range, ambient temperature warnings may be reported on the LCD and in the System Event Log.

$\leq 10\%$ of annual operating hours 5 °C to 40 °C at 5% to 85% RH with 26 °C dew point.

Expanded Operating Temperature

 **NOTE:** Outside the standard operating temperature (10 °C to 35 °C), the system can operate down to 5 °C or up to 40 °C for a maximum of 10% of its annual operating hours.

For temperatures between 35 °C and 40 °C, de-rate maximum allowable dry bulb temperature by 1 °C per 175 m above 950 m (1 °F per 319 ft).

≤ 1% of annual operating hours

–5 °C to 45 °C at 5% to 90% RH with 26 °C dew point.

 **NOTE:** Outside the standard operating temperature (10 °C to 35 °C), the system can operate down to –5 °C or up to 45 °C for a maximum of 1% of its annual operating hours.

For temperatures between 40 °C and 45 °C, de-rate maximum allowable dry bulb temperature by 1 °C per 125 m above 950 m (1 °F per 228 ft).

Expanded Operating Temperature Restrictions

- Processors of 55 W and 65 W are not supported.
- Do not perform a cold startup below 5 °C.
- Allow processor performance degrade.
- Non-redundant power supplies are not supported.
- Non Dell qualified peripheral cards and/or peripheral cards are not supported.
- Maximum altitude for the operating temperature must be 3050 m (10,000 ft).

Getting help

Contacting Dell

Dell provides several online and telephone-based support and service options. If you do not have an active Internet connection, you can find contact information on your purchase invoice, packing slip, bill, or Dell product catalog. Availability varies by country and product, and some services may not be available in your area. To contact Dell for sales, technical support, or customer-service issues:

1. Go to **dell.com/support**.
2. Select your country from the drop-down menu on the bottom right corner of the page.
3. For customized support:
 - a. Enter your system Service Tag in the **Enter your Service Tag** field.
 - b. Click **Submit**.The support page that lists the various support categories is displayed.
4. For general support:
 - a. Select your product category.
 - b. Select your product segment.
 - c. Select your product.The support page that lists the various support categories is displayed.

Locating your system Service Tag

Your system is identified by a unique Express Service Code and Service Tag number. The Express Service Code and Service Tag are found on the front of the system by pulling out the information tag. Alternatively, the information may be on a sticker on the chassis of the system. This information is used by Dell to route support calls to the appropriate personnel.

Documentation feedback

If you have feedback for this document, write to **documentation_feedback@dell.com**. Alternatively, you can click on the **Feedback** link in any of the Dell documentation pages, fill out the form, and click **Submit** to send your feedback.

Quick Resource Locator (QRL)

Use the Quick Resource Locator (QRL) to get immediate access to system information and how-to videos. This can be done by visiting **dell.com/QRL** or by using your smartphone or tablet and a model specific Quick Resource (QR) code located on your Dell PowerEdge system. To try out the QR code, scan the following image.



Figure 59. Quick Resource Locator